



TAOGLAS®



Datasheet

Part No:
GPSDSF.35.7.A.08

Description:
Embedded 2in1 Low Profile Stacked Patch for GPS/GLONASS/Galileo & SDARS

Features:
GPS/Galileo L1 and GLONASS G1 SDARS, Operation
1575.42MHz, 1602MHz, 2338.75 Resonance
Dimensions: 35*35*7mm
Pin type Ceramic Patch Antenna
RoHS & REACH Compliant

1. Introduction	3
2. Specifications	4
3. Antenna Characteristics	5
4. Antenna Radiation Pattern	9
5. Mechanical Drawing	12
6. PCB Footprint Recommendation	14
7. Antenna Integration Guide	15
8. Evaluation Board Mechanical Drawing	20
9. Packaging	21
Changelog	22

Taoglas makes no warranties based on the accuracy or completeness of the contents of this document and reserves the right to make changes to specifications and product descriptions at any time without notice. Taoglas reserves all rights to this document and the information contained herein. Reproduction, use or disclosure to third parties without express permission is strictly prohibited.



1. Introduction



The GPSDSF.35.7.A.08 is a passive 35x35mm ceramic stacked patch antenna with both SDARS and GNSS capabilities. This patch provides world-class performance for both SDARS and GNSS services, with AR GPS:5.0 dB typ, GLONASS: 7.5 dB typ. SDARS(XM): 3.8 dB typ right hand circular polarization and nearly 70% efficiency at 2332.5 MHz for SDARS and 70-80% efficiency at GPS/GLONASS/GALILEO frequencies. Using one patch for both services results in the most economical and space-efficient solution for demanding applications requiring both SDARS and GNSS functionality. At just 7.15 mm in height, the GPSDSF.35 is also extremely low-profile.

Typical Applications:

- OEM Sharkfin Automotive Antennas
- Truck Mounted Antenna Systems

This antenna has been tuned and tested on a 70 x 70 mm ground plane. Custom tuning services can be provided for further optimization to customer-specific device environments. Contact your regional Taoglas sales office for support.

For further optimization to customer specific device environments where positioning is off center or a different ground-plane size, custom tuned patch antennas can be supplied. For more information, please contact your regional Taoglas customer support team.

2. Specifications

Electrical			
Application Bands	GPS/GALILEO	GLONASS	SDARS
Operation Frequency	1575.42 ±1.023MHz	1602±5MHz	2338.75±6.25MHz
VSWR	1.92 max		
Efficiency	69.78%	78.28%	67%
Peak Gain	3.4dBi	3.6dBi	4.7dBi
Polarization	R.H.C.P		L.H.C.P
Impedance	50 ohms		
Mechanical			
Dimension	35 x 35 x 7.15 mm GPS: 35 x 35 x 4 mm SDARS: 25 x 25 x 3 mm		
Material	Ceramic		
Pin Diameter	Ø0.8 mm		
Pin Length	2.4mm		
Weight	22.1g		
Environmental			
Operation Temperature	-40°C to 85°C		
Humidity	Non-condensing 65°C 95% RH		
Moisture Sensitivity	Level 3		

* Antenna properties were measured with the antenna mounted on 70*70mm Ground Plane

3. Antenna Characteristics

3.1 Return Loss

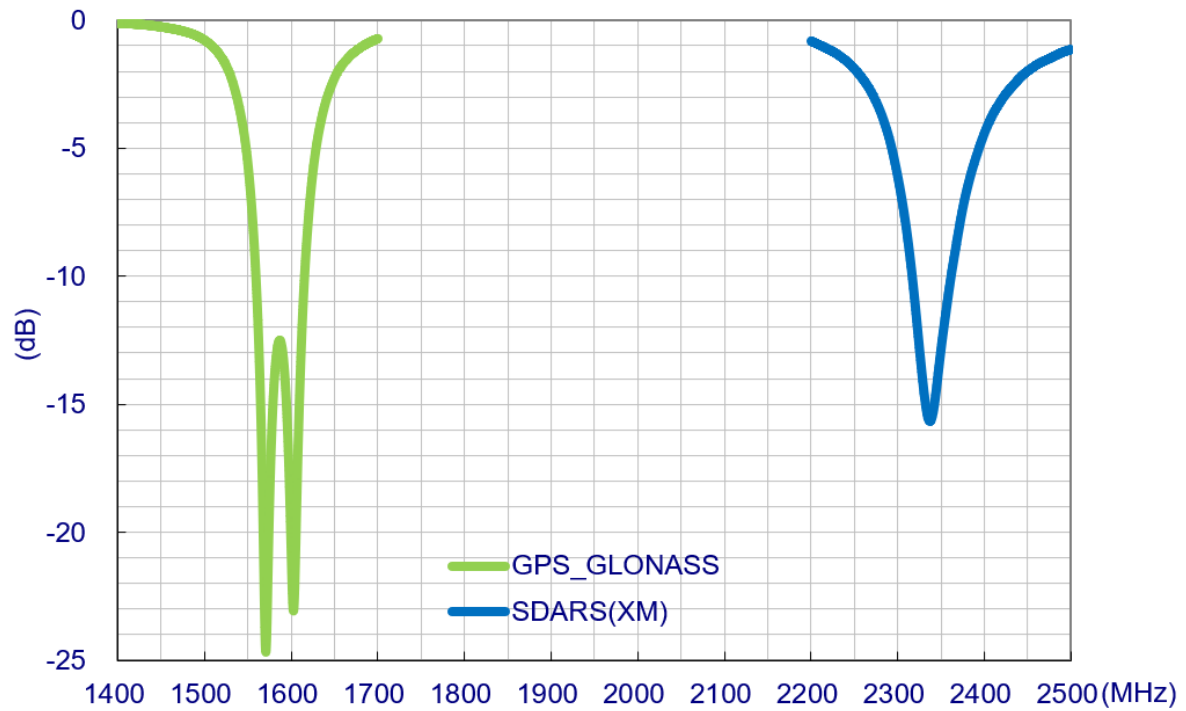

3.2 Efficiency

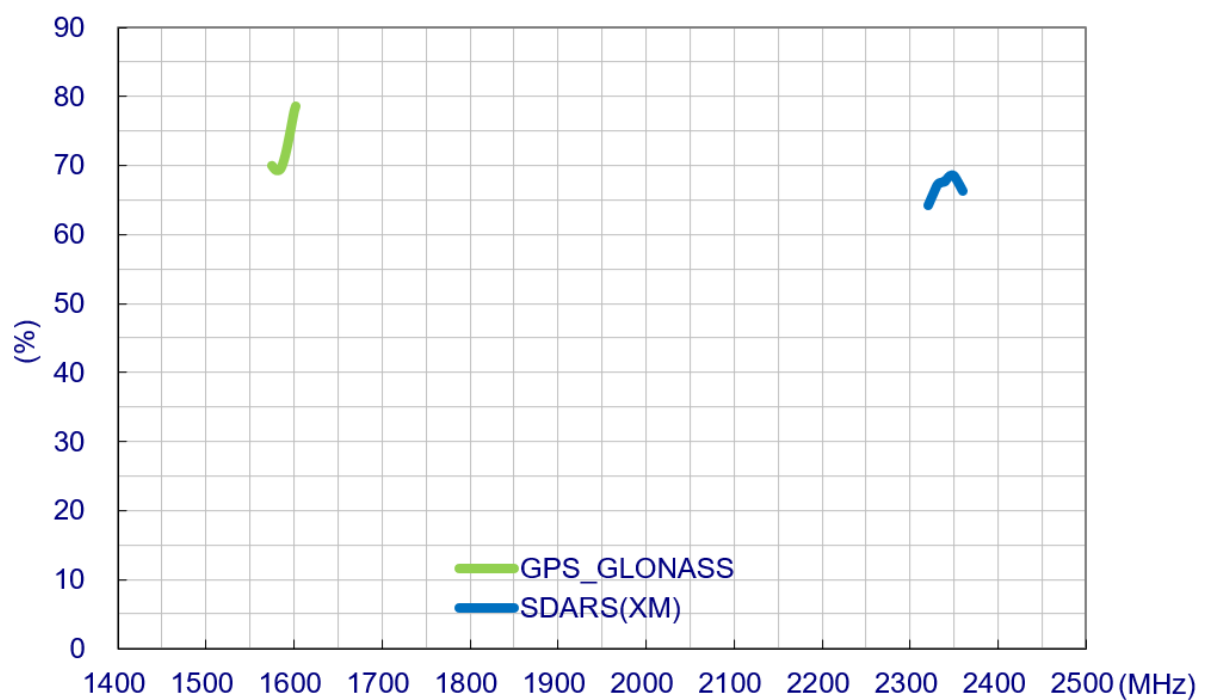

3.3 Average Gain

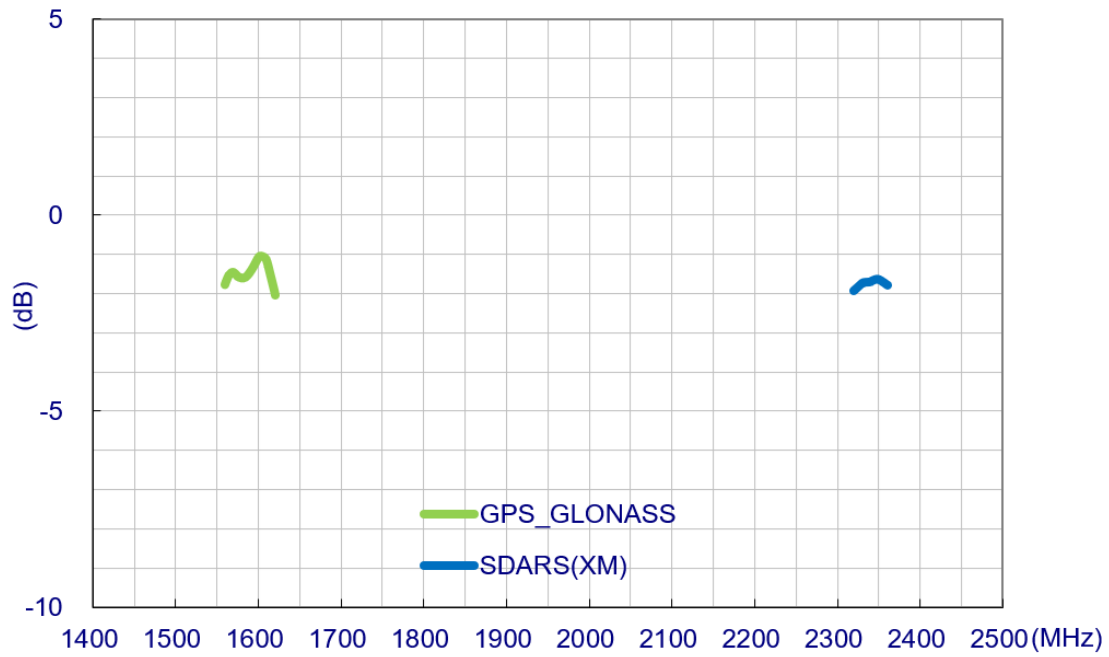

3.4 Peak Gain

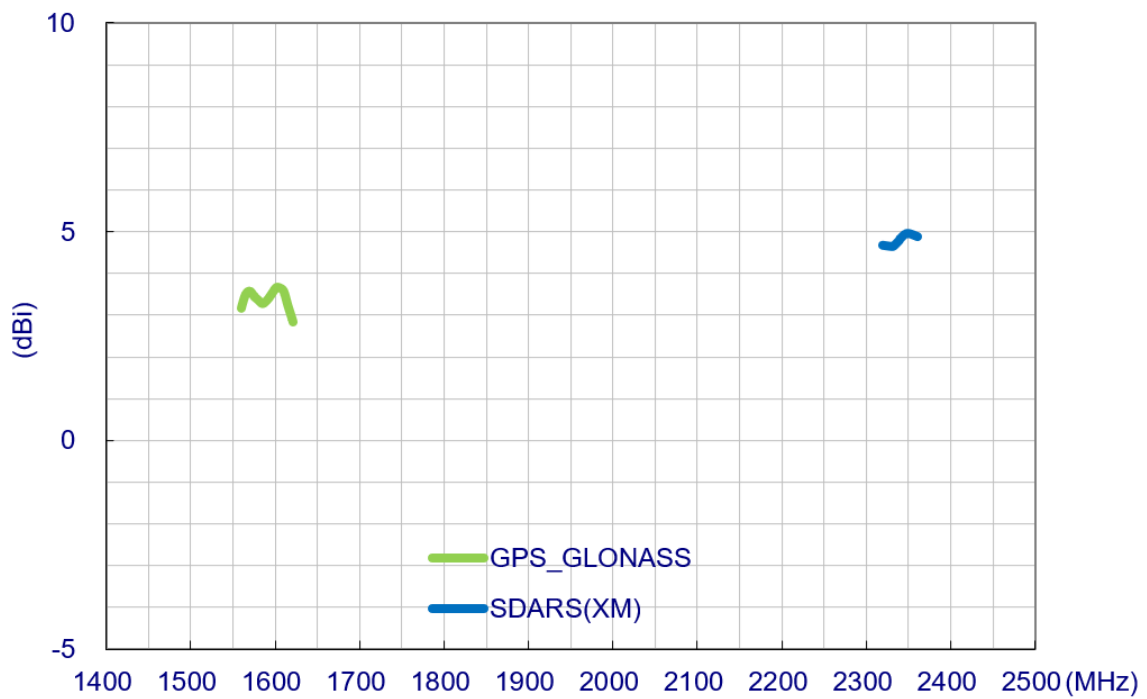

3.5 Axial Ratio (Zenith is at 0°)

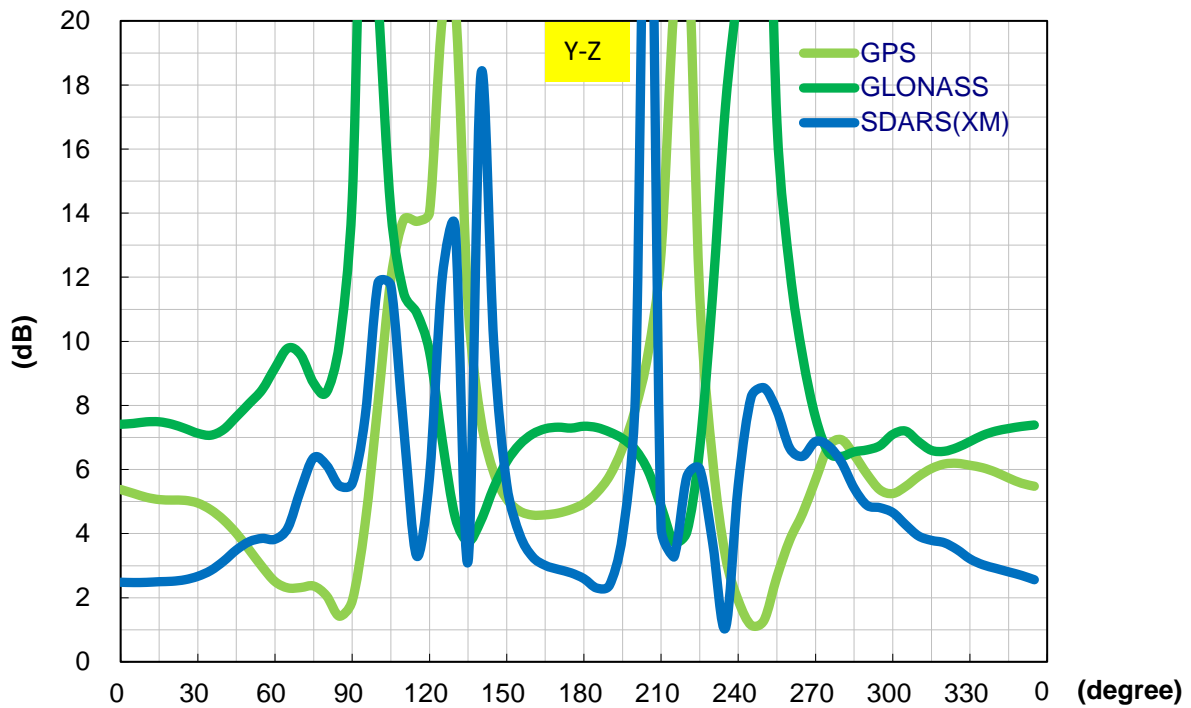
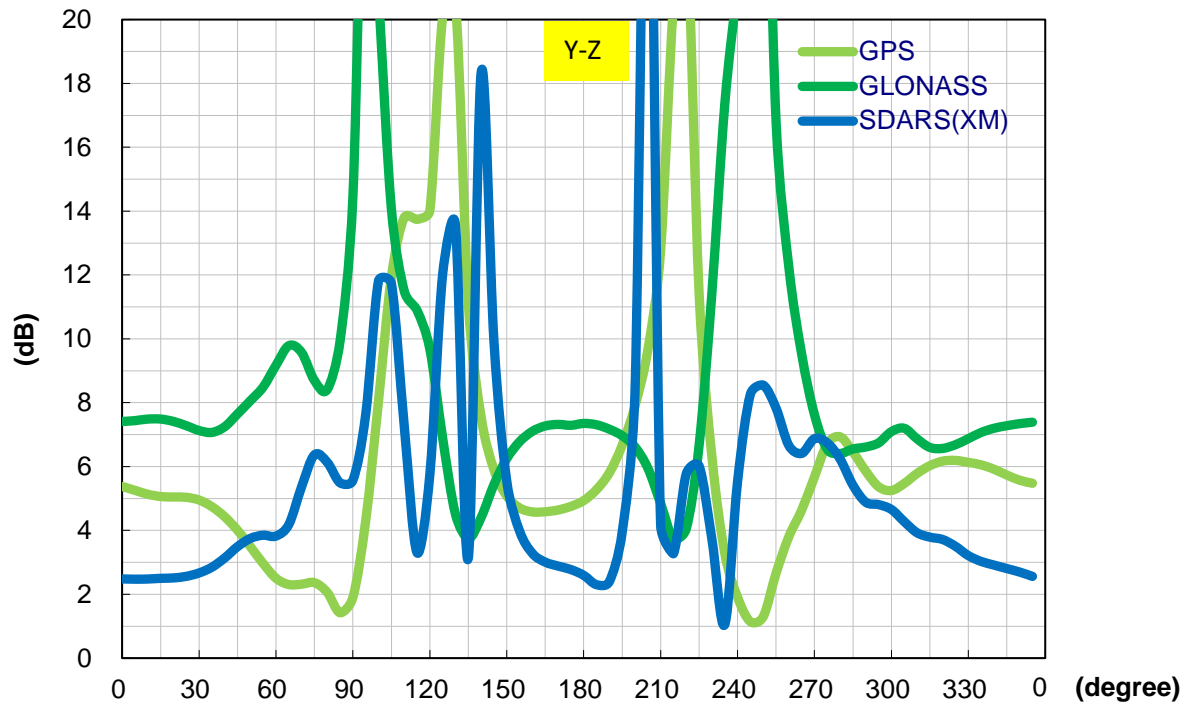

3.6 Isolation

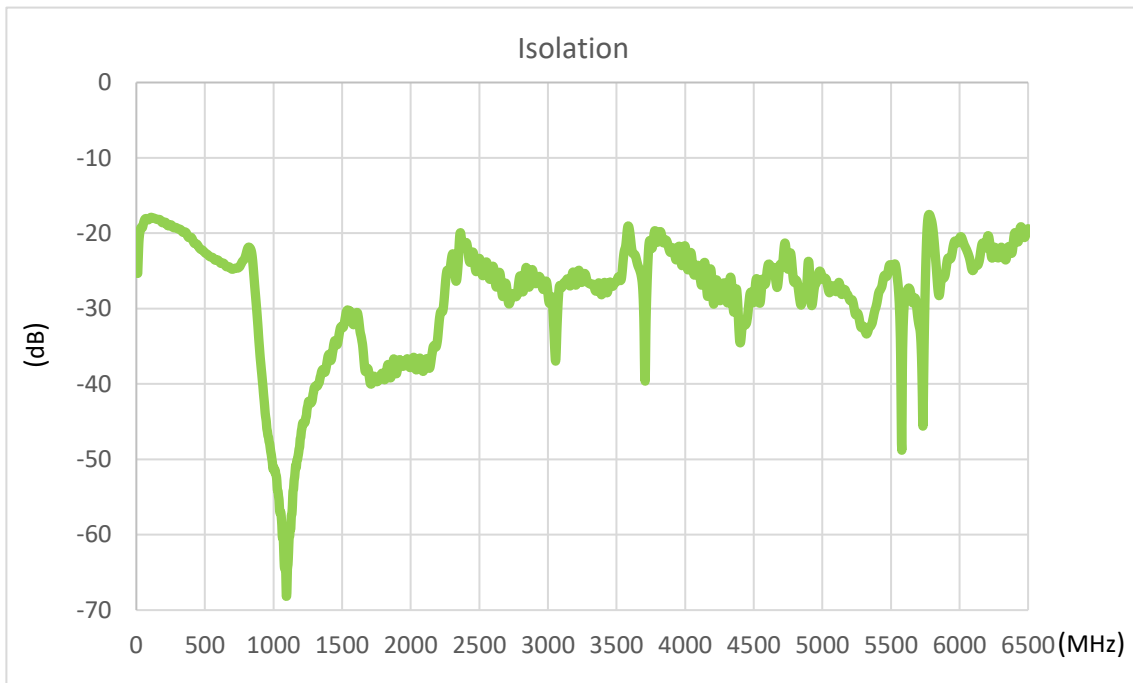

3.7 XM Gain Requirements (Satellite) – Ground Plane

AUT Location	Elevation Angle(degrees)	Linear Average Gain(dBic)
Passive Ground Plane	$20 \leq \phi \leq 25$	-1.3
	$25 \leq \phi \leq 30$	-0.7
	$30 \leq \phi \leq 50$	0.8
	$50 \leq \phi \leq 70$	2.9
	$70 \leq \phi \leq 90$	3.9

3.8 XM Gain Requirements (Terrestrial) – Ground Plane

AUT Location	Elevation Angle(degrees)	Antenna Mean Passive VP Gain Over Solid Angle (dBi)Gain(dBic)	Antenna P/P Gain variation (dB)
Passive Ground Plane	$0^\circ \leq \phi \leq 10^\circ$	-5.7	-
	$\Phi = 5^\circ$	-	4.3

4. Antenna Radiation Pattern

4.1 Setup

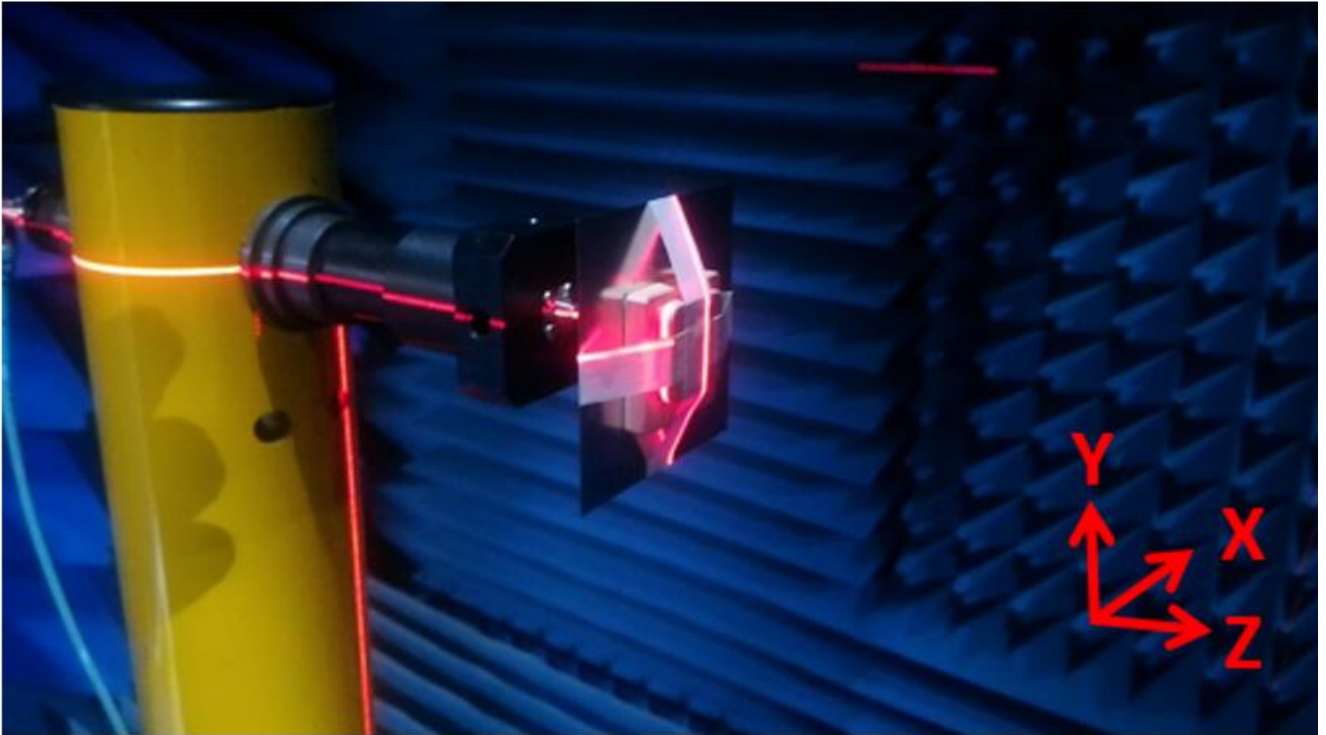

4.2 2D Radiation Patter

XY Plane

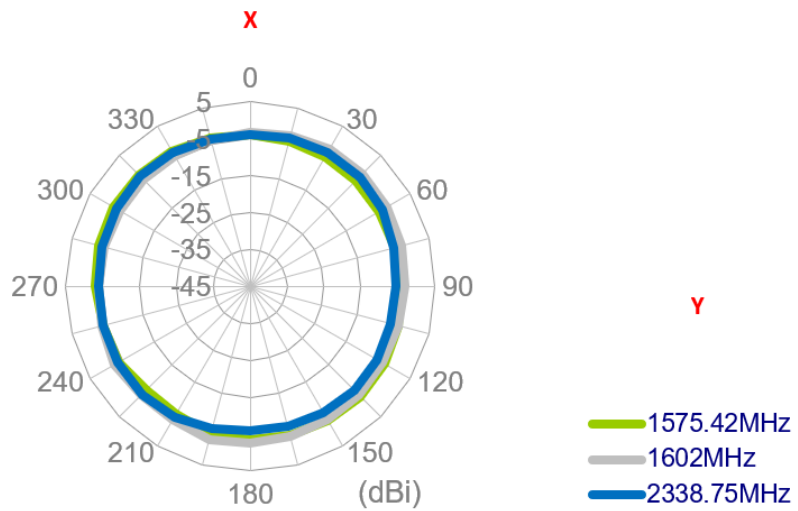

XZ Plane

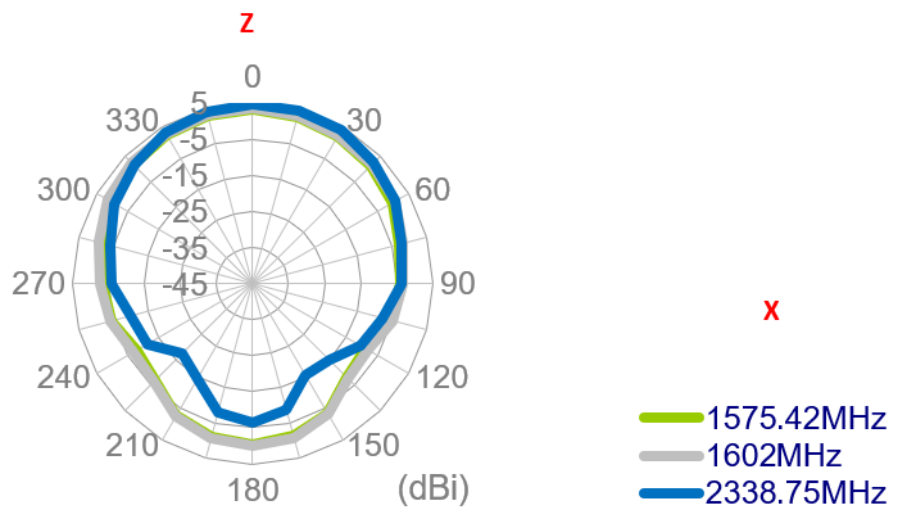

XZ Plane

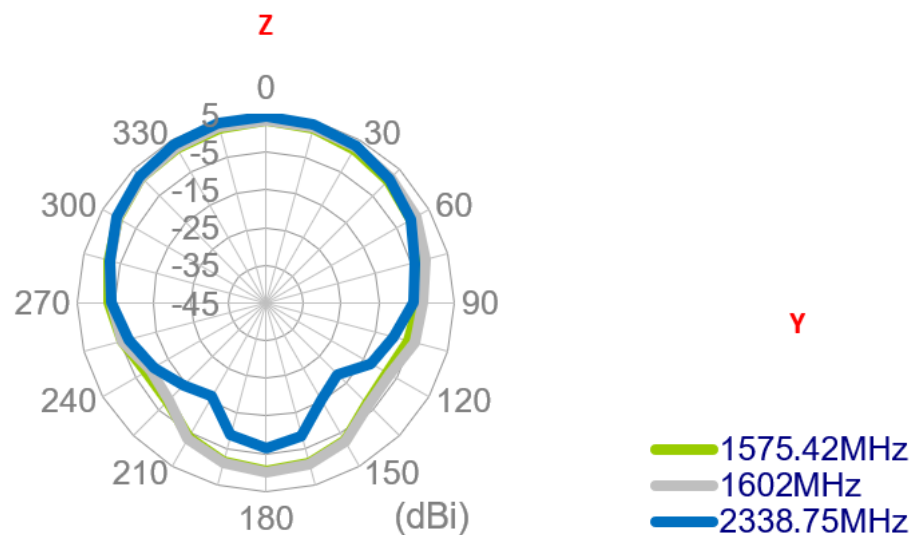

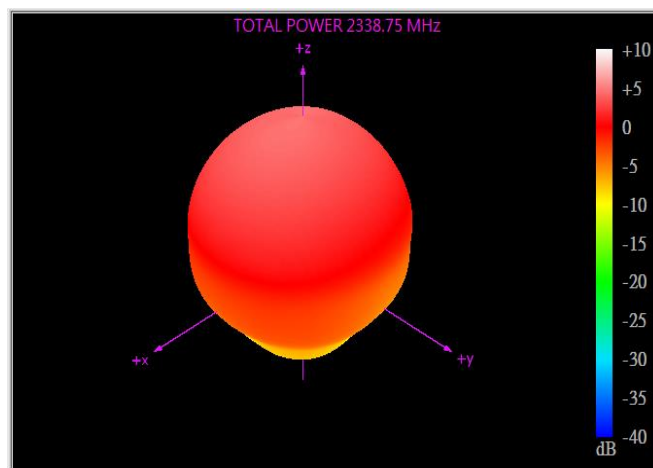
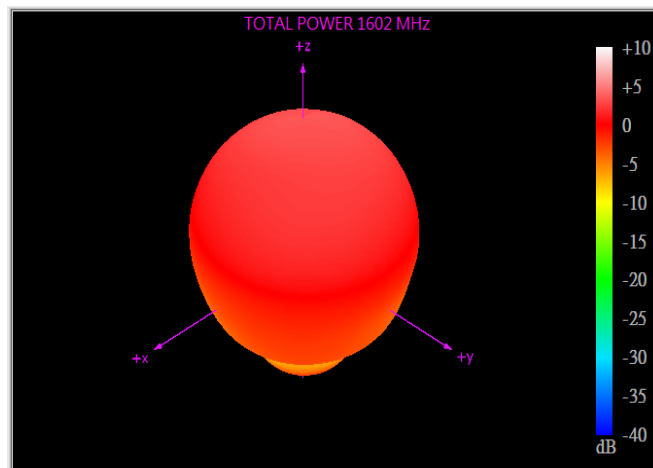
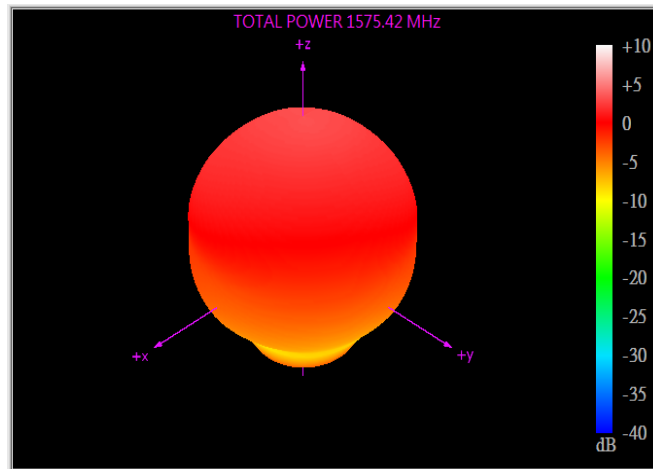

4.3 3D Radiation Patter

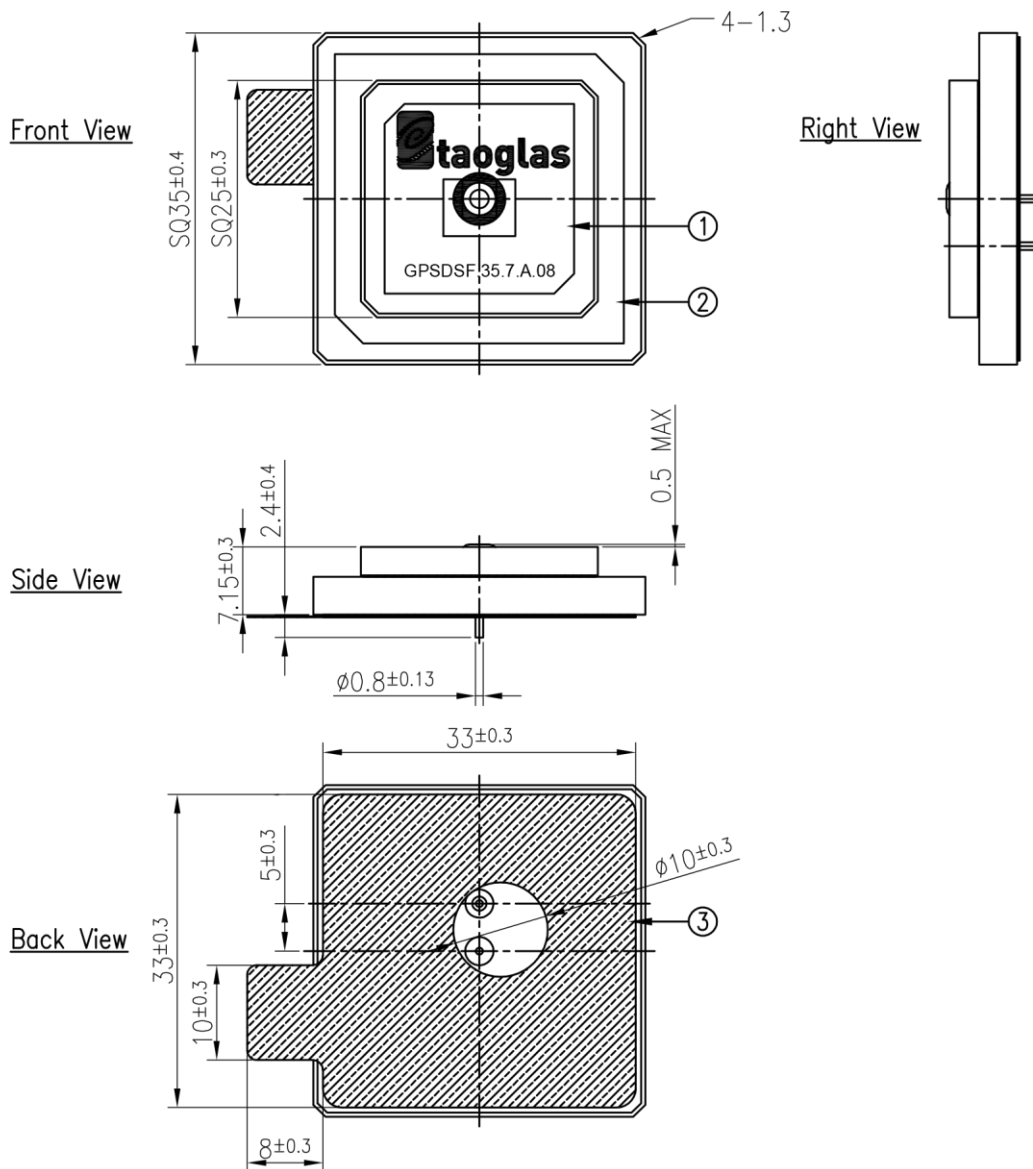

5. Mechanical Drawing (Unit: mm)



NOTES: 1. Double Sided Adhesive Area. 
 2. Soldermask Area 

	Name	P/N	Material	Finish	QTY
1	Patch-1 (25x25x3mm)	001517J120000A	Ceramic	Clear	1
2	Patch-2 (35x35x4mm)	001517J130000A	Ceramic	Clear	1
3	Double Sided Adhesive	001517J130000A	NITTO 5015	White Linter	1

5.2 Adhesive Thickness

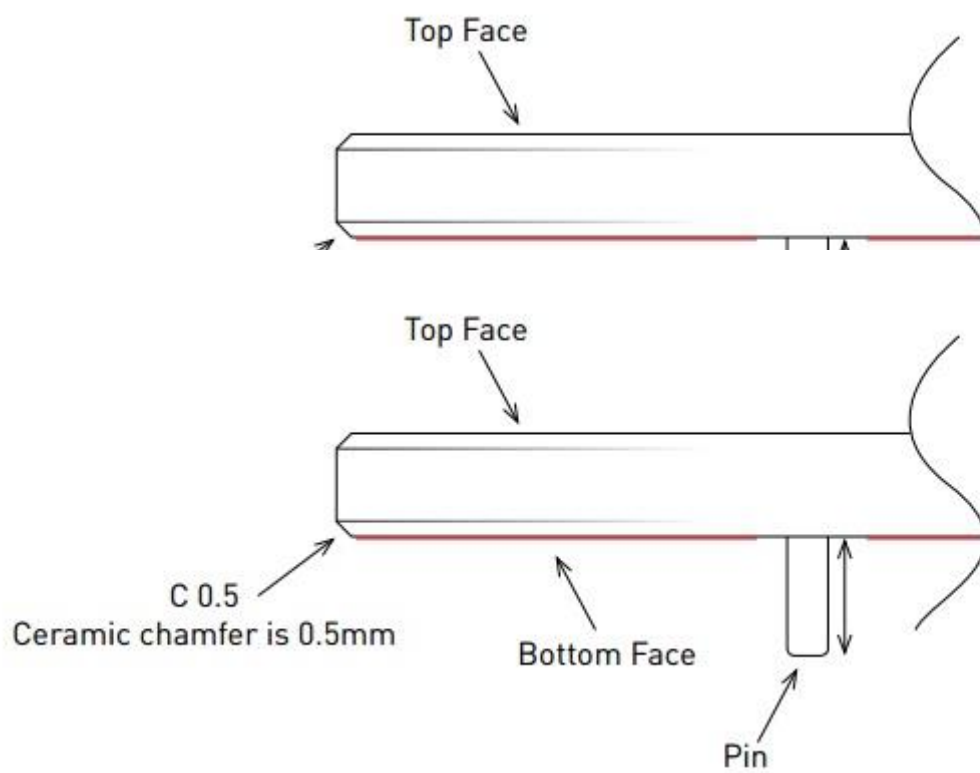

Red Line shows the adhesive without Liner – thickness 0.08-0.1mm

6. PCB Footprint Recommendation

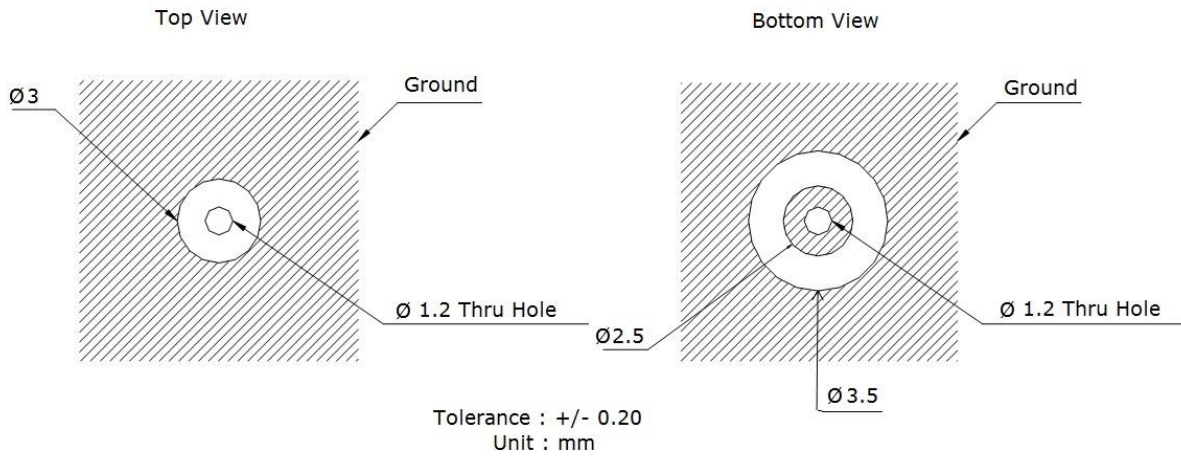

7. Antenna Integration Guide



7.1 Schematic Symbol and Pin Definition

The circuit symbol for the antenna is shown below. The antenna has 2 pins as indicated below. The L1 pin represents the lower frequency bands at 1559 - 1610MHz and the SDARS pin represents the higher frequency bands at 2320 to 2345MHz

Pin	Description
1	GPS L1
2	SDARS

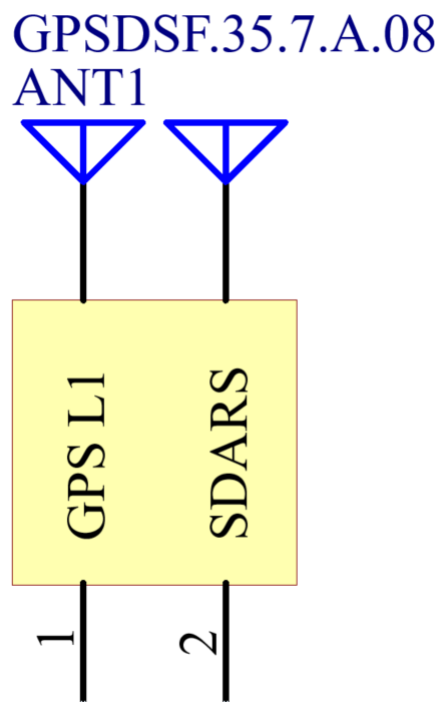

7.2 Antenna Integration

The antenna should be placed at the center of the ground plane with a length and width of 70mm. Maintaining a square symmetric ground plane shape and symmetric environment around the antenna is critical to maintaining the excellent axial ratio and phase center performance shown in this datasheet.

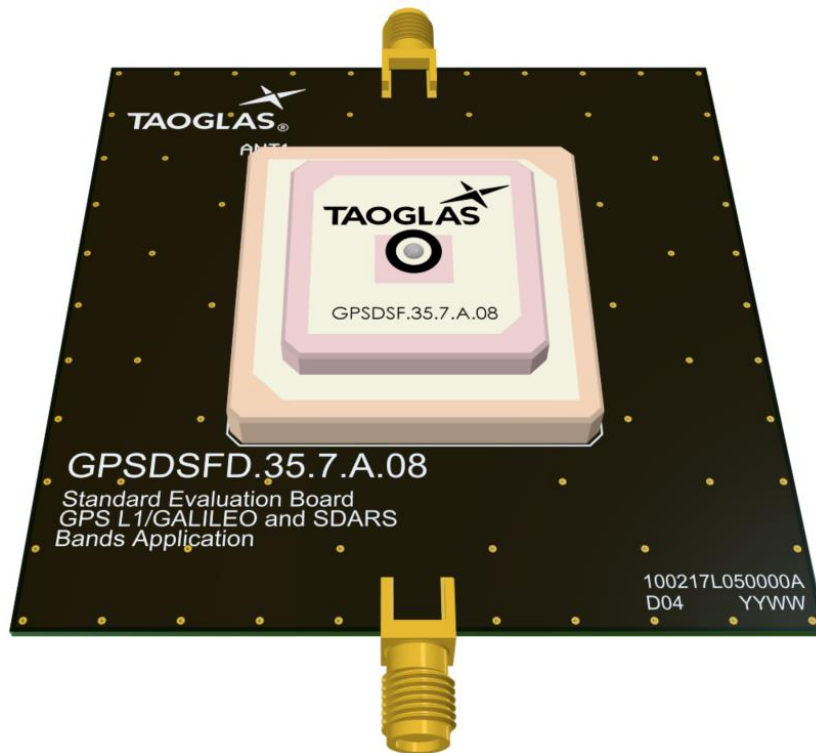

Top Side w/ Solder Mask

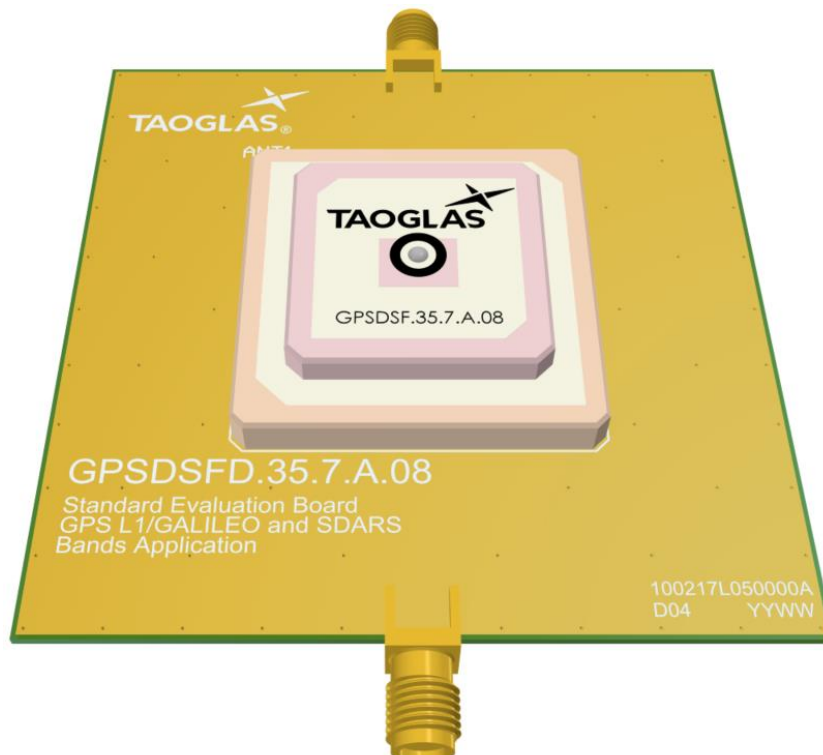

Top Side w/o Solder Mask

7.3 PCB Layout

The footprint and clearance on the PCB must comply with the antenna specification. The PCB layout shown in the diagram below demonstrates the antenna footprint.



Topside

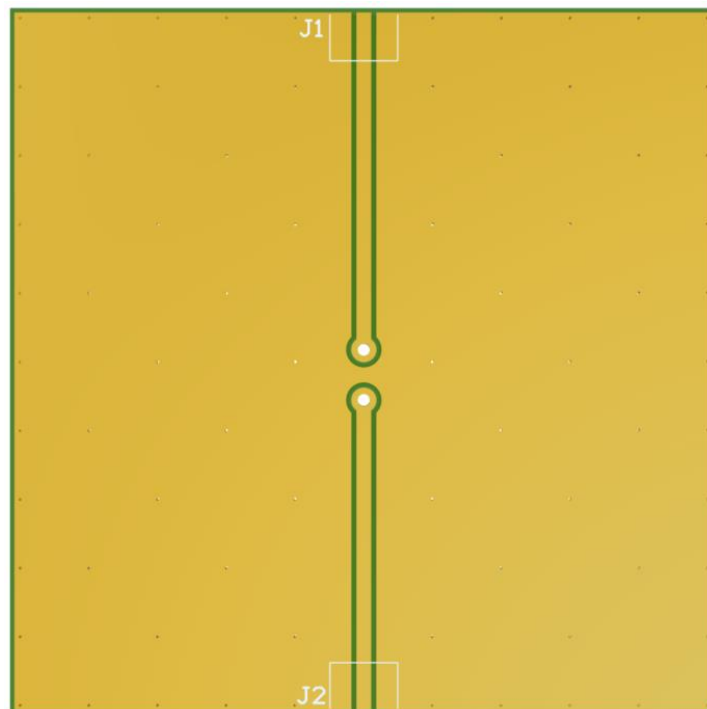

Bottom Side

7.4 Evaluation Board

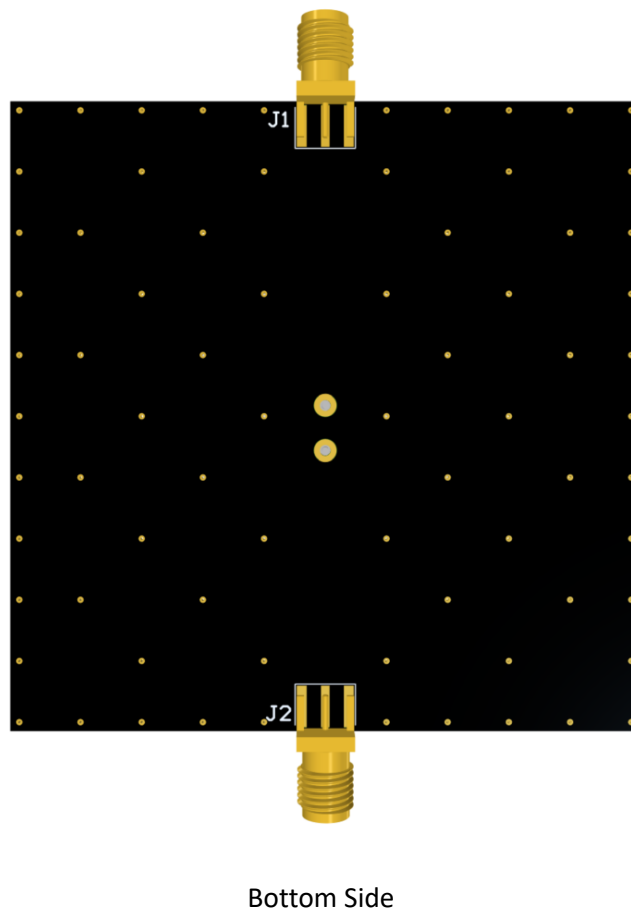
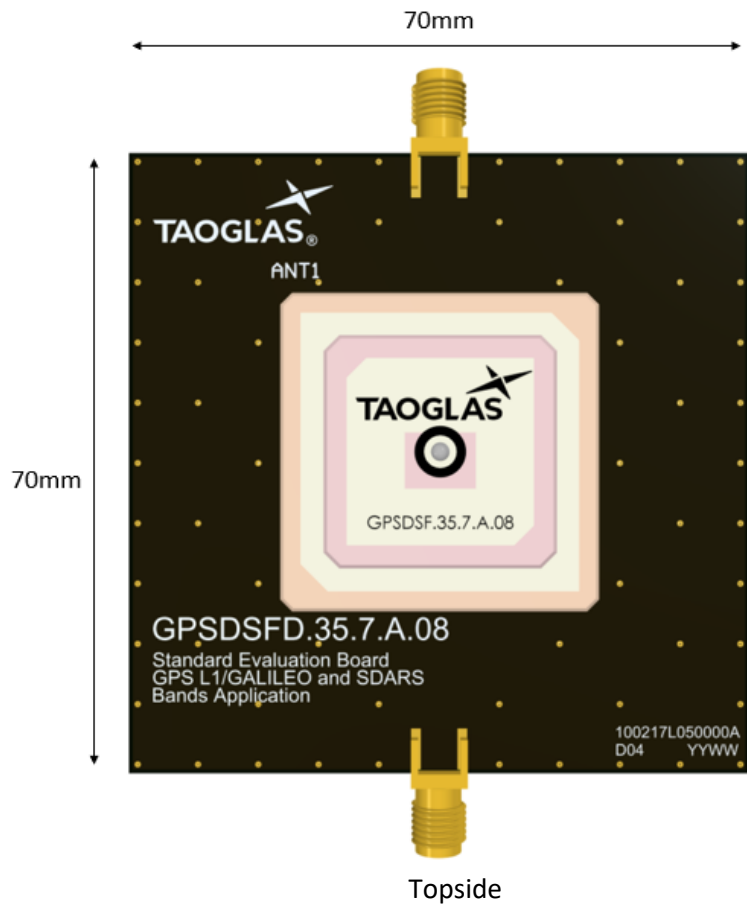

8. Evaluation Board Mechanical Drawing

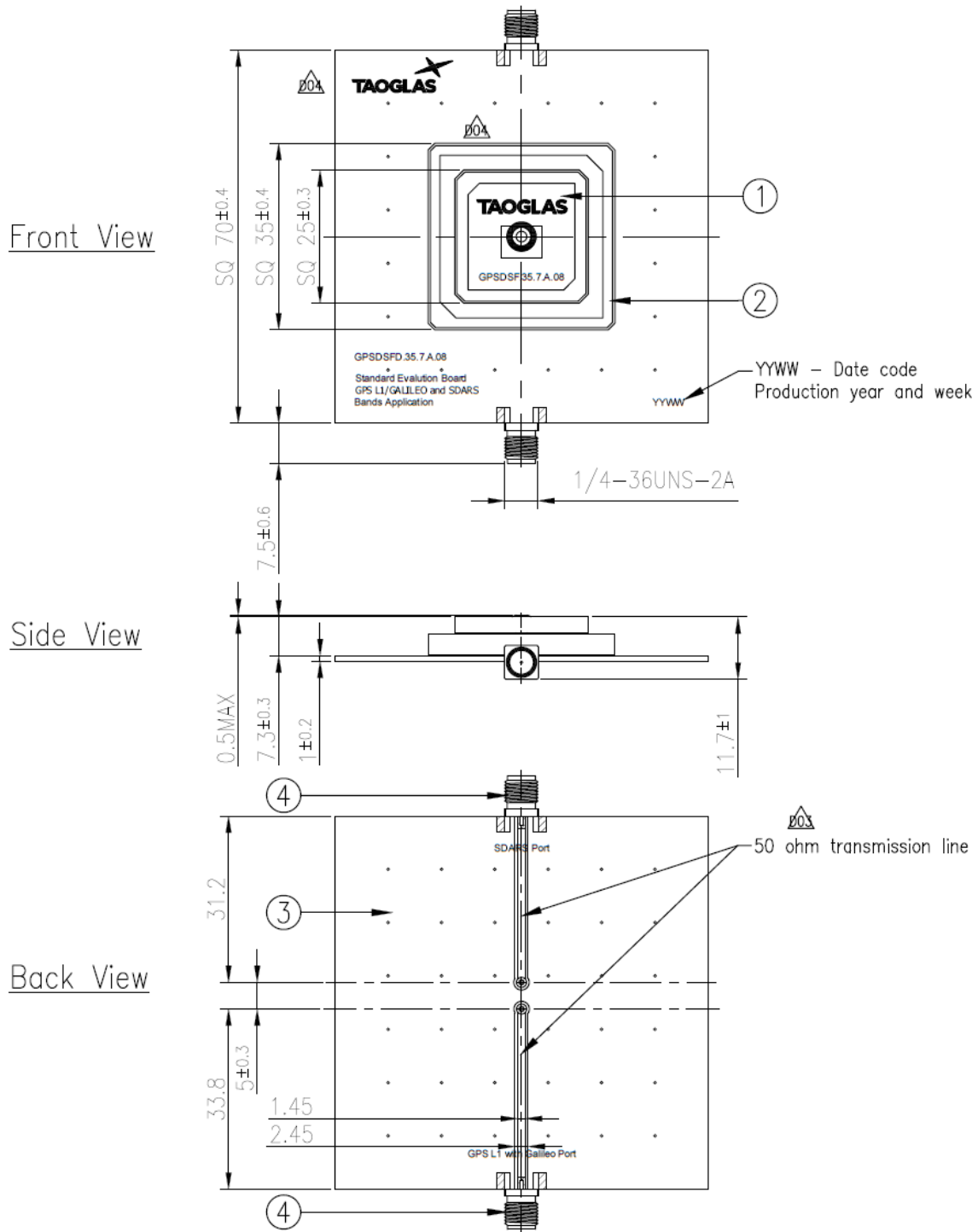

NOTES:

- 1. Soldermask Area
- 2. Soldered Area

	Name	P/N	Material	Finish	QTY
1	Patch-1 (25x25x3mm)	001517J120000A	Ceramic	Clear	1
2	Patch-2 (35x35x4mm)	001517J130000A	Ceramic	Clear	1
3	PCB	100217L050000A	Composite 1t	Black	1
4	SMA(F)ST	200417L00006FA	Brass	Au Plated	2

9. Packaging

30 pcs GPSDSF.35.7.A.08 per Tray
 Tray Dimensions - 300*370*30mm
 Weight - 848g

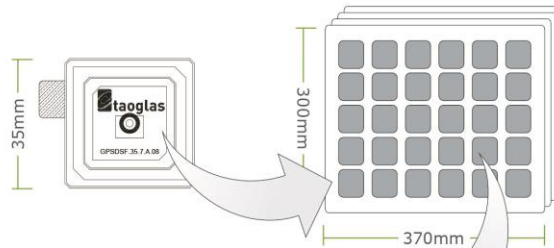

120 pcs GPSDSF.35.7.A.08 per Vacuum Bag
 Vacuum Bag Dimensions - 300*370*50mm
 Weight - 3.4kg

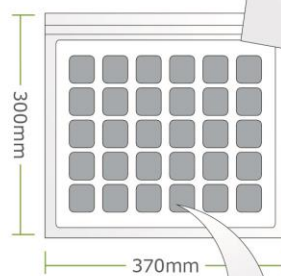

360 pcs GPSDSF.35.7.A.08 per Carton
 Carton Dimensions - 390*320*270mm
 Weight - 13.07kg

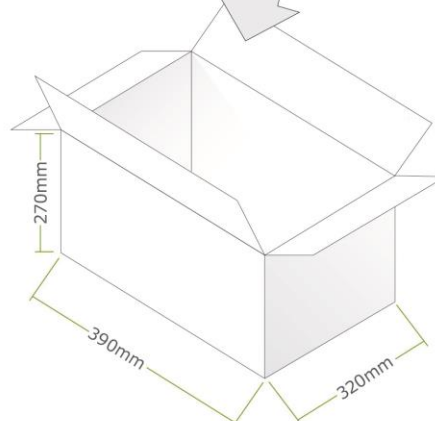

Pallet Dimensions:
 1200mm*1000mm*1280mm
 36 Cartons per Pallet
 9 Cartons per Layer, 4 Layers

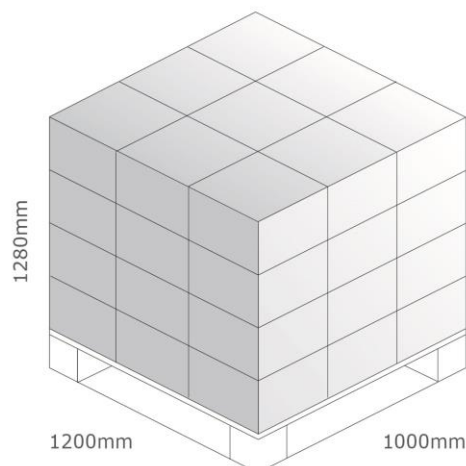

Changelog for the datasheet

SPE-18-8-078 – GPSDSF.35.7.A.08

Revision: D (Current Version)

Date:	2023-03-28
Changes:	Antenna Integration Guide Added
Changes Made by:	Cesar Sousa

Previous Revisions

Revision: C

Date:	2021-06-21
Changes:	Updated specification
Changes Made by:	Dan Cantwell

Revision: B

Date:	2018-11-21
Changes:	Mechanical drawing updated
Changes Made by:	Jack Conroy

Revision: A (Original First Release)

Date:	2018-08-17
Notes:	
Author:	Jack Conroy



TAOGLAS®

www.taoglas.com

