

OSRAM GP JTLPS1.14

Datasheet

Published by **ams-OSRAM AG**

Tobelbader Strasse 30, 8141 Premstaetten, Austria

Phone +43 3136 500-0

ams-osram.com

© All rights reserved



DURIS® E 2835

GP JTLPS1.14

The DURIS® E 2835 color family provide supreme efficacy in cost effective industry standard LED. DURIS® E 2835 never fails to impress with its performance on system level.



Applications

- Agriculture & Horticulture
- Entertainment
- Indoor Lighting

Features

- Package: white SMT package, colored diffused silicone resin
- Typ. Radiation: 120° (Lambertian emitter)
- ESD: 2 kV acc. to ANSI/ESDA/JEDEC JS-001 (HBM, Class 2)
- Radiant Flux: typ. 203 mW
- Radiant Efficiency: typ. 48%
- Photosynthetic Photon Flux: typ. 0.93 $\mu\text{mol/s}$
- Photon Efficacy: typ. 2.56 $\mu\text{mol/J}$

Ordering Information

Type	Total radiant flux ¹⁾ $I_F = 150 \text{ mA}$ Φ_E	Ordering Code
GP JTLPS1.14-M2N1-P1P2-1	190 ... 290 mW	Q65113A1493

Maximum Ratings

Parameter	Symbol		Values
Operating Temperature	T_{op}	min.	-40 °C
		max.	100 °C
Storage Temperature	T_{stg}	min.	-40 °C
		max.	100 °C
Junction Temperature	T_j	max.	125 °C
Forward current	I_F	min.	10 mA
		max.	350 mA
Surge Current $t \leq 10 \mu s$; $D = 0.005$; $T_j = 25 \text{ °C}$	I_{FS}	max.	500 mA
ESD withstand voltage acc. to ANSI/ESDA/JEDEC JS-001 (HBM, Class 2)	V_{ESD}		2 kV

Note: Ensure the appropriate derating current is being used in order to maintain a junction temperature which is lower than the maximum allowable limit.

Characteristics

$I_F = 150 \text{ mA}$; $T_J = 25 \text{ °C}$

Parameter	Symbol		Values
Viewing angle at 50% I_V	2ϕ	typ.	120 °
Forward Voltage ²⁾ $I_F = 150 \text{ mA}$	V_F	min. typ. max.	2.7 V 2.9 V 3.0 V
Reverse current ³⁾	I_R		Not designed for reverse operation
Electrical thermal resistance junction/solderpoint with efficiency $\eta_e = 48 \%$	$R_{thJS \text{ elec.}}$	typ.	14 K / W

Brightness Groups

Group	Total radiant flux ¹⁾ $I_F = 150 \text{ mA}$ min. Φ_E	Total radiant flux ¹⁾ $I_F = 150 \text{ mA}$ max. Φ_E	PPF * min. Φ_p	PPF * max. Φ_p	PPF/W * typ.	PF ** min. $\Phi_{p,b}$	PF ** max. $\Phi_{p,b}$	PF/W ** typ.
M2	190 mW	200 mW	0.80 $\mu\text{mol/s}$	0.84 $\mu\text{mol/s}$	1.91 $\mu\text{mol/J}$	1.02 $\mu\text{mol/s}$	1.07 $\mu\text{mol/s}$	2.44 $\mu\text{mol/J}$
M3	200 mW	210 mW	0.84 $\mu\text{mol/s}$	0.89 $\mu\text{mol/s}$	2.01 $\mu\text{mol/J}$	1.07 $\mu\text{mol/s}$	1.13 $\mu\text{mol/s}$	2.56 $\mu\text{mol/J}$
M4	210 mW	220 mW	0.89 $\mu\text{mol/s}$	0.93 $\mu\text{mol/s}$	2.11 $\mu\text{mol/J}$	1.13 $\mu\text{mol/s}$	1.18 $\mu\text{mol/s}$	2.69 $\mu\text{mol/J}$
M5	220 mW	230 mW	0.93 $\mu\text{mol/s}$	0.97 $\mu\text{mol/s}$	2.21 $\mu\text{mol/J}$	1.18 $\mu\text{mol/s}$	1.23 $\mu\text{mol/s}$	2.81 $\mu\text{mol/J}$
M6	230 mW	240 mW	0.97 $\mu\text{mol/s}$	1.01 $\mu\text{mol/s}$	2.31 $\mu\text{mol/J}$	1.23 $\mu\text{mol/s}$	1.29 $\mu\text{mol/s}$	2.94 $\mu\text{mol/J}$
M7	240 mW	250 mW	1.01 $\mu\text{mol/s}$	1.05 $\mu\text{mol/s}$	2.40 $\mu\text{mol/J}$	1.29 $\mu\text{mol/s}$	1.34 $\mu\text{mol/s}$	3.07 $\mu\text{mol/J}$
M8	250 mW	260 mW	1.05 $\mu\text{mol/s}$	1.10 $\mu\text{mol/s}$	2.51 $\mu\text{mol/J}$	1.34 $\mu\text{mol/s}$	1.40 $\mu\text{mol/s}$	3.19 $\mu\text{mol/J}$
M9	260 mW	270 mW	1.10 $\mu\text{mol/s}$	1.14 $\mu\text{mol/s}$	2.61 $\mu\text{mol/J}$	1.40 $\mu\text{mol/s}$	1.45 $\mu\text{mol/s}$	3.32 $\mu\text{mol/J}$
MF	270 mW	280 mW	1.14 $\mu\text{mol/s}$	1.18 $\mu\text{mol/s}$	2.70 $\mu\text{mol/J}$	1.45 $\mu\text{mol/s}$	1.50 $\mu\text{mol/s}$	3.44 $\mu\text{mol/J}$
N1	280 mW	290 mW	1.18 $\mu\text{mol/s}$	1.22 $\mu\text{mol/s}$	2.80 $\mu\text{mol/J}$	1.50 $\mu\text{mol/s}$	1.56 $\mu\text{mol/s}$	3.57 $\mu\text{mol/J}$

Note: [*] Photosynthetic Photon Flux includes wavelengths between 400 and 700 nm

Note: [**] Photon Flux includes wavelengths between 280 and 800 nm

Note: PPF and PF values are for reference only

Forward Voltage Groups

Group	Forward Voltage ²⁾ $I_F = 150 \text{ mA}$ min. V_F	Forward Voltage ²⁾ $I_F = 150 \text{ mA}$ max. V_F
K2	2.7 V	2.8 V
L1	2.8 V	2.9 V
L2	2.9 V	3.0 V

Chromaticity Coordinate Groups ⁴⁾

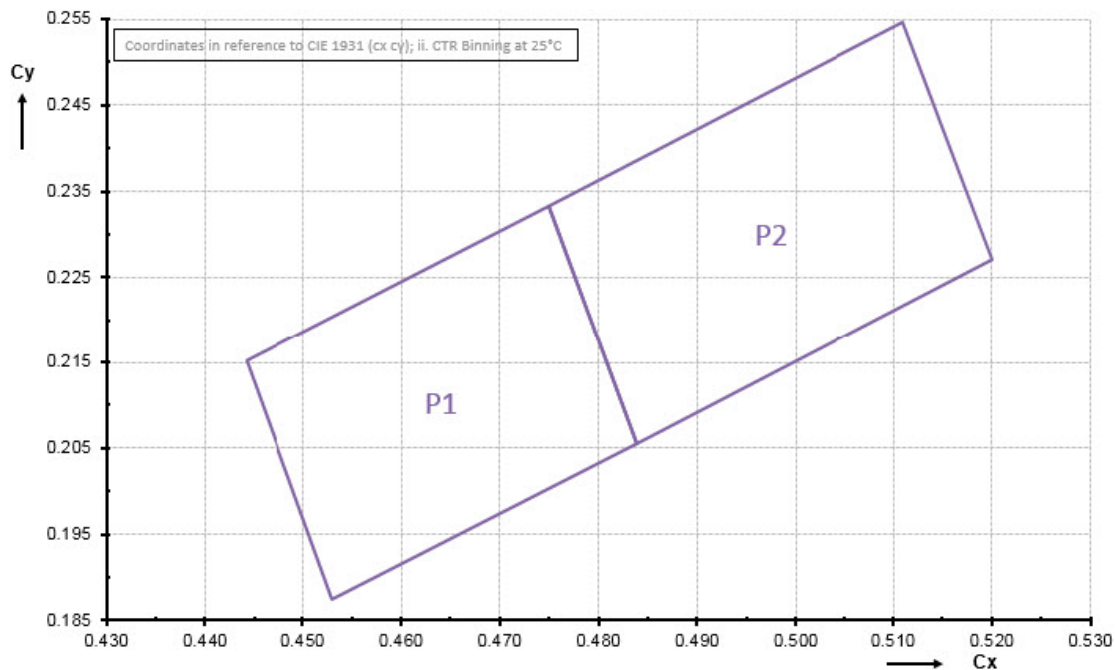

Chromaticity Coordinate Groups

Group	Cx	Cy	Group	Cx	Cy
P1	0.4443	0.2152	P2	0.4750	0.2333
	0.4530	0.1875		0.4839	0.2055
	0.4839	0.2055		0.5200	0.2270
	0.4750	0.2333		0.5110	0.2547

Group Name on Label

Example: M2-P1-K2

Brightness	Color Chromaticity	Forward Voltage
M2	P1	K2

Relative Spectral Emission ⁵⁾

$I_{rel} = f(\lambda)$; $I_F = 150 \text{ mA}$; $T_J = 25 \text{ }^\circ\text{C}$

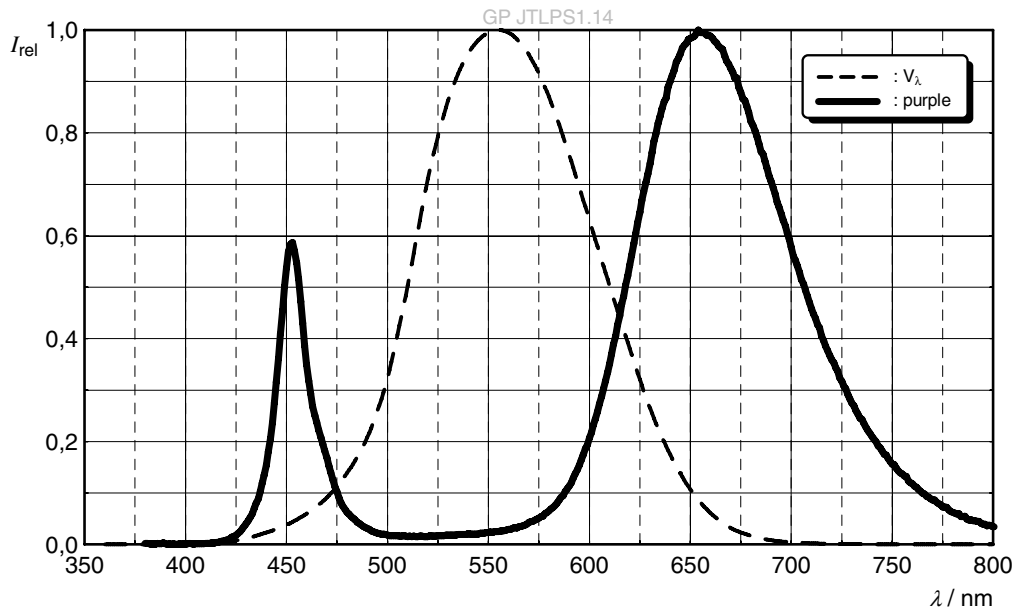

Radiation Characteristics ⁵⁾

$I_{rel} = f(\phi)$; $T_J = 25 \text{ }^\circ\text{C}$

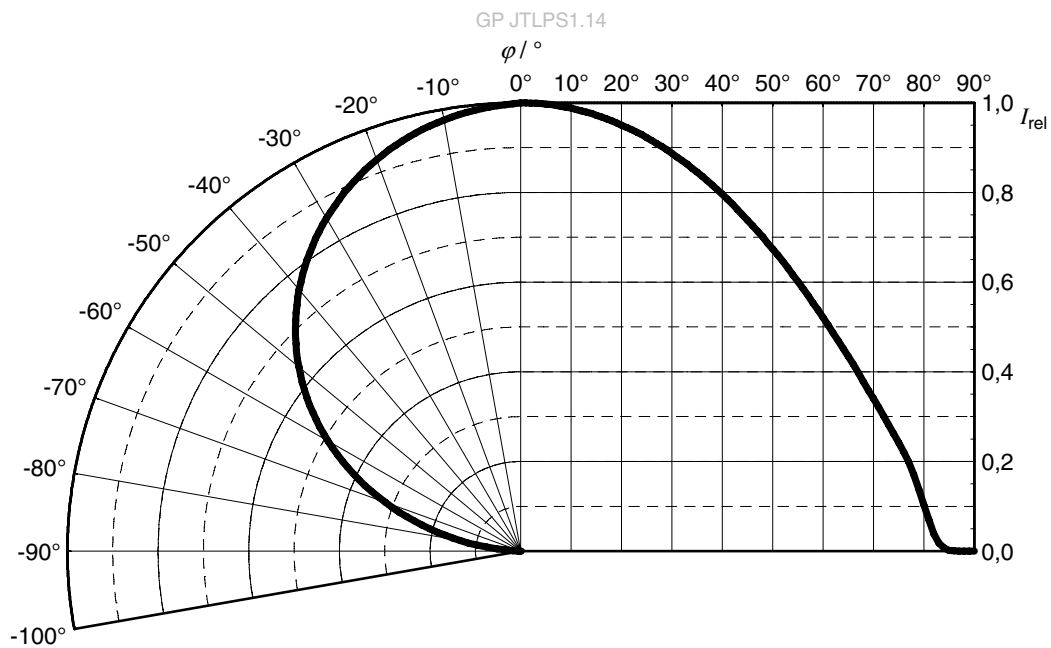

Forward current ⁵⁾

$I_F = f(V_F); T_J = 25\text{ °C}$

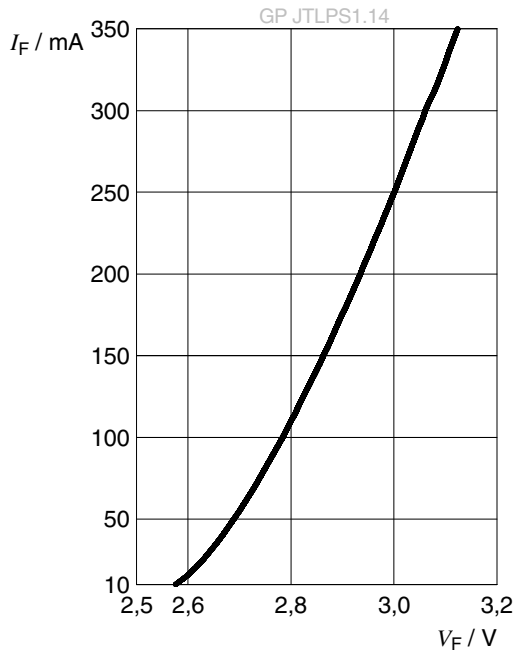

Relative Radiant Power ^{5), 6)}

$\Phi_E / \Phi_E(150\text{ mA}) = f(I_F); T_J = 25\text{ °C}$

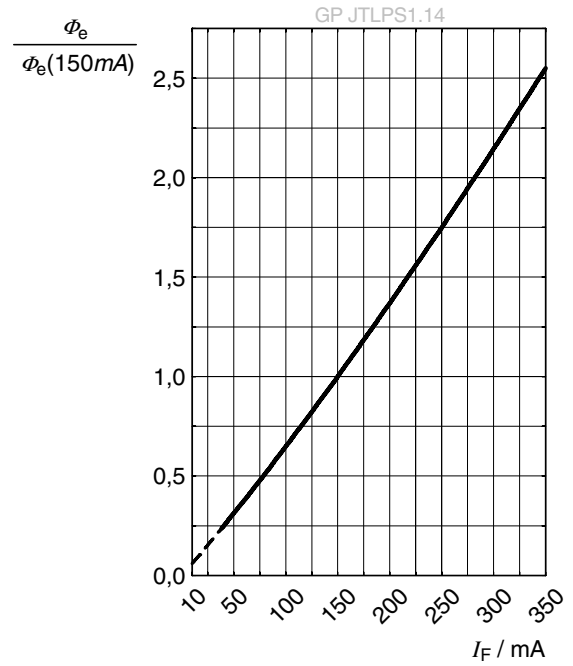

Chromaticity Coordinate Shift ⁵⁾

$\Delta Cx, \Delta Cy = f(I_F); T_J = 25\text{ °C}$

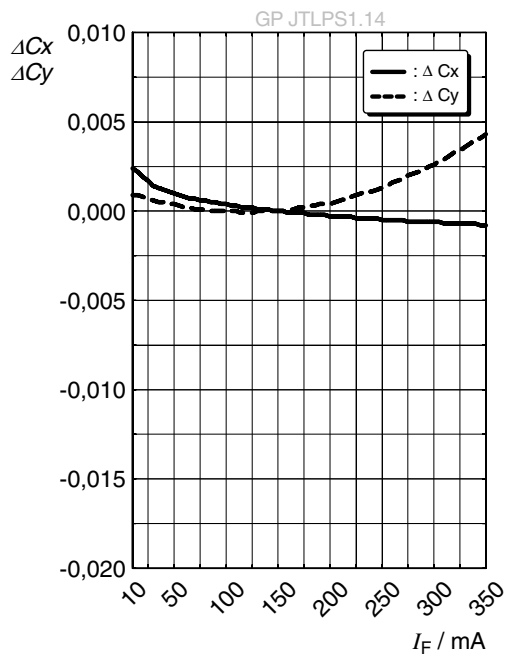

Forward Voltage ⁵⁾

$$\Delta V_F = V_F - V_F(25\text{ }^\circ\text{C}) = f(T_j); I_F = 150\text{ mA}$$

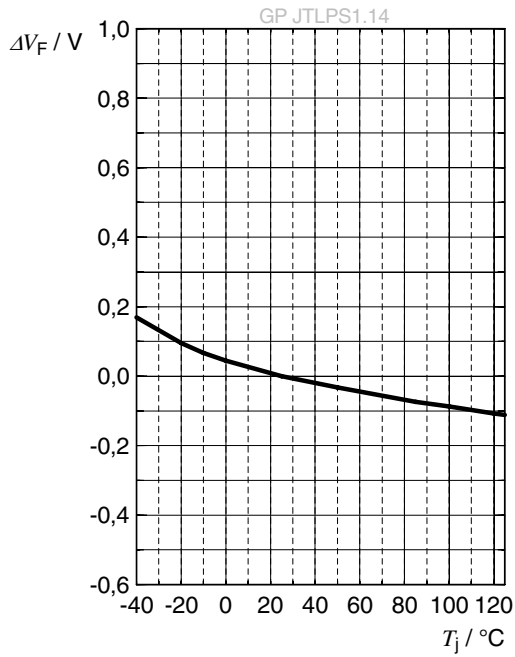

Relative Radiant Power ⁵⁾

$$\Phi_E / \Phi_E(25\text{ }^\circ\text{C}) = f(T_j); I_F = 150\text{ mA}$$

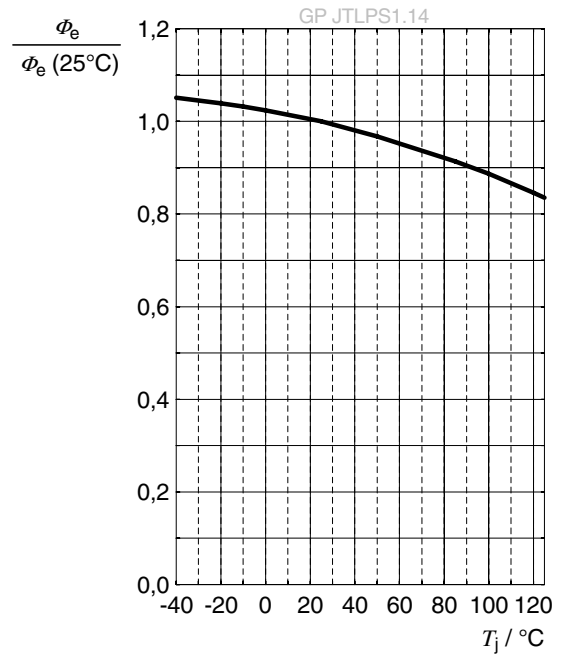

Chromaticity Coordinate Shift ⁵⁾

$$\Delta C_x, \Delta C_y = f(T_j); I_F = 150\text{ mA}$$

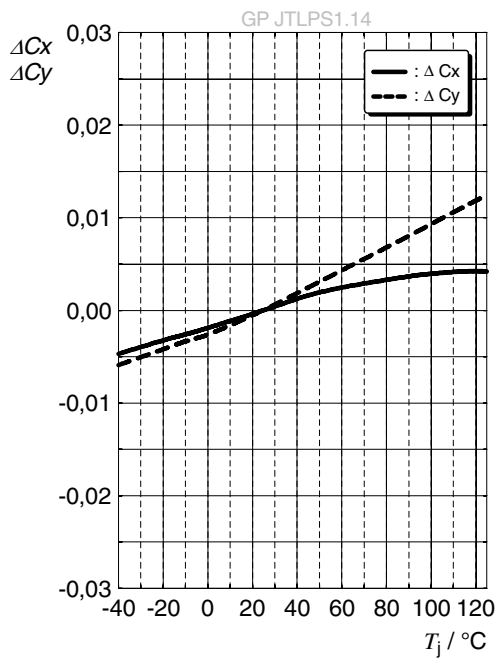

Max. Permissible Forward Current

$$I_F = f(T)$$

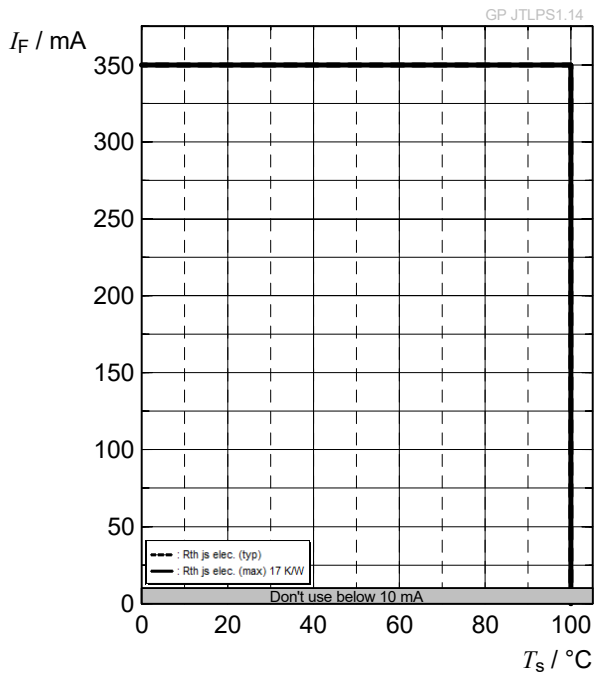

Dimensional Drawing ⁷⁾

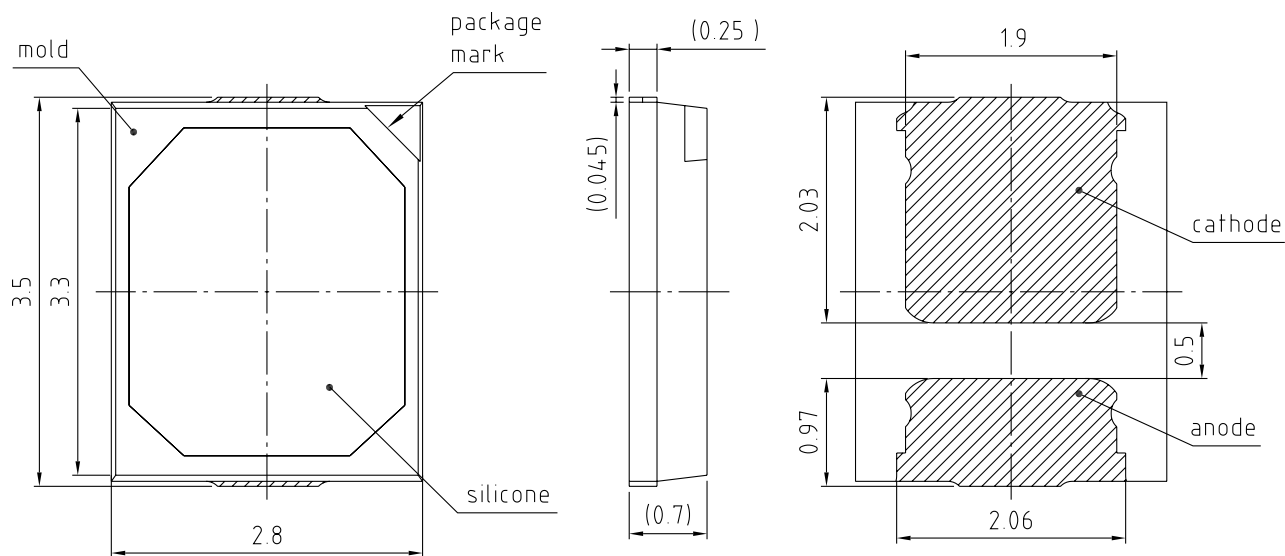

general tolerance ± 0.1

lead finish Ag 

C67062-A0354-A2-01

Further Information:

Approximate Weight: 20.0 mg

Package marking: Cathode

Recommended Solder Pad ⁷⁾

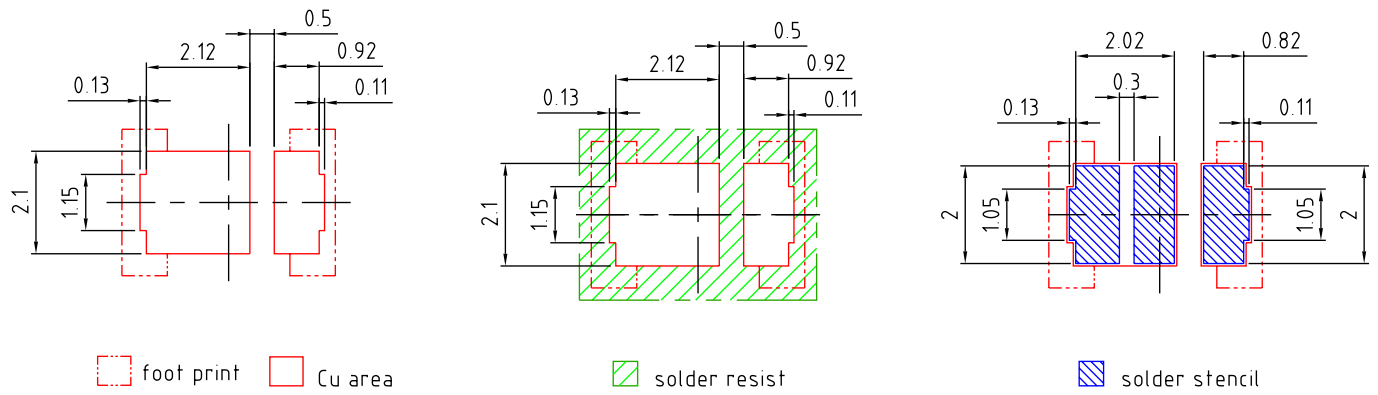

E067.0346.04-01

For superior solder joint connectivity results we recommend soldering under standard nitrogen atmosphere. Package not suitable for ultra sonic cleaning.

Reflow Soldering Profile

Product complies to MSL Level 3 acc. to JEDEC J-STD-020E



Profile Feature	Symbol	Pb-Free (SnAgCu) Assembly			Unit
		Minimum	Recommendation	Maximum	
Ramp-up rate to preheat ^{*)} 25 °C to 150 °C			2	3	K/s
Time t_s T_{Smin} to T_{Smax}	t_s	60	100	120	s
Ramp-up rate to peak ^{*)} T_{Smax} to T_p			2	3	K/s
Liquidus temperature	T_L		217		°C
Time above liquidus temperature	t_L		80	100	s
Peak temperature	T_p		245	260	°C
Time within 5 °C of the specified peak temperature $T_p - 5$ K	t_p	10	20	30	s
Ramp-down rate* T_p to 100 °C			3	6	K/s
Time 25 °C to T_p				480	s

All temperatures refer to the center of the package, measured on the top of the component

* slope calculation DT/Dt : Dt max. 5 s; fulfillment for the whole T-range

Taping ⁷⁾

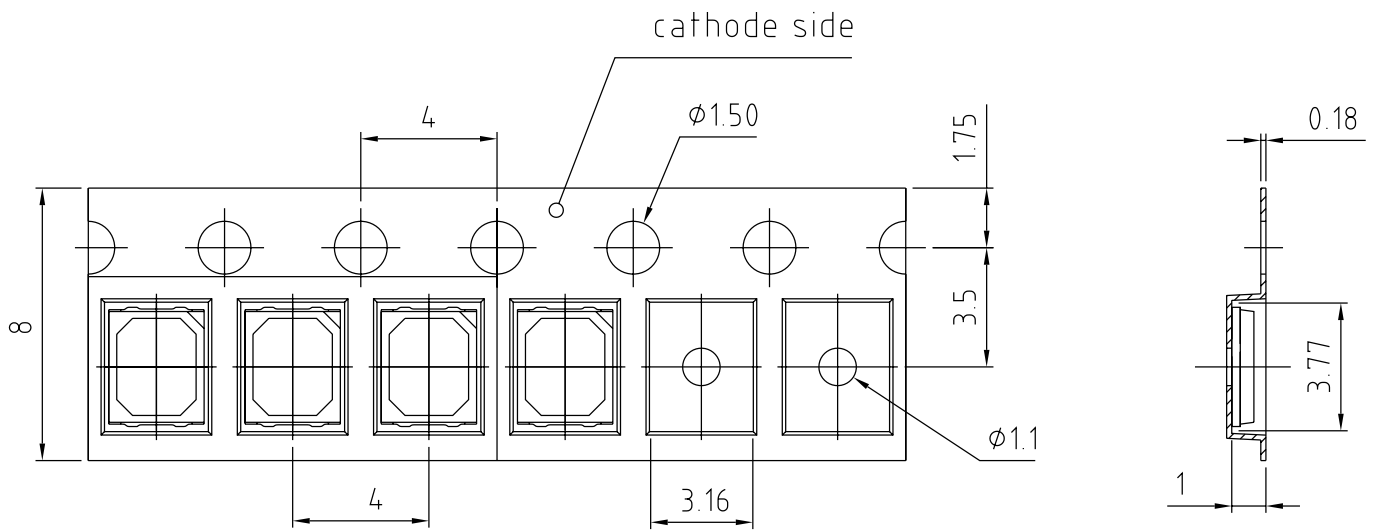

C67062-A0319-B3-01

Tape and Reel ⁸⁾

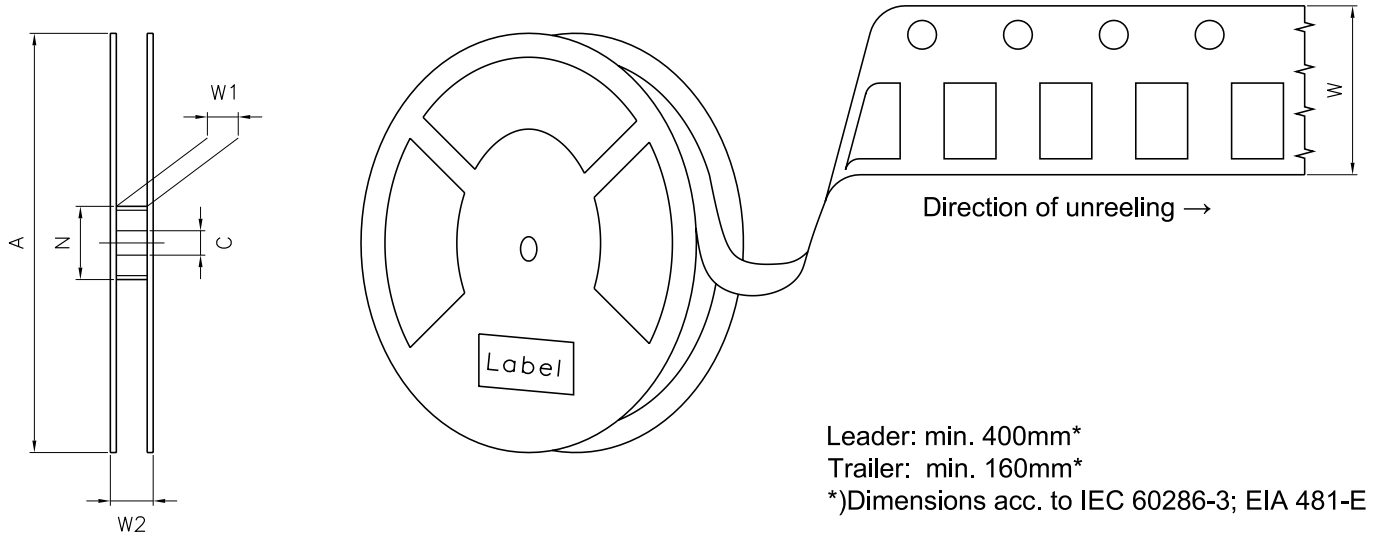

Reel Dimensions

A	W	N_{\min}	W_1	$W_{2\max}$	Pieces per PU
330 mm	$8 + 0.3 / - 0.1$ mm	60 mm	$8.4 + 2$ mm	14.4 mm	10000

Barcode-Product-Label (BPL)

OSRAM LX XXXX BIN1: XX-XX-X-XXX-X





RoHS Compliant

(6P) BATCH NO: 1234567890 ML Temp ST
X XXX °C X

(1T) LOT NO: 1234567890 (9D) D/C: 1234

Pack: RXX
DEMY XXX
X_X123_1234.1234 X

(X) PROD NO: 123456789(Q)QTY: 9999 (G) GROUP: XX-XX-X-X

OHA04563

Dry Packing Process and Materials ⁷⁾

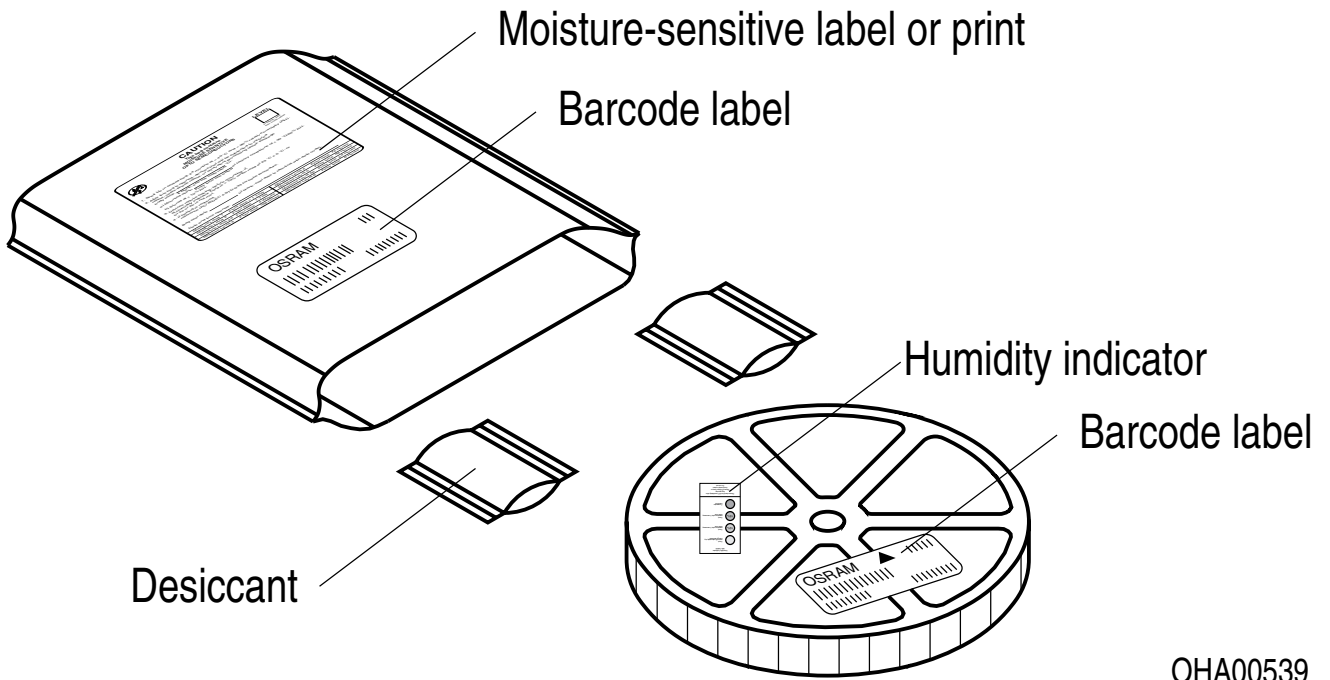

OHA00539

Moisture-sensitive product is packed in a dry bag containing desiccant and a humidity card according JEDEC-STD-033.

Notes

The evaluation of eye safety occurs according to the standard IEC 62471:2006 (photo biological safety of lamps and lamp systems). Within the risk grouping system of this IEC standard, the device specified in this data sheet fall into the class **low risk (exposure time 100 s)**. Under real circumstances (for exposure time, conditions of the eye pupils, observation distance), it is assumed that no endangerment to the eye exists from these devices. As a matter of principle, however, it should be mentioned that intense light sources have a high secondary exposure potential due to their blinding effect. When looking at bright light sources (e.g. headlights), temporary reduction in visual acuity and afterimages can occur, leading to irritation, annoyance, visual impairment, and even accidents, depending on the situation.

Subcomponents of this device contain, in addition to other substances, metal filled materials including silver. Metal filled materials can be affected by environments that contain traces of aggressive substances. Therefore, we recommend that customers minimize device exposure to aggressive substances during storage, production, and use. Devices that showed visible discoloration when tested using the described tests above did show no performance deviations within failure limits during the stated test duration. Respective failure limits are described in the IEC60810.

This device is designed for specific/recommended applications only. Please consult OSRAM Opto Semiconductors Sales Staff in advance for detailed information on other non-recommended applications (e.g. automotive).

Change management for this component is aligned with the requirements of the lighting market.

For further application related information please visit www.osram-os.com/appnotes

Disclaimer

Attention please!

The information describes the type of component and shall not be considered as assured characteristics. Terms of delivery and rights to change design reserved. Due to technical requirements components may contain dangerous substances.

For information on the types in question please contact our Sales Organization.

If printed or downloaded, please find the latest version on our website.

Packing

Please use the recycling operators known to you. We can also help you – get in touch with your nearest sales office. By agreement we will take packing material back, if it is sorted. You must bear the costs of transport. For packing material that is returned to us unsorted or which we are not obliged to accept, we shall have to invoice you for any costs incurred.

Product and functional safety devices/applications or medical devices/applications

Our components are not developed, constructed or tested for the application as safety relevant component or for the application in medical devices.

Our products are not qualified at module and system level for such application.

In case buyer – or customer supplied by buyer – considers using our components in product safety devices/ applications or medical devices/applications, buyer and/or customer has to inform our local sales partner immediately and we and buyer and /or customer will analyze and coordinate the customer-specific request between us and buyer and/or customer.

Glossary

- 1) **Brightness:** Brightness values are measured during a current pulse of typically 10 ms, with a tolerance of +/- 7%.
- 2) **Forward Voltage:** The Forward voltage is measured during a current pulse duration of typically 1 ms with a tolerance of $\pm 0.05V$.
- 3) **Reverse Operation:** Not designed for reverse operation. Continuous reverse operation can cause migration and damage of the device.
- 4) **Chromaticity coordinate groups:** Chromaticity coordinate groups are measured during a current pulse duration of typically 10ms with a tolerance of ± 0.005 .
- 5) **Typical Values:** Due to the special conditions of the manufacturing processes of semiconductor devices, the typical data or calculated correlations of technical parameters can only reflect statistical figures. These do not necessarily correspond to the actual parameters of each single product, which could differ from the typical data and calculated correlations or the typical characteristic line. If requested, e.g. because of technical improvements, these typ. data will be changed without any further notice.
- 6) **Characteristic curve:** In the range where the line of the graph is broken, you must expect higher differences between single devices within one packing unit.
- 7) **Tolerance of Measure:** Unless otherwise noted in drawing, tolerances are specified with ± 0.1 and dimensions are specified in mm.
- 8) **Tape and Reel:** All dimensions and tolerances are specified acc. IEC 60286-3 and specified in mm.

Revision History

Version	Date	Change
1.0	2020-07-28	Initial Version Characteristics
1.1	2020-09-02	Dimensional Drawing
1.2	2021-08-11	Brightness Groups
1.2	2023-02-23	New Layout Applications Maximum Ratings Derating (Diagrams)



EU RoHS and China RoHS compliant product

此产品符合欧盟 RoHS 指令的要求；
按照中国的相关法规和标准，
不含有毒有害物质或元素。

Published by ams-OSRAM AG

Tobelbader Strasse 30, 8141 Premstaetten, Austria

Phone +43 3136 500-0

ams-osram.com

© All rights reserved

