

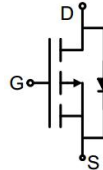
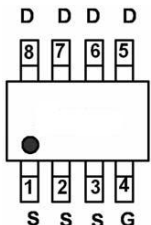

P-Channel Enhancement Mode Power MOSFET

<p>Description</p> <p>The GT700P08S uses advanced trench technology to provide excellent $R_{DS(ON)}$, low gate charge. It can be used in a wide variety of applications.</p> <p>General Features</p> <ul style="list-style-type: none"> ● V_{DS} -80V ● I_D (at $V_{GS} = -10V$) -6.5A ● $R_{DS(ON)}$ (at $V_{GS} = -10V$) < 75mΩ ● 100% Avalanche Tested ● RoHS Compliant <p>Application</p> <ul style="list-style-type: none"> ● Power switch ● DC/DC converters 	 <p>Schematic diagram</p>  <p>pin assignment</p>  <p>SOP-8</p>
--	--

Ordering Information

Device	Package	Marking	Packaging
GT700P08S	SOP-8	GT700P08	4000pcs/Reel

Absolute Maximum Ratings $T_C = 25^\circ C$, unless otherwise noted

Parameter	Symbol	Value	Unit
Drain-Source Voltage	V_{DS}	-80	V
Continuous Drain Current	I_D	-6.5	A
Pulsed Drain Current (note1)	I_{DM}	-26	A
Gate-Source Voltage	V_{GS}	± 20	V
Power Dissipation	P_D	3	W
Single pulse avalanche energy (note2)	E_{AS}	81	mJ
Operating Junction and Storage Temperature Range	T_J, T_{stg}	-55 To 150	$^\circ C$

Thermal Resistance

Parameter	Symbol	Value	Unit
Thermal Resistance, Junction-to-Ambient	R_{thJA}	41.6	$^\circ C/W$

Specifications $T_J = 25^\circ\text{C}$, unless otherwise noted						
Parameter	Symbol	Test Conditions	Value			Unit
			Min.	Typ.	Max.	
Static Parameters						
Drain-Source Breakdown Voltage	$V_{(BR)DSS}$	$V_{GS} = 0V, I_D = -250\mu A$	-80	--	--	V
Zero Gate Voltage Drain Current	I_{DSS}	$V_{DS} = -80V, V_{GS} = 0V$	--	--	-1	μA
Gate-Source Leakage	I_{GSS}	$V_{GS} = \pm 20V$	--	--	± 100	nA
Gate-Source Threshold Voltage	$V_{GS(th)}$	$V_{DS} = V_{GS}, I_D = -250\mu A$	-2.0	-3.0	-4.0	V
Drain-Source On-Resistance	$R_{DS(on)}$	$V_{GS} = -10V, I_D = -2A$	--	60	75	m Ω
Forward Transconductance	g_{FS}	$V_{DS} = -5V, I_D = -2A$	--	8	--	S
Dynamic Parameters						
Input Capacitance	C_{iss}	$V_{GS} = 0V,$ $V_{DS} = -40V,$ $f = 1.0MHz$	--	1624	--	pF
Output Capacitance	C_{oss}		--	121	--	
Reverse Transfer Capacitance	C_{rss}		--	5	--	
Total Gate Charge	Q_g	$V_{DD} = -40V,$ $I_D = -2A,$ $V_{GS} = -10V$	--	75	--	nC
Gate-Source Charge	Q_{gs}		--	16	--	
Gate-Drain Charge	Q_{gd}		--	19	--	
Turn-on Delay Time	$t_{d(on)}$	$V_{DD} = -40V,$ $I_D = -2A,$ $R_G = 3\Omega$	--	18	--	ns
Turn-on Rise Time	t_r		--	20	--	
Turn-off Delay Time	$t_{d(off)}$		--	55	--	
Turn-off Fall Time	t_f		--	35	--	
Drain-Source Body Diode Characteristics						
Continuous Body Diode Current	I_S	$T_C = 25^\circ\text{C}$	--	--	-6.5	A
Body Diode Voltage	V_{SD}	$T_J = 25^\circ\text{C}, I_{SD} = -2A, V_{GS} = 0V$	--	--	-1.2	V
Reverse Recovery Charge	Q_{rr}	$I_F = -2A, V_{GS} = 0V$ $di/dt = -100A/\mu s$	--	71	--	nC
Reverse Recovery Time	T_{rr}		--	49	--	ns

Notes

1. Repetitive Rating: Pulse width limited by maximum junction temperature
2. EAS condition : $T_J = 25^\circ\text{C}, V_{DD} = -50V, V_{GS} = -10V, L = 0.5mH, R_G = 25\Omega$
3. Identical low side and high side switch with identical R_G

Gate Charge Test Circuit

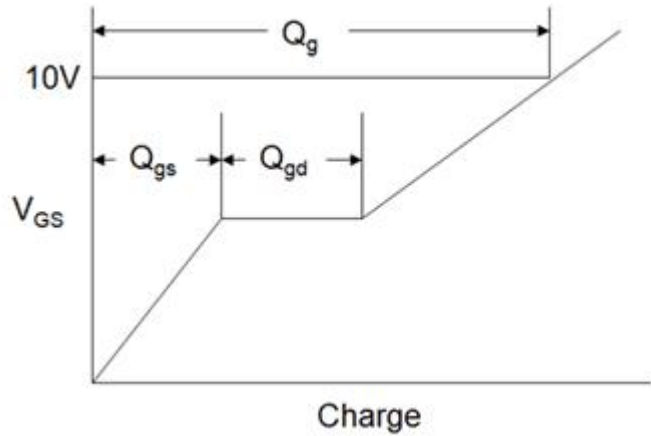

Switch Time Test Circuit

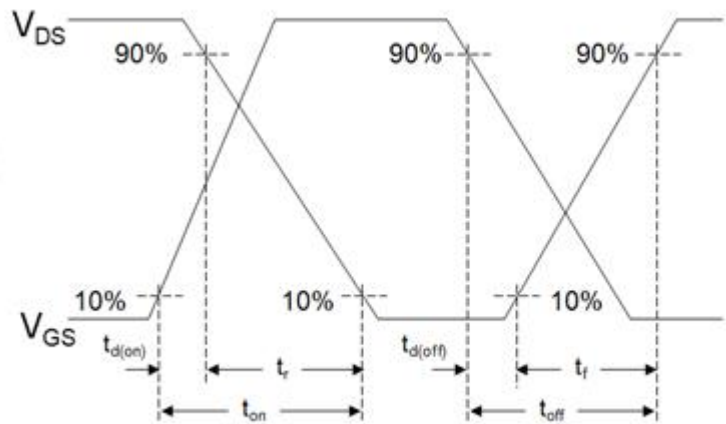
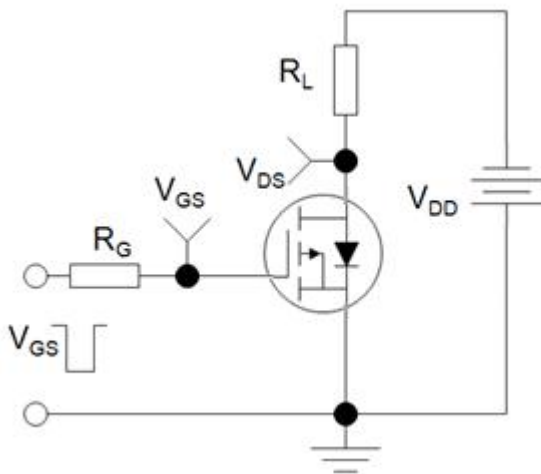

EAS Test Circuit

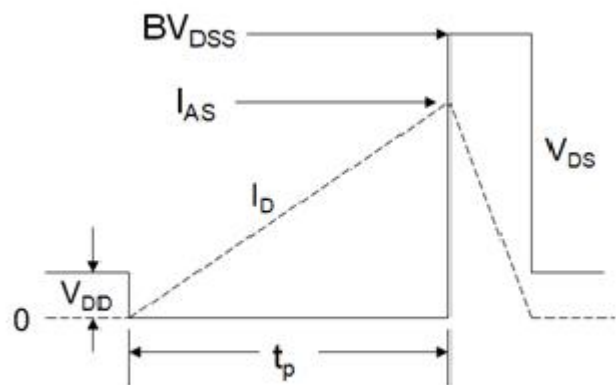

Typical Characteristics $T_J = 25^\circ\text{C}$, unless otherwise noted

Figure 1. Output Characteristics

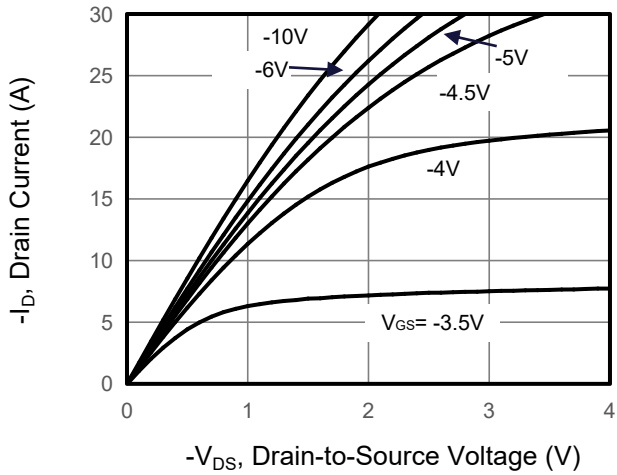

Figure 2. Transfer Characteristics

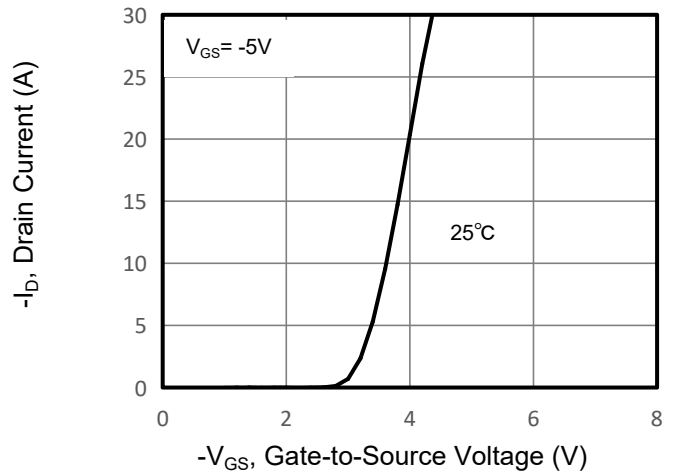

Figure 3. Drain Source On Resistance

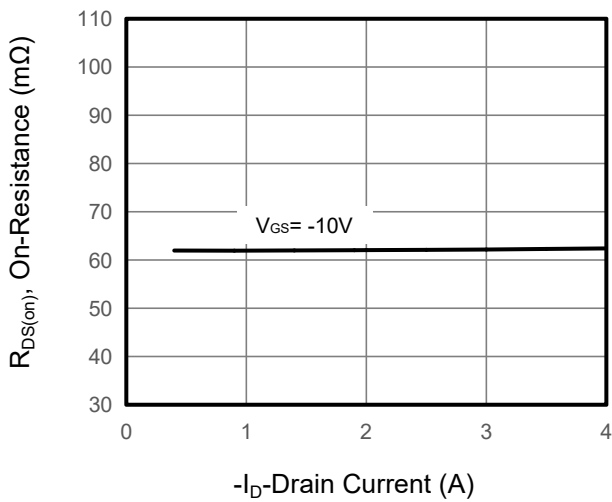

Figure 4. Gate Charge

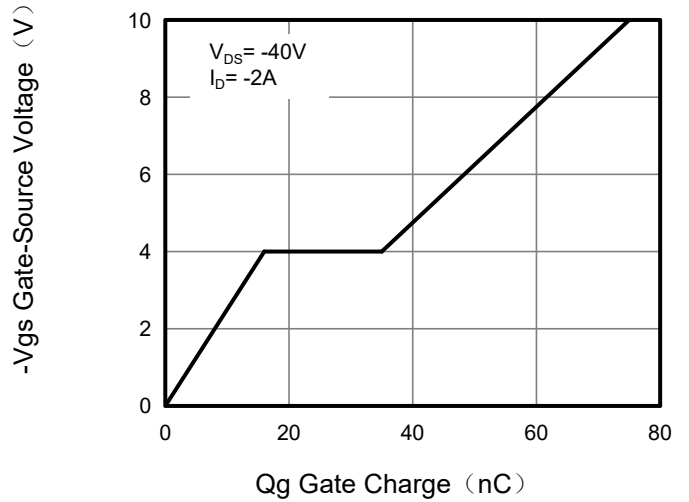

Figure 5. Capacitance

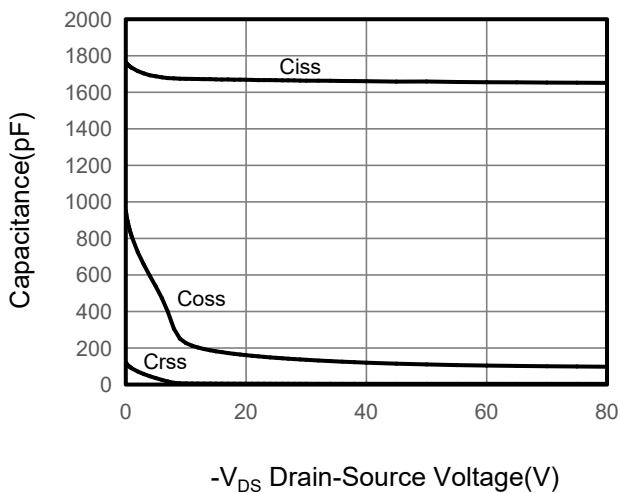
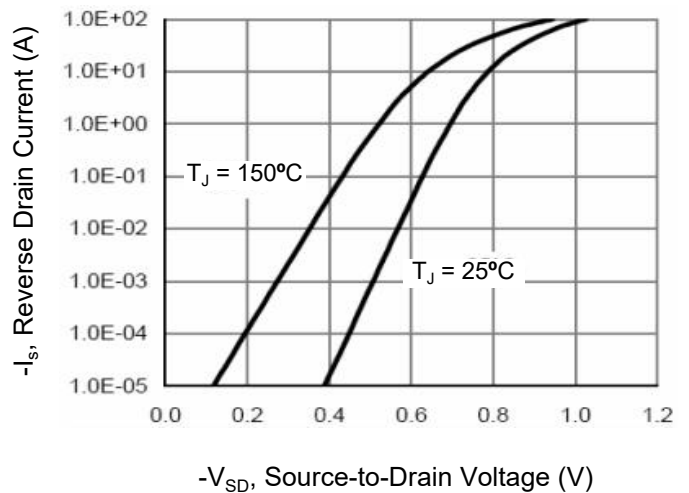

Figure 6. Source-Drain Diode Forward



Typical Characteristics $T_J = 25^\circ\text{C}$, unless otherwise noted

Figure 7. Drain-Source On-Resistance

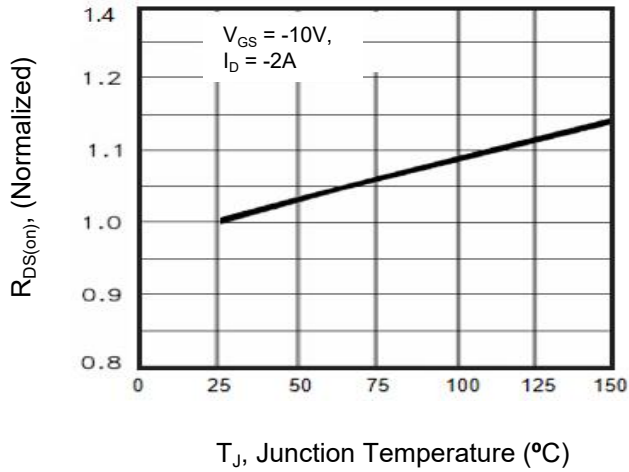

Figure 10. Safe Operation Area

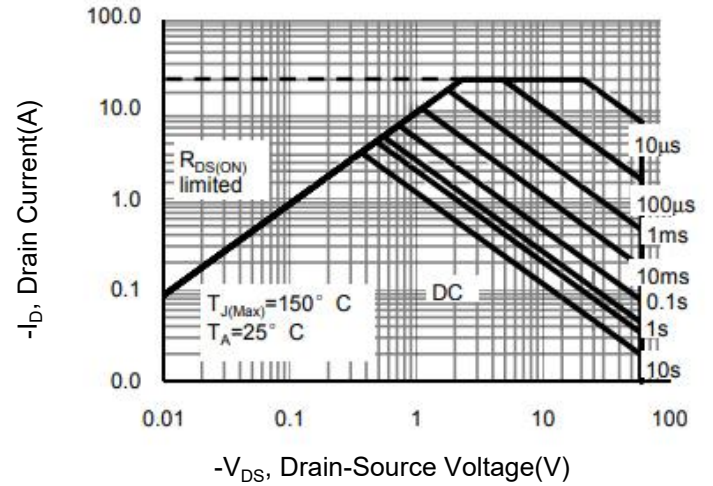
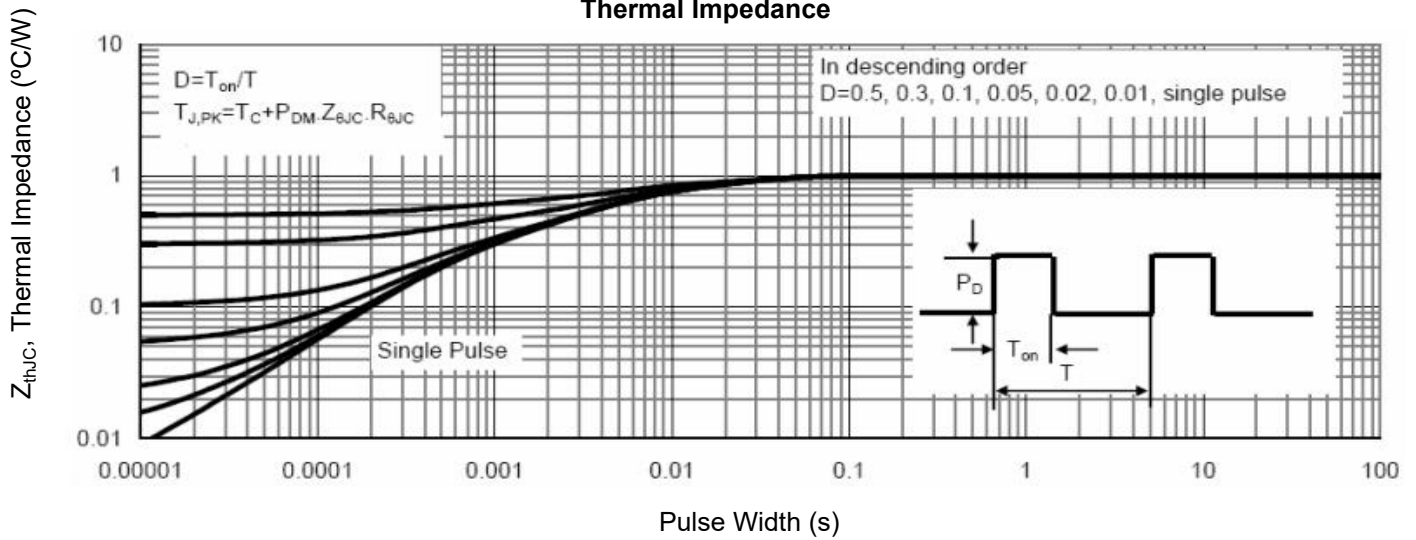
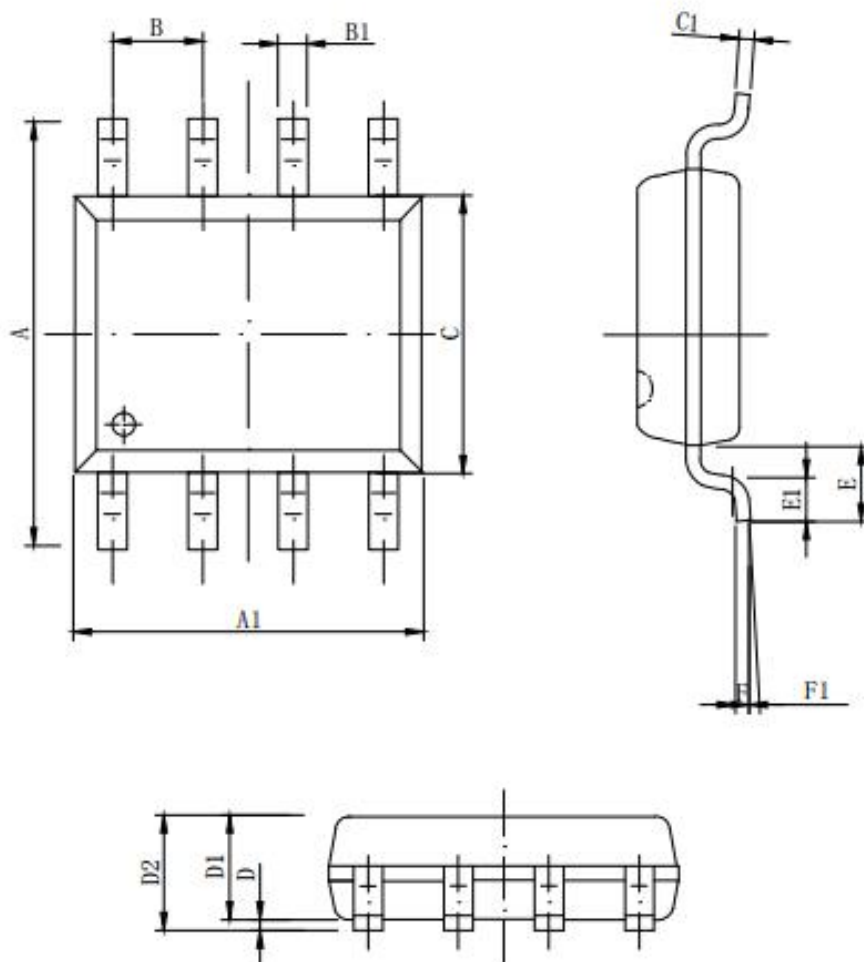

Figure 9. Normalized Maximum Transient Thermal Impedance



SOP-8 Package information



DIM	MIN	NOM	MAX
A	5.800	6.000	6.200
A1	4.800	4.900	5.000
B	1.270BSC		
B1	0.35 [^] 8x	0.40 [^] 8x	0.45 [^] 8x
C	3.780	3.880	3.980
C1	-	0.203	0.253
D	0.050	0.150	0.250
D1	1.350	1.450	1.550
D2	1.500	1.600	1.700
E	1.060 REF		
E1	0.400	0.700	0.100
F	0.250BSC		
F1	2°	4°	6°