

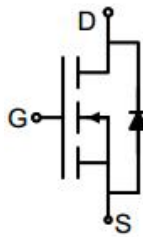

N-Channel Enhancement Mode Power MOSFET

<p>Description</p> <p>The GT105N10K uses advanced trench technology to provide excellent $R_{DS(ON)}$, low gate charge. It can be used in a wide variety of applications.</p> <p>General Features</p> <ul style="list-style-type: none"> ● V_{DS} 100V ● I_D (at $V_{GS} = 10V$) 60A ● $R_{DS(ON)}$ (at $V_{GS} = 10V$) < 10.5mΩ ● 100% Avalanche Tested ● RoHS Compliant <p>Application</p> <ul style="list-style-type: none"> ● Power switch ● DC/DC converters 	 <p>Schematic diagram</p>  <p>TO-252</p>
--	--

Ordering Information

Device	Package	Marking	Packaging
GT105N10K	TO-252	GT105N10	2500psc/Reel

Absolute Maximum Ratings $T_C = 25^\circ C$, unless otherwise noted

Parameter	Symbol	Value	Unit
Drain-Source Voltage	V_{DS}	100	V
Continuous Drain Current	I_D	60	A
Pulsed Drain Current (note1)	I_{DM}	240	A
Gate-Source Voltage	V_{GS}	± 20	V
Power Dissipation	P_D	83	W
Single pulse avalanche energy (note2)	E_{AS}	72	mJ
Operating Junction and Storage Temperature Range	T_J, T_{stg}	-55 To 150	$^\circ C$

Thermal Resistance

Parameter	Symbol	Value	Unit
Thermal Resistance, Junction-to-Ambient	R_{thJA}	42	$^\circ C/W$
Maximum Junction-to-Case	R_{thJC}	1.5	$^\circ C/W$

Specifications $T_J = 25^\circ\text{C}$, unless otherwise noted						
Parameter	Symbol	Test Conditions	Value			Unit
			Min.	Typ.	Max.	
Static Parameters						
Drain-Source Breakdown Voltage	$V_{(BR)DSS}$	$V_{GS} = 0V, I_D = 250\mu A$	100	--	--	V
Zero Gate Voltage Drain Current	I_{DSS}	$V_{DS} = 100V, V_{GS} = 0V$	--	--	1	μA
Gate-Source Leakage	I_{GSS}	$V_{GS} = \pm 20V$	--	--	± 100	nA
Gate-Source Threshold Voltage	$V_{GS(th)}$	$V_{DS} = V_{GS}, I_D = 250\mu A$	2.5	2.9	4	V
Drain-Source On-Resistance	$R_{DS(on)}$	$V_{GS} = 10V, I_D = 35A$	--	8.5	10.5	m Ω
Forward Transconductance	g_{FS}	$V_{GS} = 5V, I_D = 35A$	--	52	--	S
Dynamic Parameters						
Input Capacitance	C_{iss}	$V_{GS} = 0V,$ $V_{DS} = 50V,$ $f = 1.0MHz$	--	1574	--	pF
Output Capacitance	C_{oss}		--	644	--	
Reverse Transfer Capacitance	C_{rss}		--	7	--	
Total Gate Charge	Q_g	$V_{DD} = 50V,$ $I_D = 35A,$ $V_{GS} = 10V$	--	16	--	nC
Gate-Source Charge	Q_{gs}		--	5	--	
Gate-Drain Charge	Q_{gd}		--	3	--	
Turn-on Delay Time	$t_{d(on)}$	$V_{DD} = 50V,$ $I_D = 35A,$ $R_G = 3\Omega$	--	7.5	--	ns
Turn-on Rise Time	t_r		--	2.5	--	
Turn-off Delay Time	$t_{d(off)}$		--	16.4	--	
Turn-off Fall Time	t_f		--	3	--	
Drain-Source Body Diode Characteristics						
Continuous Body Diode Current	I_S	$T_C = 25^\circ\text{C}$	--	--	60	A
Body Diode Voltage	V_{SD}	$T_J = 25^\circ\text{C}, I_{SD} = 35A, V_{GS} = 0V$	--	--	1.2	V
Reverse Recovery Charge	Q_{rr}	$I_F = 35A, V_{GS} = 0V$ $di/dt = 500A/us$	--	132	--	nC
Reverse Recovery Time	T_{rr}		--	30	--	ns

Notes

1. Repetitive Rating: Pulse width limited by maximum junction temperature
2. EAS condition : $T_J = 25^\circ\text{C}, V_{DD} = 50V, V_{GS} = 10V, L = 0.5mH, R_G = 25\Omega$
3. Identical low side and high side switch with identical R_G

Gate Charge Test Circuit



Switch Time Test Circuit



EAS Test Circuit



Typical Characteristics $T_J = 25^\circ\text{C}$, unless otherwise noted

Figure 1. Output Characteristics

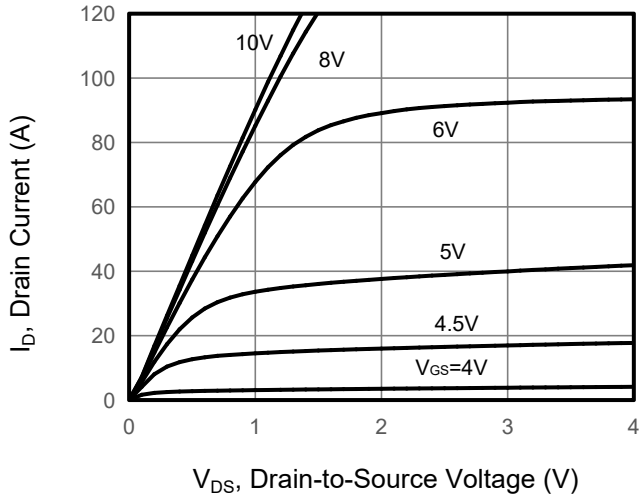

Figure 2. Transfer Characteristics

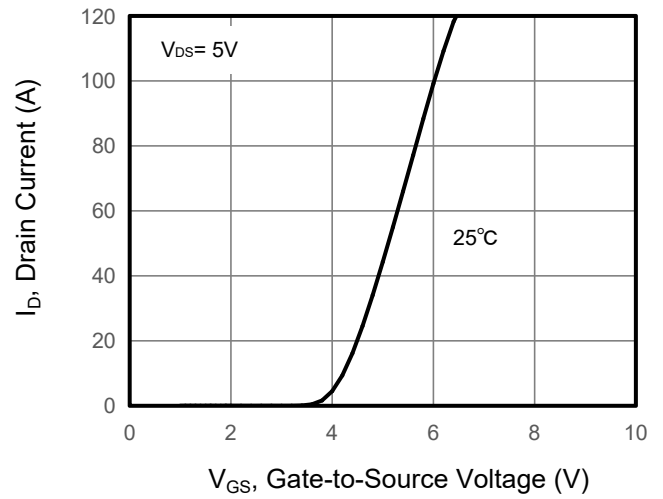

Figure 3. Drain Source On Resistance

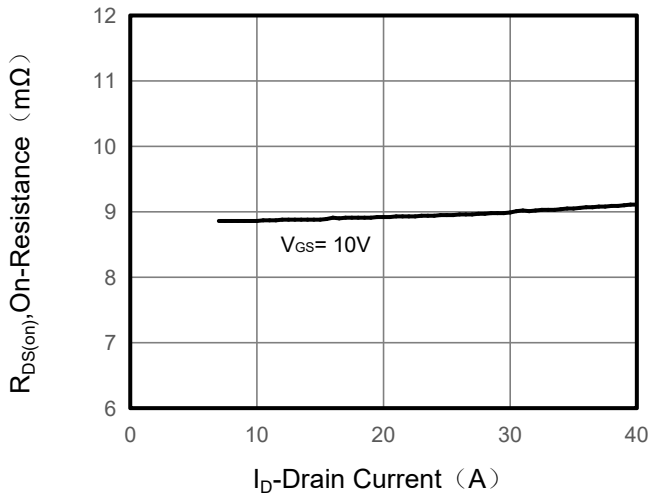

Figure 4. Gate Charge

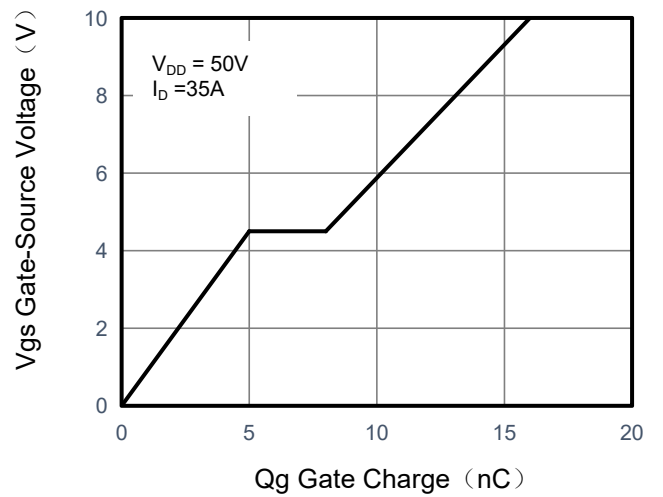

Figure 5. Capacitance

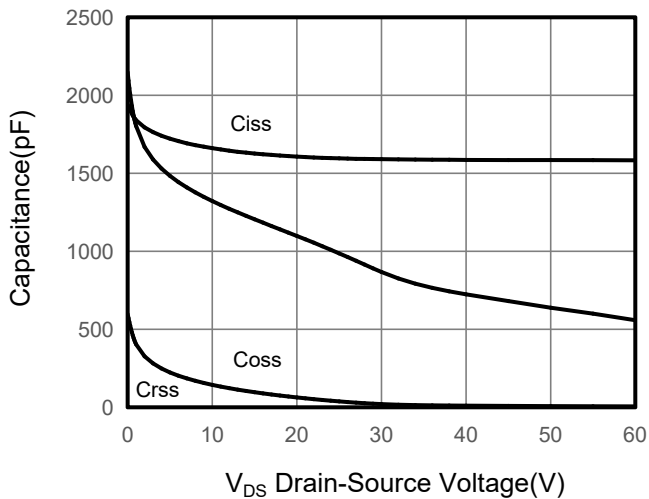
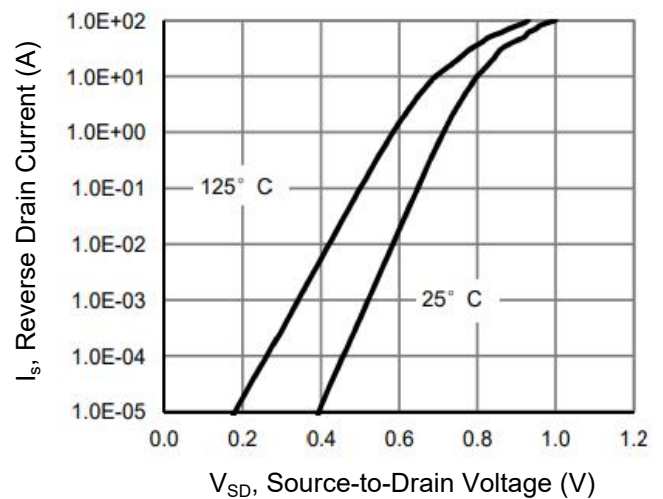

Figure 6. Source-Drain Diode Forward



Typical Characteristics $T_J = 25^\circ\text{C}$, unless otherwise noted

Figure 7. Drain-Source On-Resistance

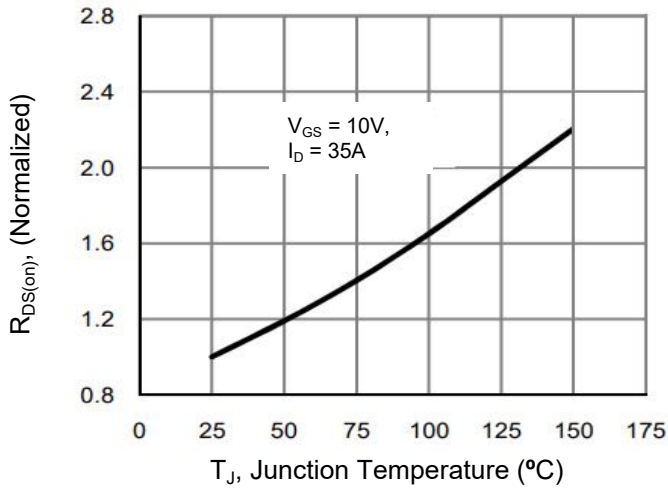

Figure 8. Safe Operation Area

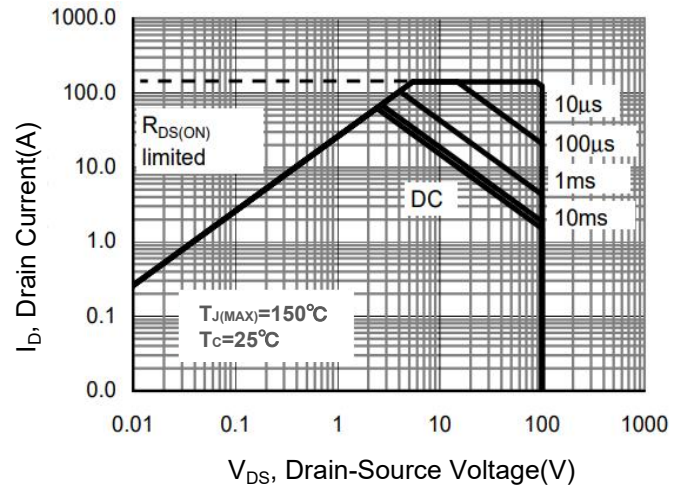
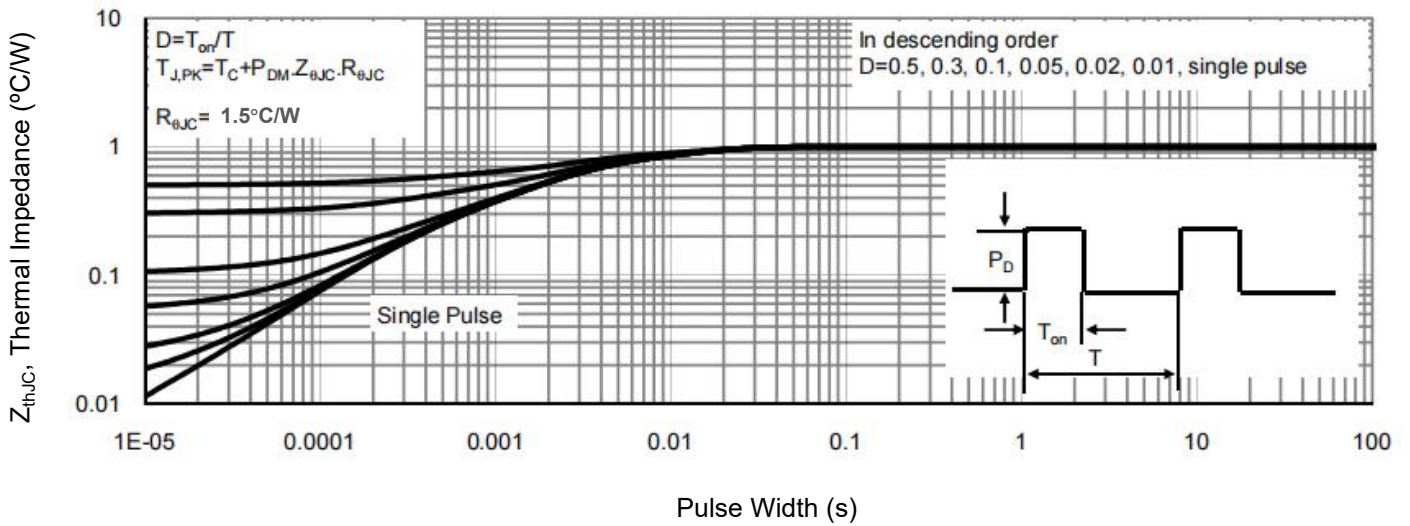
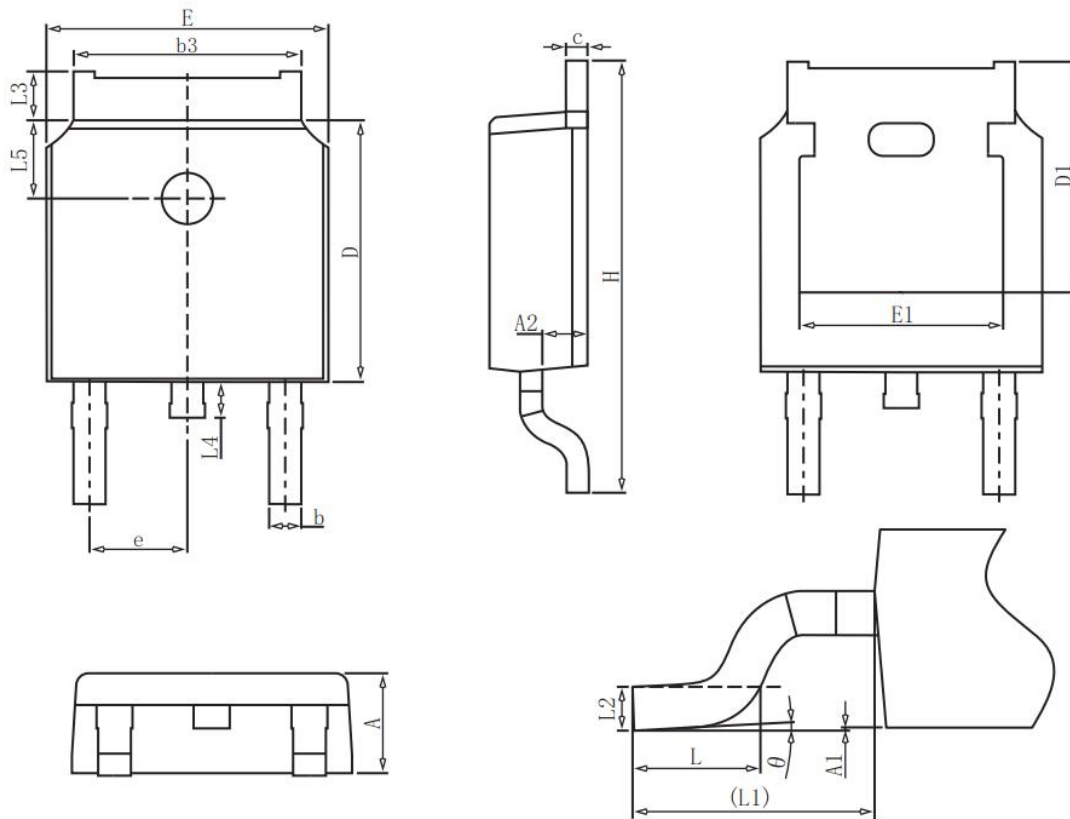

Figure 9. Normalized Maximum Transient Thermal Impedance



TO-252 Package Information



Symbol	Dimensions in Millimeters		
	MIN.	NOM.	MAX.
A	2.2	2.3	2.4
A1	0		0.2
A2	0.97	1.07	1.17
b	0.68	0.78	0.9
b3	5.2	5.33	5.5
c	0.43	0.53	0.63
D	5.98	6.1	6.22
D1	5.30REF		
E	6.4	6.6	6.8
E1	4.63		
e	2.286BSC		
H	9.4	10.1	10.5
L	1.38	1.5	1.75
L1	2.90REF		
L2	0.51BSC		
L3	0.88		1.28
L4	0.5		1
L5	1.65	1.8	1.95
θ	0°		8°