

## N-Channel Enhancement Mode Power MOSFET

### Description

The G030N06M uses advanced trench technology to provide excellent  $R_{DS(ON)}$ , low gate charge. It can be used in a wide variety of applications.

### General Features

- $V_{DS}$  60V
- $I_D$  (at  $V_{GS} = 10V$ ) 223A
- $R_{DS(ON)}$  (at  $V_{GS} = 10V$ ) < 3m $\Omega$
- $R_{DS(ON)}$  (at  $V_{GS} = 4.5V$ ) < 3.8m $\Omega$
- 100% Avalanche Tested
- RoHS Compliant

### Application

- Power switch
- DC/DC converters

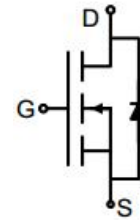

Schematic diagram

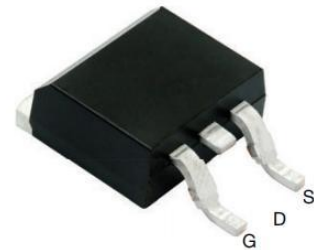

TO-263

### Ordering Information

Device	Package	Marking	Packaging
G030N06M	TO-263	G030N06	800pcs/Reel

### Absolute Maximum Ratings $T_C = 25^\circ C$ , unless otherwise noted

Parameter	Symbol	Value	Unit
Drain-Source Voltage	$V_{DS}$	60	V
Continuous Drain Current	$I_D$	223	A
Pulsed Drain Current (note1)	$I_{DM}$	892	A
Gate-Source Voltage	$V_{GS}$	$\pm 20$	V
Power Dissipation	$P_D$	240	W
Single pulse avalanche energy (note2)	$E_{AS}$	441	mJ
Operating Junction and Storage Temperature Range	$T_J, T_{stg}$	-55 To 150	$^\circ C$

### Thermal Resistance

Parameter	Symbol	Value	Unit
Thermal Resistance, Junction-to-Ambient	$R_{thJA}$	45	$^\circ C/W$
Maximum Junction-to-Case	$R_{thJC}$	0.52	$^\circ C/W$

Specifications $T_J = 25^\circ\text{C}$ , unless otherwise noted						
Parameter	Symbol	Test Conditions	Value			Unit
			Min.	Typ.	Max.	
<b>Static Parameters</b>						
Drain-Source Breakdown Voltage	$V_{(BR)DSS}$	$V_{GS} = 0V, I_D = 250\mu A$	60	--	--	V
Zero Gate Voltage Drain Current	$I_{DSS}$	$V_{DS} = 60V, V_{GS} = 0V$	--	--	1	$\mu A$
Gate-Source Leakage	$I_{GSS}$	$V_{GS} = \pm 20V$	--	--	$\pm 100$	nA
Gate-Source Threshold Voltage	$V_{GS(th)}$	$V_{DS} = V_{GS}, I_D = 250\mu A$	1.0	1.7	2.5	V
Drain-Source On-Resistance	$R_{DS(on)}$	$V_{GS} = 10V, I_D = 30A$	--	2.4	3.0	m $\Omega$
		$V_{GS} = 4.5V, I_D = 30A$	--	3.0	3.8	
Forward Transconductance	$g_{FS}$	$V_{GS} = 5V, I_D = 30A$	--	71	--	S
<b>Dynamic Parameters</b>						
Input Capacitance	$C_{iss}$	$V_{GS} = 0V,$ $V_{DS} = 30V,$ $f = 1.0\text{MHz}$	--	12432	--	pF
Output Capacitance	$C_{oss}$		--	819	--	
Reverse Transfer Capacitance	$C_{rss}$		--	752	--	
Total Gate Charge	$Q_g$	$V_{DD} = 30V,$ $I_D = 30A,$ $V_{GS} = 4.5V$	--	101	--	nC
Gate-Source Charge	$Q_{gs}$		--	34	--	
Gate-Drain Charge	$Q_{gd}$		--	57	--	
Turn-on Delay Time	$t_{d(on)}$	$V_{DD} = 30V,$ $I_D = 30A,$ $R_G = 2.1\Omega$	--	73	--	ns
Turn-on Rise Time	$t_r$		--	244	--	
Turn-off Delay Time	$t_{d(off)}$		--	122	--	
Turn-off Fall Time	$t_f$		--	122	--	
<b>Drain-Source Body Diode Characteristics</b>						
Continuous Body Diode Current	$I_S$	$T_C = 25^\circ\text{C}$	--	--	223	A
Body Diode Voltage	$V_{SD}$	$T_J = 25^\circ\text{C}, I_{SD} = 30A, V_{GS} = 0V$	--	--	1.2	V
Reverse Recovery Charge	$Q_{rr}$	$I_F = 30A, V_{GS} = 0V$ $di/dt=100A/us$	--	344	--	nC
Reverse Recovery Time	$T_{rr}$		--	69	--	ns

## Notes

1. Repetitive Rating: Pulse width limited by maximum junction temperature
2. EAS condition :  $T_J=25^\circ\text{C}$  ,  $V_{DD}=50V, V_{GS}=10V, L=0.5\text{mH}, R_G=25\Omega$
3. Identical low side and high side switch with identical  $R_G$

### Gate Charge Test Circuit



### Switch Time Test Circuit

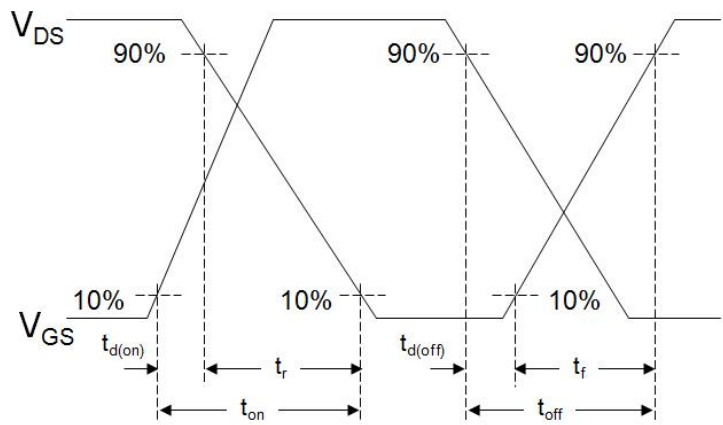

### EAS Test Circuit



Typical Characteristics  $T_J = 25^\circ\text{C}$ , unless otherwise noted

Figure 1. Output Characteristics

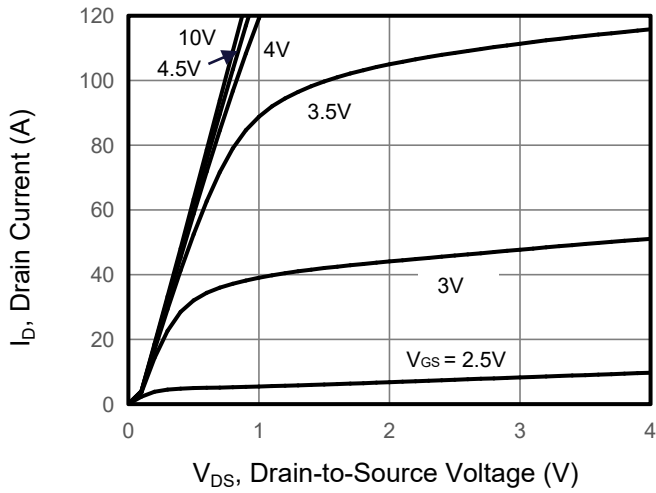

Figure 2. Transfer Characteristics

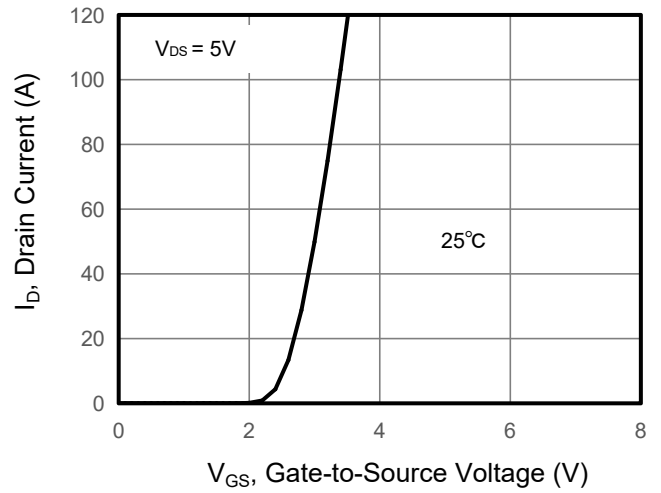

Figure 3. Drain Source On Resistance

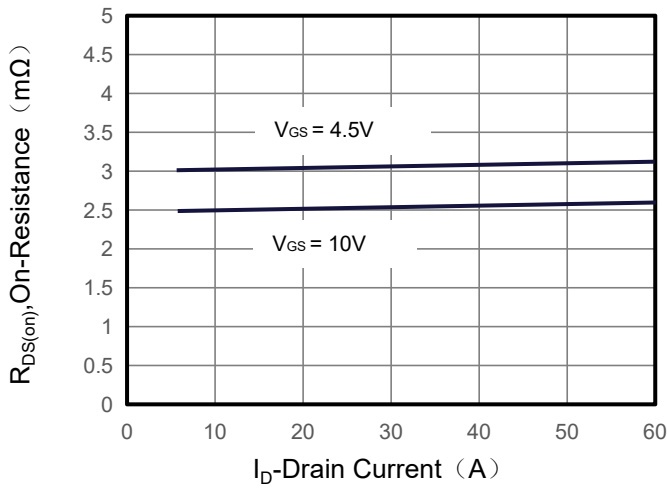

Figure 4. Gate Charge

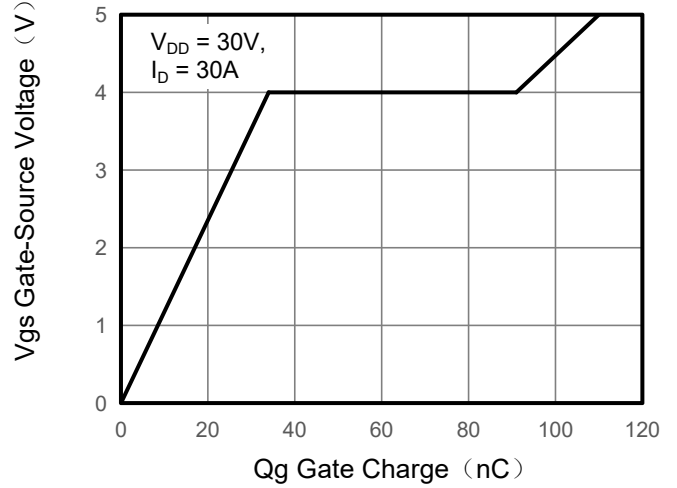

Figure 5. Capacitance

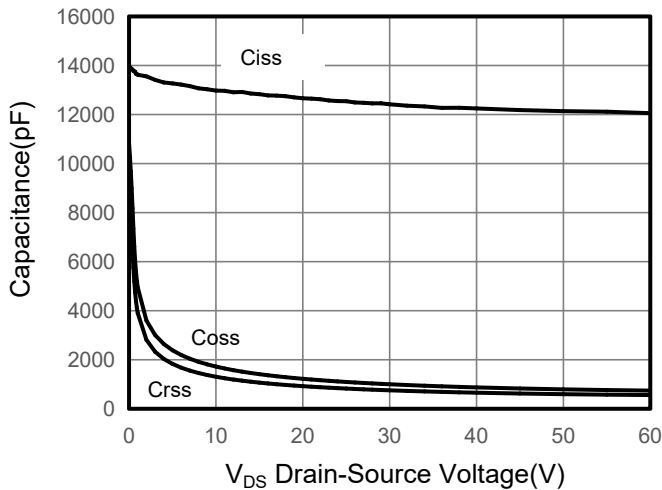
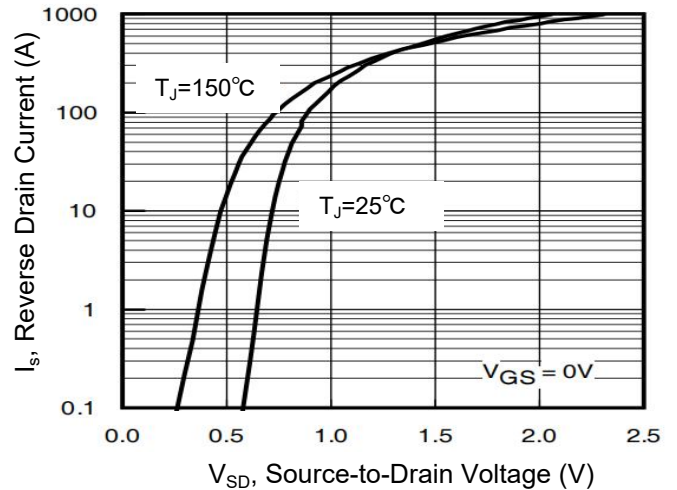
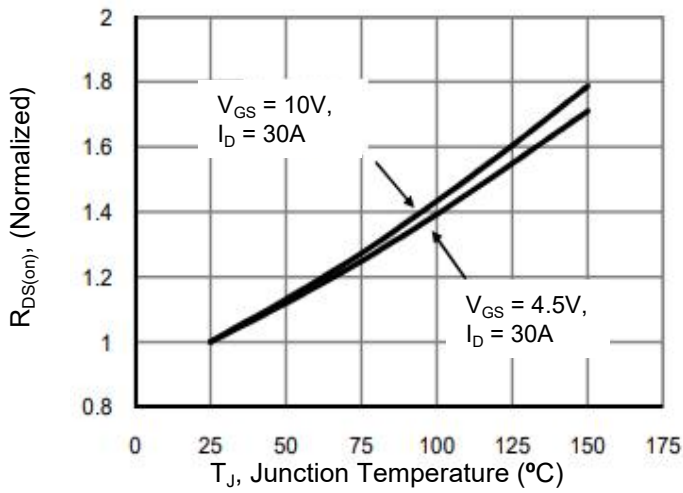

Figure 6. Source-Drain Diode Forward



## Typical Characteristics $T_J = 25^\circ\text{C}$ , unless otherwise noted

**Figure 7. Drain-Source On-Resistance**



**Figure 8. Safe Operation Area**

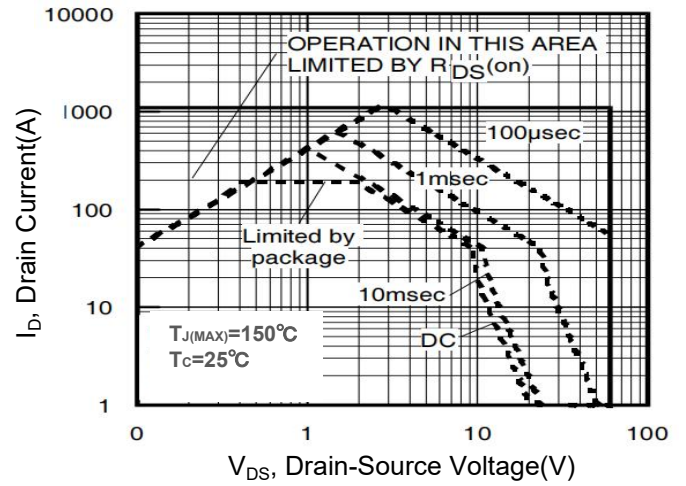

**Figure 9. Normalized Maximum Transient Thermal Impedance**

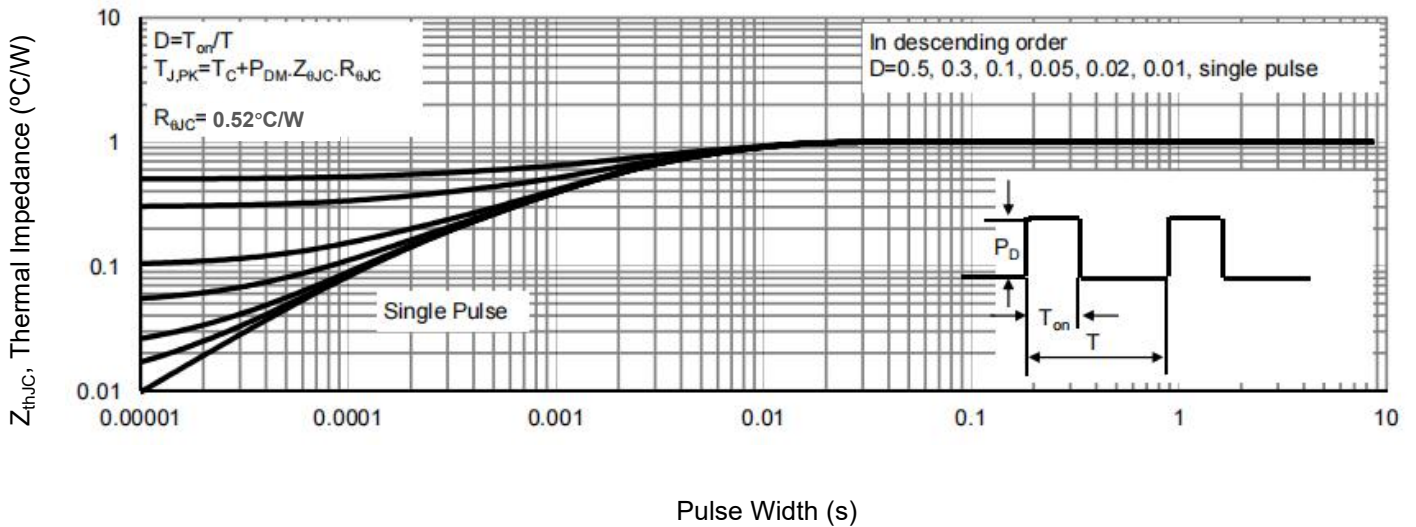

## TO-263 Package Information

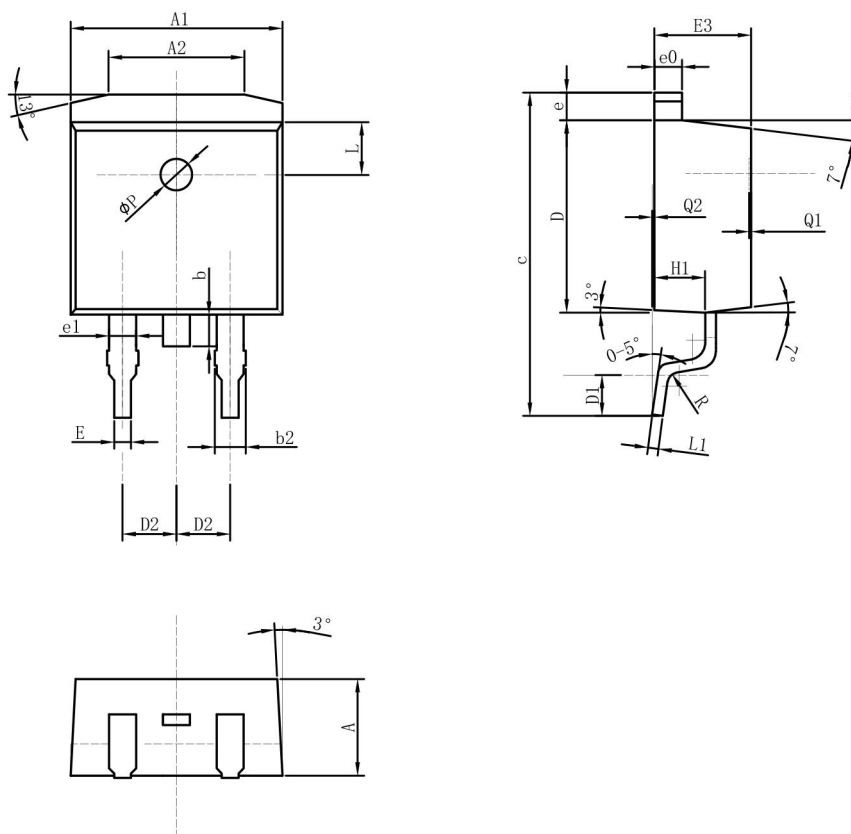

### COMMON DIMENSIONS

SYMBOL	mm		
	MIN	NOM	MAX
A	4.52	4.57	4.62
A1	9.95	10.00	10.05
A2	6.30	6.40	6.50
b	1.30	1.50	1.70
b2	1.17	1.27	1.37
c	14.80	15.00	15.20
D	9.05	9.10	9.15
D1	1.90	2.10	2.30
D2	-	2.54	-
E	-	0.80	-
E3	-	4.57	-
e	-	1.30	-
e0	-	1.30	-
e1	1.73	3	-
H1	-	2.40	-
L	-	2.50	-
L1	-	0.50	-
$\phi P$	-	1.50	-
R	-	0.50	-
Q1	0.10	-	0.15
Q2	0	-	0.02