





SPECIFICATIONS

CUSTOMER : _____
MODEL NO. : **GFT043IC480272L**
VERSION : **C**
DATE : **2023.03.10**
CERTIFICATION : **ROHS**

Customer Sign	Approved By	Prepared By	Prepared By
			

晶發科技股份有限公司
GI FAR TECHNOLOGY CO.,LTD

新北市樹林區東豐街 81 號

No. 81, Dongfeng St, Shulin District, 238034, New Taipei City, Taiwan, R.O.C.

TEL: +886-2-8684-1188 FAX: +886-2-8684-8532



CONTENTS

1. General description
2. Absolute maximum ratings
3. Optical characteristics
4. Block diagram
5. Interface pin connection
6. Electrical characteristics
7. Timing Characteristics
8. Reliability test items
9. General precaution
10. Outline dimension
11. Package Information

Appendix : Inspection Standard



1. General description

1.1 Introduction

It is a color active matrix TFT (Thin Film Transistor) liquid crystal display (LCD) that uses the amorphous silicon TFT as a switching devices. This model is composed of a Transmissive type TFT-LCD Panel, a driver circuit and a back-light unit.

1.2 Features

- High image quality a-Si TFT LCD module.
- 16.7M color number.
- Support 24-bit parallel (RGB) input mode
- High contrast, high brightness
- Low power consumption.

1.3 General information

Item	Specification	Unit
Type	Transmissive	
Display Mode	Normally White	
Pixel Element	a-Si TFT	
Screen Size	4.3inch	
Resolution	480(RGB) x 272	
Active Area	95.04 (W) x 53.856(L) (mm)	
Pixel Size	0.198 x 0.198 (mm)	
Color Arrangement	RGB-stripe	
Assembly Type	COG	
Back Light	LED	
Good Viewing Direction	12 o'clock	
Gray Scale Inversion Direction	6 o'clock	
Module Dimension	105.5(W) x 67.2(L) x 2.9(H) (mm)	
Panel Maker	CMI	
Weight	TBD	



2. ABSOLUTE MAXIMUM RATINGS

2.1 Electrical Absolute Rating

2.1.1 TFT LCD Module

Item	Symbol	Min.	Max.	Unit.	Note
Power supply voltage	VDD	-0.3	4.5	V	--
Logic Signal Input Level	Vin	-0.3	4.5	V	

* If the LSI is used above these absolute maximum ratings, it may become permanently damaged. Using the LSI within the following electrical characteristics limit is strongly recommended for normal operation. If these electrical characteristic conditions are also exceeded, the LSI will malfunction and cause poor reliability.

2.1.2 Back-Light Unit

Item	Symbol	MIN.	MAX.	Unit	Note
current	I _{LED}	--	25	mA	

2.2 Environment Absolute Rating

Item	Symbol	Min.	Max.	Unit	Remarks
Operating Temperature	Topa	-20	+70	°C	
Storage Temperature	Tstg	-30	+80	°C	

(1) Corrosive gas environment is not acceptable.

(2) TFT-LCD color will change slightly depending on environment temperature. This phenomenon is reversible.



3. OPTICAL CHARACTERISTICS

Ta=25°C , ILED=20mA

Item	Symbol	Condition	Min.	Typ.	Max.	Unit	Note	
Brightness	B	θ=0° Normal viewing angle At the center of panel	--	600	--	cd/m ²	(1)	
Contrast Ratio	C/R		--	500	--	--	(2)	
Response Time	Tr		--	5	--	ms	(3)	
	Tf		--	15	--			
Color chromatic ity	White		Wx	(0.270)	(0.320)	(0.370)	--	--
			Wy	(0.245)	(0.295)	(0.345)		
	Red		Rx	(0.552)	(0.602)	(0.652)	--	--
			Ry	(0.303)	(0.353)	(0.403)		
	Green		Gx	(0.292)	(0.342)	(0.392)	--	--
			Gy	(0.531)	(0.581)	(0.631)		
	Blue	Bx	(0.094)	(0.144)	(0.194)	--	--	
		By	(0.062)	(0.112)	(0.162)			
Viewing Angle	Top	C/R ≥ 10 Backlight On	60	70	--	Deg.	(4)	
	Bottom		40	50	--			
	Left		60	70	--			
	Right		60	70	--			
Uniformity	Un	θ=0° Normal viewing angle	80	--	--	%	(5)	



Note 1: The brightness test equipment setup

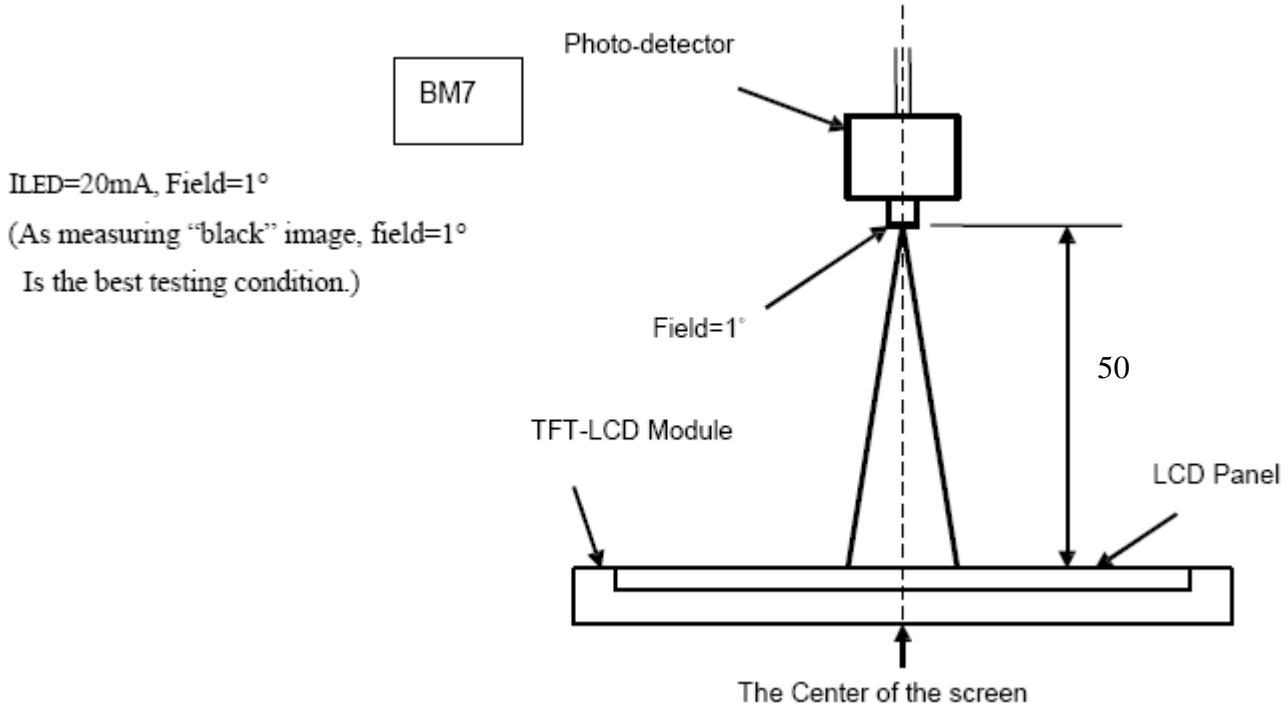

Note 2: Definition of contrast Ratio (C/R)

$$C/R = \frac{\text{Brightness When LCD is at "White" State}}{\text{Brightness When LCD is at "Black" State}}$$

Note 3: Definition of response time

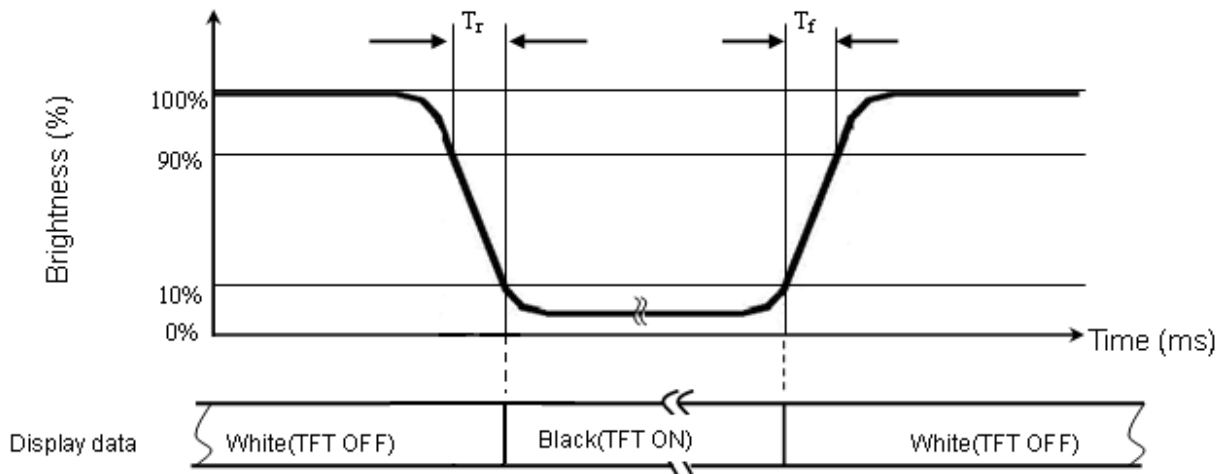



Note 4: Definition of viewing angle

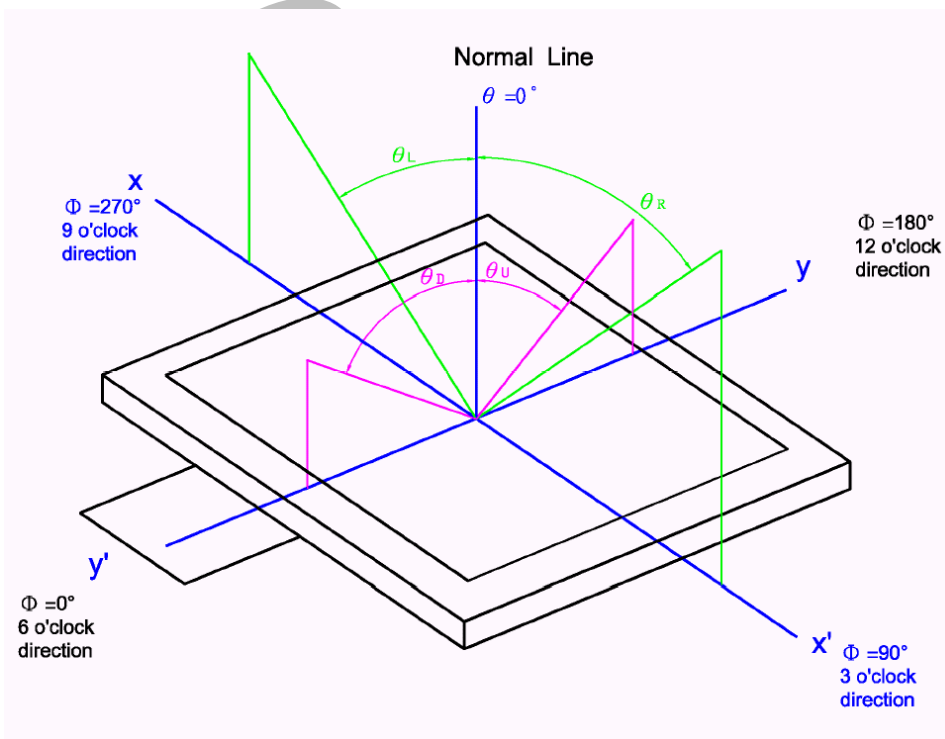

Note 5: Definition of uniformity (U_n)

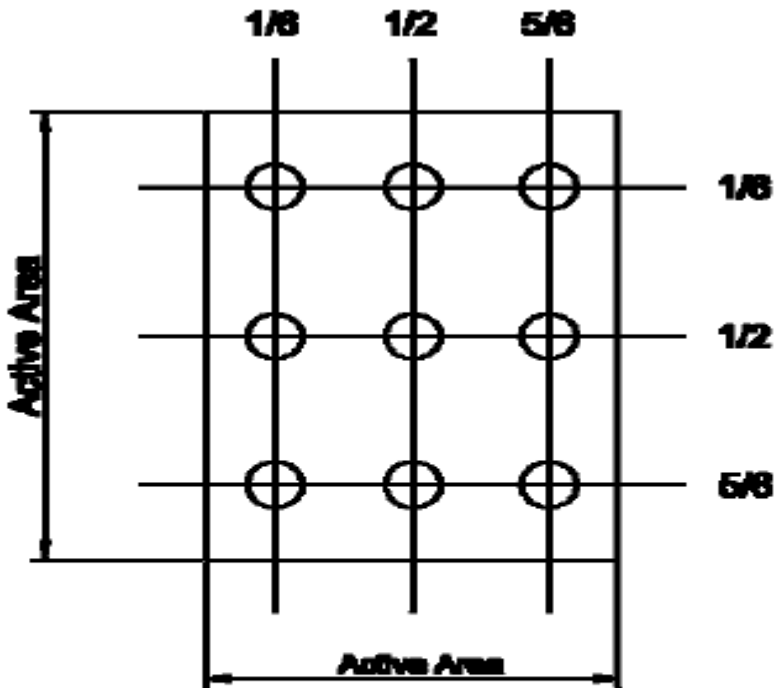

$$U_n = \frac{B_{min}}{B_{max}}$$



4. BLOCK DIAGRAM

4.1 TFT LCD Module

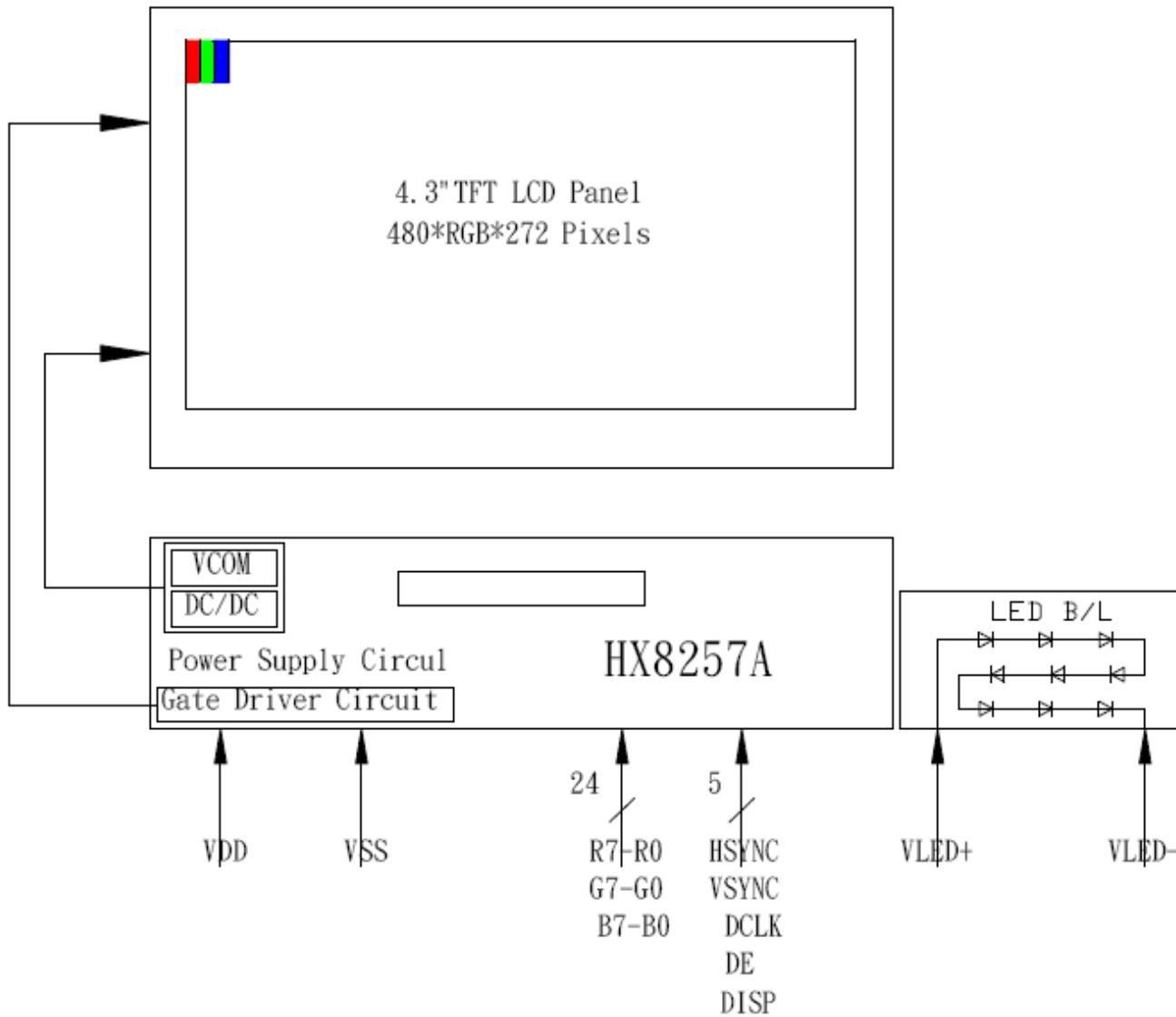

100%



5. INTERFACE PIN CONNECTION

5.1 Input Signal & Power

Terminal	Symbol	IO	Functions
1	LEDK	P	Power for LED backlight cathode
2	LEDA	P	Power for LED backlight anode
3	GND	P	Power Ground
4	VDD	P	Digital Power
5	R0	I	Red data bit 0
6	R1	I	Red data bit 1
7	R2	I	Red data bit 2
8	R3	I	Red data bit 3
9	R4	I	Red data bit 4
10	R5	I	Red data bit 5
11	R6	I	Red data bit 6
12	R7	I	Red data bit 7
13	G0	I	Green data bit 0
14	G1	I	Green data bit 1
15	G2	I	Green data bit 2
16	G3	I	Green data bit 3
17	G4	I	Green data bit 4
18	G5	I	Green data bit 5
19	G6	I	Green data bit 6
20	G7	I	Green data bit 7
21	B0	I	Blue data bit 0
22	B1	I	Blue data bit 1
23	B2	I	Blue data bit 2
24	B3	I	Blue data bit 3
25	B4	I	Blue data bit 4
26	B5	I	Blue data bit 5
27	B6	I	Blue data bit 6
28	B7	I	Blue data bit 7
29	GND	P	Power Ground
30	DCLK	I	Clock signal for data latching and internal counter of the timing controller
31	DISP	I	Display on/off mode control
32	HSYNC	I	Horizontal sync input
33	VSYNC	I	Vertical sync input
34	DE	I	Data Enable
35	NC	--	No Connect
36	GND	P	Power Ground
37	NC	I/O	No Connect
38	NC	I/O	No Connect
39	NC	I/O	No Connect
40	NC	I/O	No Connect



6. ELECTRICAL CHARACTERISTICS

6.1 TFT LCD Module

Item	Symbol	Min.	Typ.	Max.	Unit	Note
Power Supply	VDD	3.1	3.3	3.5	V	
Operating Current	IDD	--	-	25	mA	
High level input voltage	VIH	0.8VDD	--	VDD	V	NOTE(1)
Low level input voltage	VIL	0	--	0.2VDD	V	NOTE(1)

NOTE(1) : CLK , DE , R0~R7 , G0~G7 , B0~B7

6.2 Back-Light Unit

Ta =25°C

Item	Symbol	Min.	Typ.	Max.	Unit	Note
LED current	IL	--	20	--	mA	(1)
LED Voltage	VL	26.1	28.8	32.4	V	
Life Time	Lf	-	20,000	-	Hour	(2)

NOTE (1) : The LEDs is serial type.

NOTE (2) : The "LED life time" is defined as the module brightness decreases to 50% of original brightness that the ambient temperature is 25°C and ILED=20mA . The LED lifetime could be decreased if operating ILED is large than 20mA.

NOTE (3) : Back-light circuit :



NOTE (4) : Current reduction rate of LED backlight is according to the graph indicated below :

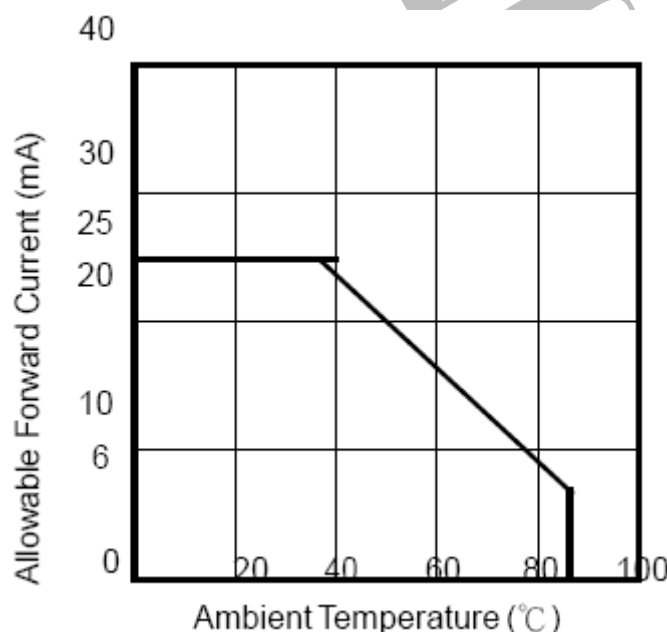



7. Timing Characteristics

7.1 AC Characteristics

The HX8257-A both supports DE mode and Sync mode timing. The mode was decided by DE signal internally. When DE is pulled low, the HX8257-A uses HS+VS for timing control and this timing mode is sync mode. When DE is pulled high for active data and pulled low for blanking data, the HX8257-A uses DE for timing control and this timing mode is DE mode. The detail timing chart showed below.

Clock and Data Input Timing Diagram

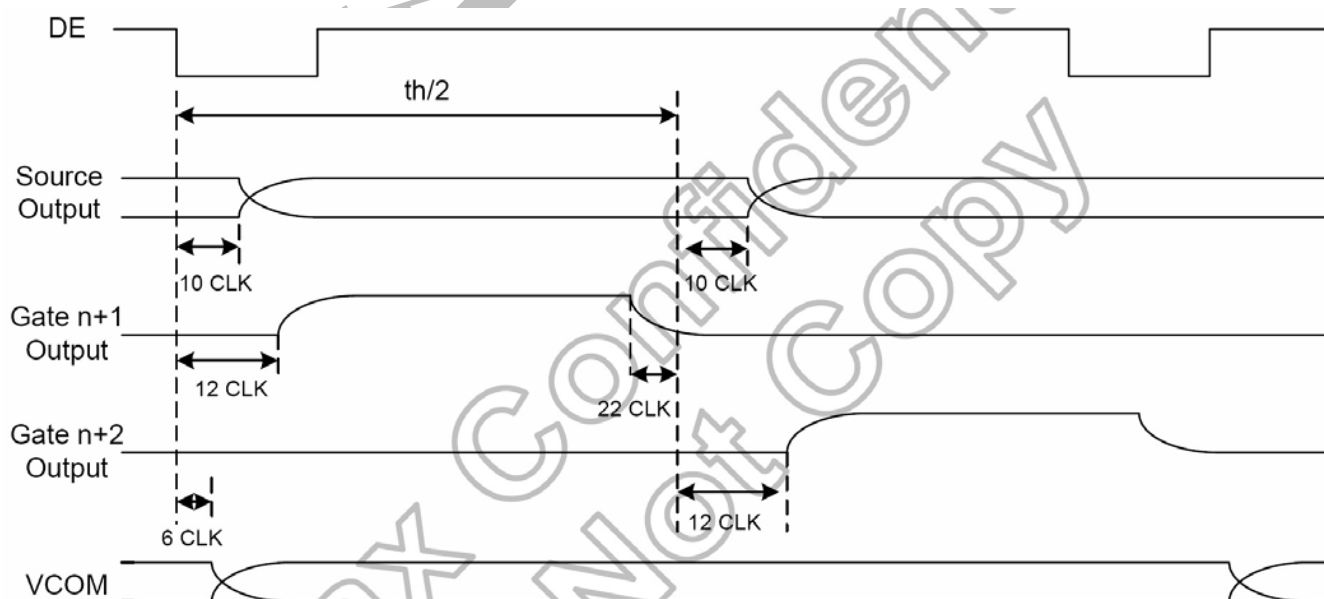

7.2 Timing Conditions Parallel RGB Input Timing Table

Parameter	Symbol	Spec.			Unit
		Min.	Typ.	Max.	
Clock cycle	$f_{CLK}^{(1)}$	-	9	15	MHz
Hsync cycle	$1/th$	-	17.14	-	KHz
Vsync cycle	$1/tv$	-	59.94	-	Hz
Horizontal Signal					
Horizontal cycle	th	525	525	605	CLK
Horizontal display period	thd	480	480	480	CLK
Horizontal front porch	thf	2	2	82	CLK
Horizontal pulse width	$thp^{(2)}$	2	41	41	CLK
Horizontal back porch	$thb^{(2)}$	2	2	41	CLK
Vertical Signal					
Vertical cycle	tv	285	286	399	$H^{(1)}$
Vertical display period	tvd	272	272	272	$H^{(1)}$
Vertical front porch	tvf	1	2	227	$H^{(1)}$
Vertical pulse width	$tvp^{(2)}$	1	10	11	$H^{(1)}$
Vertical back porch	$tvb^{(2)}$	1	2	11	$H^{(1)}$

Note: (1) Unit: $CLK=1/f_{CLK}$, $H=th$,

(2) It is necessary to keep $tvp+tvb=12$ and $thp+thb=43$ in sync mode. DE mode is unnecessary to keep it.



RGB Input Timing Diagram

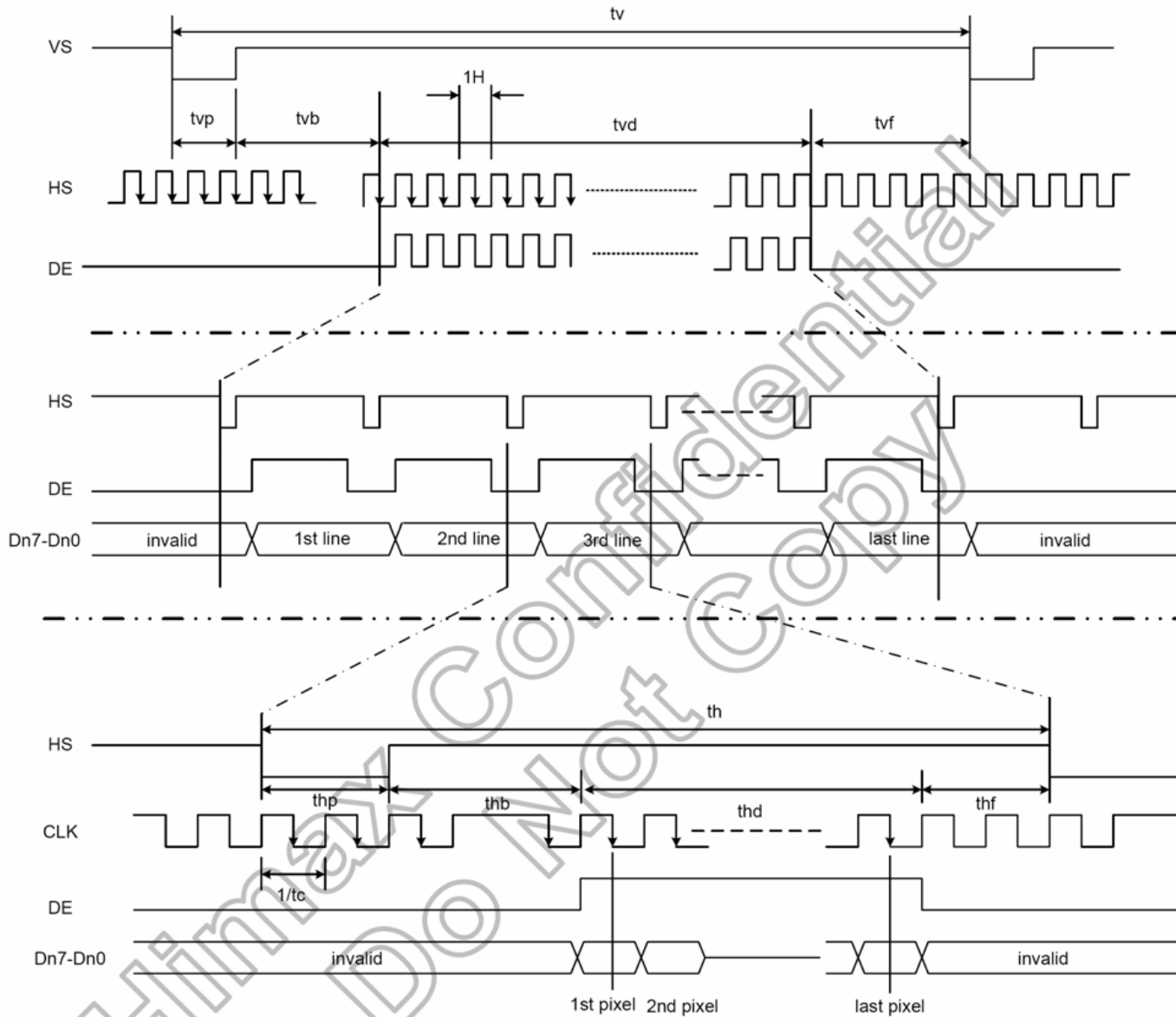



7.3 Power On/Off Sequence

Power On

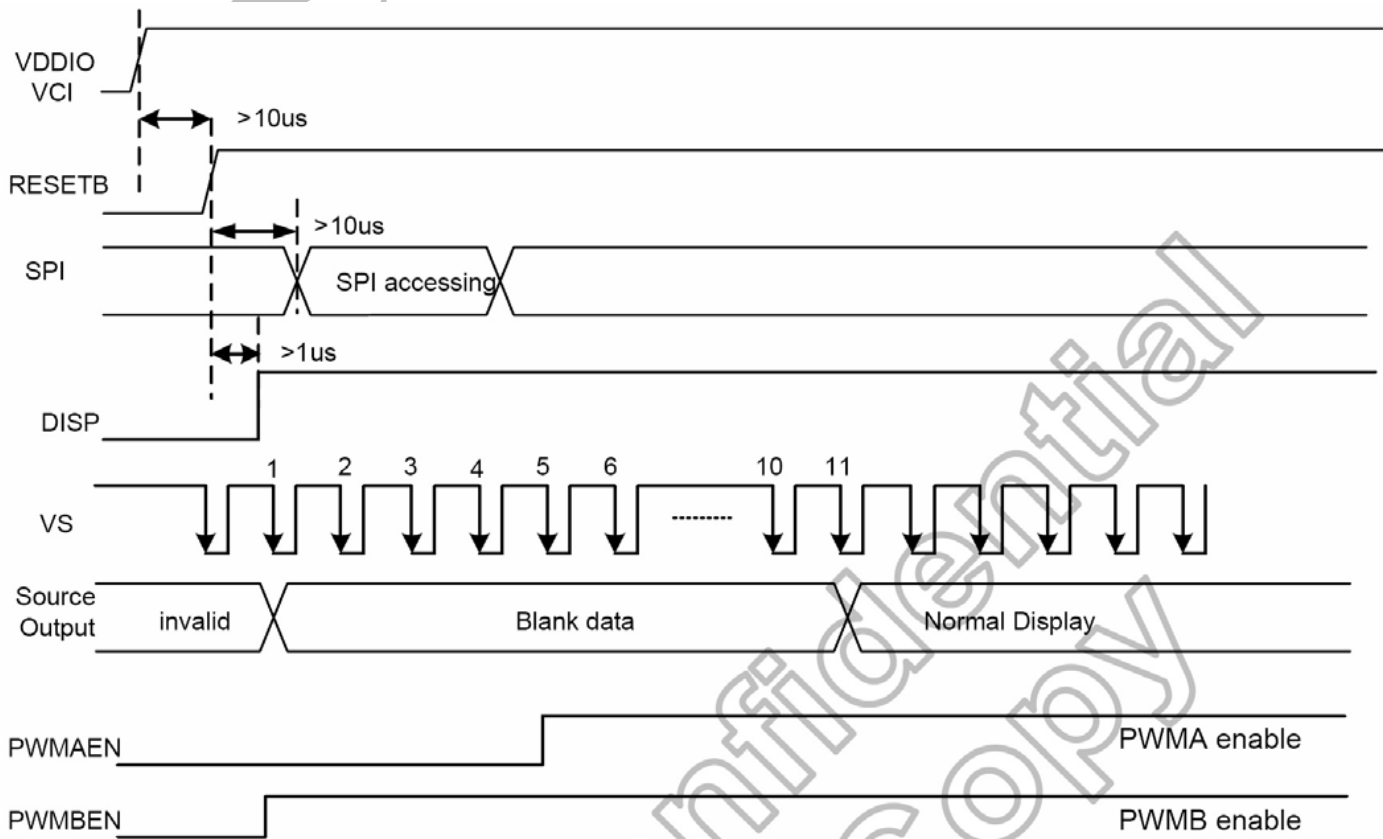

Power Off

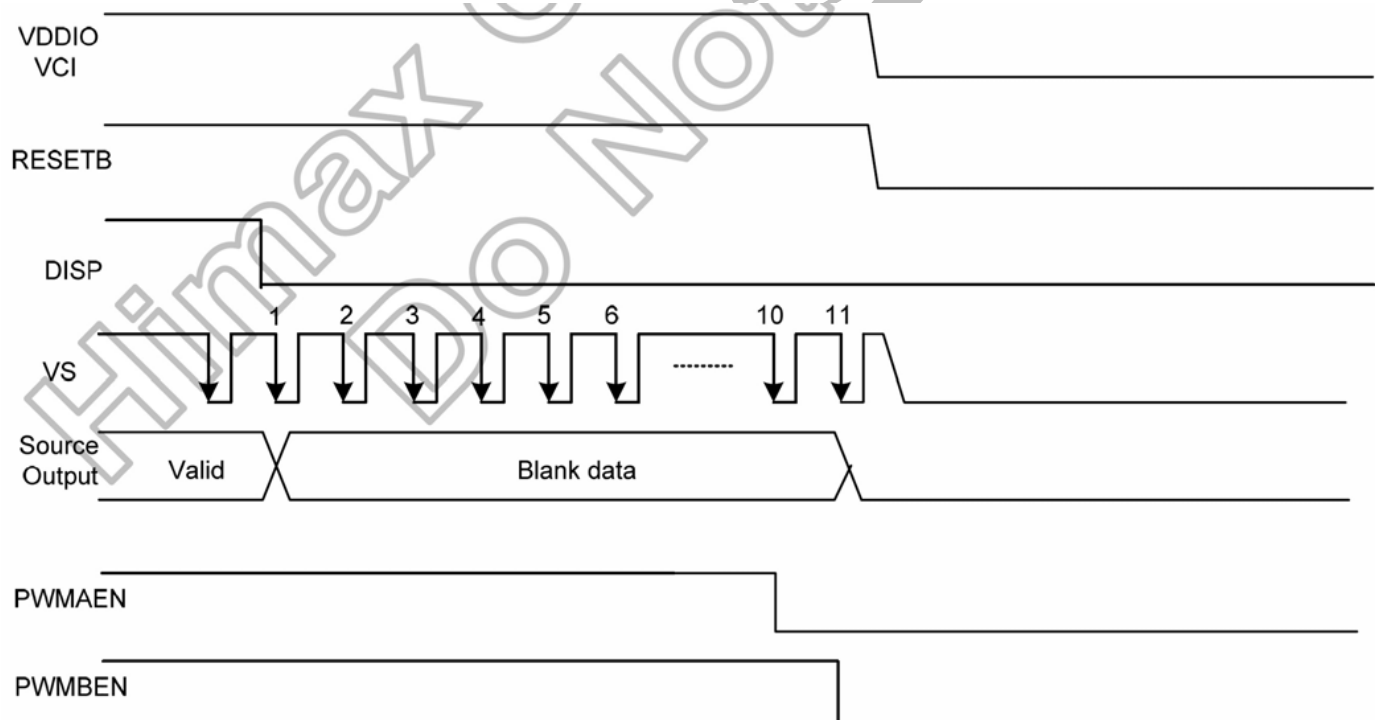



8. Reliability Test Items

Test Item	Test Conditions	Notes
High temperature Operation	70±3°C ,T=120hrs	
Low temperature Operation	-20±3°C ,T=120hrs	
High Temperature Storage	80±3°C ,T=120hrs	
Low Temperature Storage	-30±3°C ,T=120hrs	
Humidity Test	60°C ,Humidity 90% ,120hrs	
Thermal Shock Test	-20°C ,30min~70°C ,30min (100 cycle)	
Vibration Test(Packing)	Freq.:10~55~10~55~10 Hz, Amplitude : 1.5 mm. 2 hours for each direction of X, Y, Z	Non-operation
Static Electricity	±2KV, Human Body Mode, 100pF / 1500Ω	Non-operation
<p>Criterion: There should be no change which might affect the practical display function when the display quality test is conducted under normal operating condition.</p>		



9. General Precautions

Please pay attentions to the followings as using the LCD module.

9.1 Handling

- (a) Do not apply strong mechanical stress like drop, shock or any force to LCD module. It may cause improper operation, even damage.
- (b) Because the polarizer is very fragile and easy to be damaged, do not hit, press or rub the display surface with hard materials.
- (c) Do not put heavy or hard material on the display surface, and do not stack LCD modules.
- (d) If the display surface is dirty, please wipe the surface softly with cotton swab or clean cloth.
- (e) Avoid using Ketone type materials (e.g. Acetone), Toluene, Ethyl acid or Methyl chloride to clean the display surface. It might damage the polarizer permanently. The recommended solvents are water and Isopropyl alcohol.
- (f) Wipe off water droplets or oil immediately.
- (g) Protect the LCD module from ESD. It will damage the LSI and the electronic circuit.
- (h) Do not touch the output pins directly with bare hands.
- (I) Do not disassemble the LCD module.

9.2 Storage

- (a) Do not leave the LCD modules in high temperature, especially in high humidity for a long time.
- (b) Do not expose the LCD modules to sunlight directly.
- (c) The liquid crystal is deteriorated by ultraviolet. Do not leave it in strong ultraviolet ray for a long time.
- (d) Avoid condensation of water. It may cause improper operation.
- (e) Please stack only up to the number stated on carton box for storage and transportation. Excessive weight will cause deformation and damage of carton box.

9.3 Operation

- (a) When mounting or dismounting the LCD modules, turn the power off.
- (b) Protect the LCD modules from electric shock.
- (c) The Driver IC control algorithms should always obeyed to avoid damaging the LSI and electronic circuit.
- (d) Be careful to avoid mixing up the polarity of power supply for backlight.
- (e) Absolute maximum rating specified above has to be always kept in any case. Exceeding it may cause non-recoverable damage of electronic components or, nevertheless, burning.
- (f) When a static image is displayed for a long time, remnant image is likely to occur.
- (g) Be sure to avoid bending the FPC to an acute shape, it might break FPC.

9.4 Others

- (a) If the liquid crystal leaks from the panel, it should be kept away from the eyes or mouth.
- (b) For the fragility of polarizer, it is recommended to attach a transparent protective plate over the display surface.
- (c) It is recommended to peel off the protection film on the polarizer slowly so that the electrostatic charge can be minimized.



11. PACKAGE INFORMATION

1	1 Tray	:	6 pcs (modules)
2	1 stack	:	10 tray +1 Cover tray
3	1 Carton	:	(1 Cover tray + 10 tray) 3 stack
4	Total pcs	:	1 Carton (6pcs * 10tray * 3 stack) = 18 pcs
5	Carton size = NO. 17	:	495*315*435mm
6	Net weight	:	TBD KG
7	Gross weight	:	TBD KG

** Packaging information **

- 1 Tray = 6 pcs

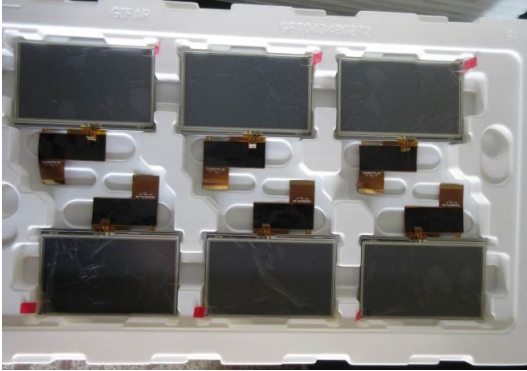

- 1 stack=10 tray+1 Cover tray

**Each layer of tray should be staggered stacked



WW

- 1 Carton = 3 stack, Total pcs = 180 pcs



出貨檢驗標準書
Shipping inspection standard

核准 Approved by	審核 Checked by	作成 Made by
ANDY	JACKY	RUBY

1.目的 Purpose :

規範出貨產品之檢驗項目及判斷標準，確保產品出貨能滿足客戶要求。

Standardize the inspection items and judgment standards to ensure the products that shipped out can meet customer's requirements.

2.範圍 Area :

適用於出廠之所有產品。

Applicable to all products shipped from the factory.

3.名詞解釋 Explanation of terms :

3-1 主要缺陷：亦會造成功能缺失或嚴重外觀缺陷。

Major Defects: It also causes loss of function or serious appearance defects.

3-2 次要缺陷：稍有缺陷但不影響客戶使用。

Minor defect: Slightly defective but does not affect customer use.

4.檢驗體制 Inspection system :

4-1 抽樣計劃：依 ANSI/ASQ Z1.4 一般檢驗水準 II 之 正常檢驗一次抽驗方案。

Sampling plan: According to ANSI/ASQ Z1.4 general inspection level II the normal inspection one-time sampling plan.

4-2 允收水準 Acceptable Level : (AQL)

主要缺陷 Major defect : 0.4 %

次要缺陷 Minor defect : 0.65 %

5.檢驗條件 Inspection conditions :

5-1 使用相關之檢測儀器及測試、量測工具。

Use relevant testing instrument, testing and measuring tools .

5-2 環境要求：其條件需控制在常溫下 $23^{\circ}\text{C}\pm 3^{\circ}\text{C}$ 及溼度 70%RH 以下。

Environmental requirements: The conditions should be controlled at room temperature $23^{\circ}\text{C}\pm 3^{\circ}\text{C}$ and humidity below 70%RH.

5-3 外觀檢驗：須在 $380\pm 20\%$ LUX 的白色日光燈下，其目視距離需於產品離 30 ± 5 cm 檢驗。

Appearance inspection: Under the white fluorescent lamp of $380\pm 20\%$ LUX , the visual distance shall be checked above the product 30 ± 5 cm.

5-4 電性測試 Electrical Testing :

5-4-1 有背光之產品需關燈並在 $5\sim 300\text{Lux}\pm 3\%$ 下檢驗。

The products with backlight should be tested at $5\sim 300\pm 3\%$ Lux.

5-4-2 無背光之產品需開燈並在 $60\sim 300\text{Lux}\pm 3\%$ 白色日光燈下檢驗。

Products without backlight need to be turned on and tested under $60\sim 300 \pm 3\%$ LUX white fluorescent lamps .

5-5 檢查視角依產品視角方向。

Check the viewing angle according to the product viewing angle.

5-6 其不良現象檢視區域 Bad phenomenon View area

5-6-1 適用種類 Applicable category : COB、TFT

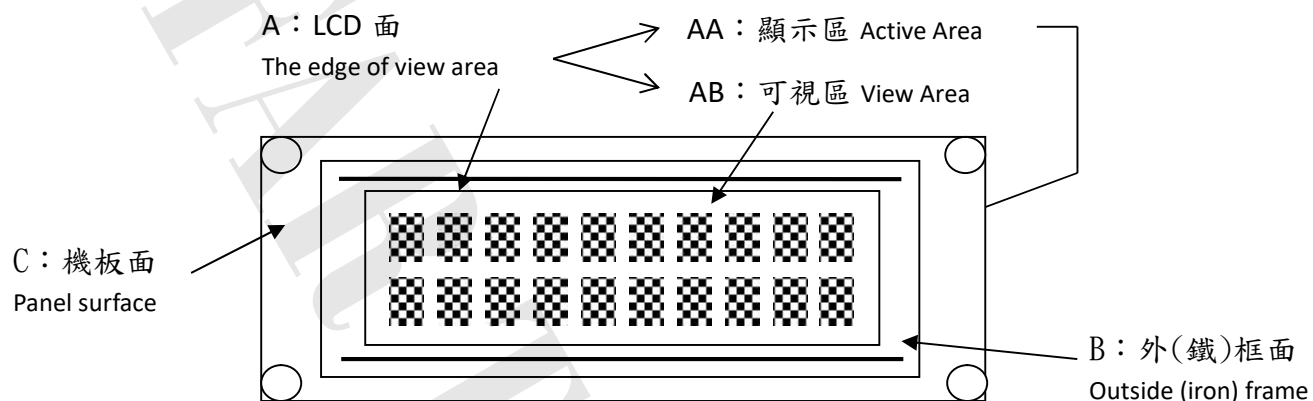

5-6-2 適用種類 Applicable category : COG、TAB、TN

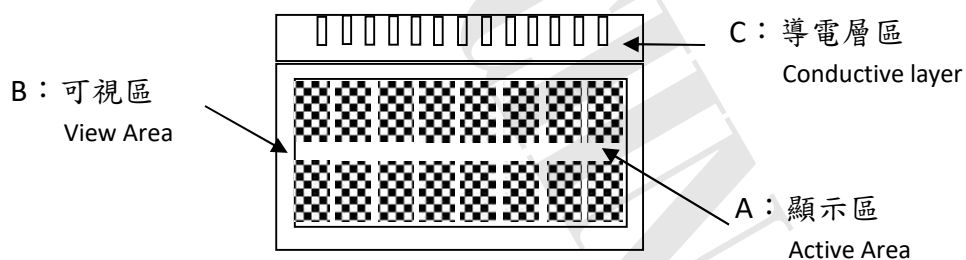

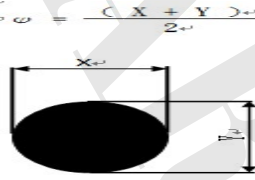
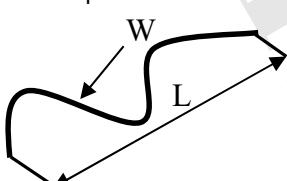
種類 Category		TFT																
編號 No.	檢驗項目 Item	檢驗內容及判定標準 Inspection Content & Standard	區域 Zone	類別 Category	缺陷等級 Level													
1	點類(一) Dot (1)	氣泡...圓狀 Bubble ...round shape 	兩點距離須超過 5 mm Two points have to be ≥ 5 mm <table border="1"> <tr> <th>ϕ (mm)</th> <th>允收數 Acceptance Qty</th> </tr> <tr> <td>$\phi \leq 0.25$</td> <td>無視 Ignore</td> </tr> <tr> <td>$0.25 < \phi \leq 0.5$</td> <td>3</td> </tr> <tr> <td>$\phi > 0.5$</td> <td>0</td> </tr> </table>	ϕ (mm)	允收數 Acceptance Qty	$\phi \leq 0.25$	無視 Ignore	$0.25 < \phi \leq 0.5$	3	$\phi > 0.5$	0	A	外觀 Appearance	次要 Minor AQL0.65%				
ϕ (mm)	允收數 Acceptance Qty																	
$\phi \leq 0.25$	無視 Ignore																	
$0.25 < \phi \leq 0.5$	3																	
$\phi > 0.5$	0																	
2	線類 Line	刮傷、毛屑...等線狀 Scratch、Fiber.. and other linear shape. 	<table border="1"> <tr> <th>L (mm)</th> <th>W (mm)</th> <th>允收數 Acceptance Qty</th> </tr> <tr> <td>--</td> <td>$W \leq 0.01$</td> <td>無視 Ignore</td> </tr> <tr> <td>$L \leq 3$</td> <td>$0.01 < W \leq 0.05$</td> <td>3</td> </tr> <tr> <td>$L > 3$</td> <td>$W > 0.05$</td> <td>0</td> </tr> </table>	L (mm)	W (mm)	允收數 Acceptance Qty	--	$W \leq 0.01$	無視 Ignore	$L \leq 3$	$0.01 < W \leq 0.05$	3	$L > 3$	$W > 0.05$	0	A	外觀 Appearance	次要 Minor AQL0.65%
L (mm)	W (mm)	允收數 Acceptance Qty																
--	$W \leq 0.01$	無視 Ignore																
$L \leq 3$	$0.01 < W \leq 0.05$	3																
$L > 3$	$W > 0.05$	0																
3	FPC 外觀 FPC Appearance	※ FPC 上刺傷導致線路無法導通 拒收 Stabbing on the FPC causes the line to fail to conduct Reject ※ FPC 上髒污或是殘留異物以致線路無法導通 拒收 Dirty or residual foreign matter on the FPC makes the circuit unable to conduct Reject ※ FPC 直角折痕、斷裂 拒收 FPC right-angle crease and fracture Reject	C	外觀 Appearance	次要 Minor AQL0.65%													
4	點類(二) Dot (2)	<table border="1"> <tr> <th>類型 Type</th> <th>允收數 Acceptance Qty</th> </tr> <tr> <td>亮點 Highlights</td> <td>$N \leq 2$</td> </tr> <tr> <td>暗點 dark spot</td> <td>$N \leq 3$</td> </tr> </table> ※ 缺陷點面積暫全點 1/2 則為一個缺陷點 Temporarily full area of defect point 1/2 is a defect point ※ 亮點：於黑畫面中使用 2% ND Filter 遮蓋須不可見 Highlights: Use 2% ND Filter in a black screen to cover up invisible ※ 暗點：在純紅、綠、藍模式下判定 Dark spot: judged in pure red, green and blue mode	類型 Type	允收數 Acceptance Qty	亮點 Highlights	$N \leq 2$	暗點 dark spot	$N \leq 3$	AA	電訊 Electronics	次要 Minor AQL0.65%							
類型 Type	允收數 Acceptance Qty																	
亮點 Highlights	$N \leq 2$																	
暗點 dark spot	$N \leq 3$																	

5	無動作 No reaction	顯示畫面一直處於起始畫面而無法進行切換 拒收 The display (view area) always shows in the initial screen and can't be switched to others. Reject	AA	電訊 Electronics	主要 Major AQL 0.4%
6	無畫面 No display	通電後，完全無任何畫面顯示 拒收 After connecting to the power, there is no display. Reject	AA	電訊 Electronics	主要 Major AQL 0.4%
7	斷線 Broken line	顯示畫面中少直、橫線 拒收 There is a lack of vertical or horizontal lines in the view area. Reject	AA	電訊 Electronics	主要 Major AQL 0.4%
8	I CON	顯示畫面缺少部份顯示圖案 拒收 Lack of partial ICON in the view area. Reject	AA	電訊 Electronics	主要 Major AQL 0.4%
9	深淺不一 Color difference	顯示畫面的對比，比其他顯示深或淺並依電氣規格(VOP)值判定 The contrast of display is obviously lighter or darker than others and according to the VOP value in the electronics specification. 拒收或與客端簽訂限度樣 Reject or inspect according to the golden sample	AA	電訊 Electronics	次要 Minor AQL0.65%
10	畫面異常 Abnormal screen	通電後畫面出現未定義之電訊不良現象 拒收 After connecting to the power, there is a undefined electronics appearance showing in the view area. Reject	AA	電訊 Electronics	主要 Major AQL 0.4%
11	牛頓環 Newton ring	點亮後目視有環、圓或曲線狀 拒收 There are rings, circles or curves visually after lighting Reject	A	電訊 Electronics	次要 Minor AQL0.65%
12	背光色不均 Uneven color of backlight	※ 點亮後 LED 有明暗不均現象依其均勻度判定 拒收 After lighting LEDs have brightness and darkness uneven the determined according to its uniformity. Reject ※ 點亮後 LED 色澤不一致 拒收 LED color is inconsistent after lighting Reject	A	電訊 Electronics	次要 Minor AQL0.65%
13	亮度不足 Lack of brightness	波長、色座標、輝度與圖面標示定義不符 拒收 Wave length, chromatic coordinates, brightness don't correspond to the definition of the drawing. Reject	A	電訊 Electronics	主要 Major AQL 0.4%

TFT

14	觸控 Touch	測試時無法點觸或劃，其靈敏度判定則依 SPEC 上定義判定 拒收 It cannot be touched or swiped during the test. Its sensitivity is judged according to the definition on SPEC Reject	A	電訊 Electronics	主要 Major AQL 0.4%
15	尺寸量測 Size Measurement	未依圖面上標示 拒收 No correspond to the indication on the drawing. Reject	ALL	外觀 Appearance	主要 Major AQL 0.4%
16	其他 Other	如發現有上述未定義之不良則與客端簽訂限度樣 If there is another undefined defective situation. It will be listed as others. The inspection standard is according to the golden sample.	ALL	電訊 Electronics 外觀 Appearance	次要 Minor AQL0.65%