

### General information

Part number	G80LOC-P03LJG0-0000
Termination	solder
Size	0
Locking principle	break , push
Coding	0_key

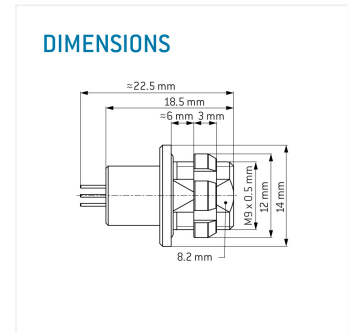
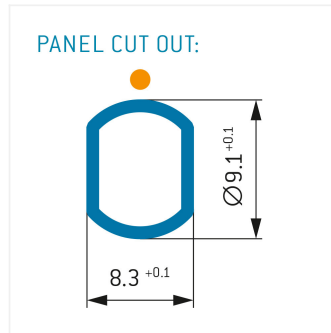
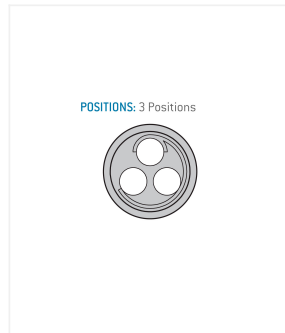
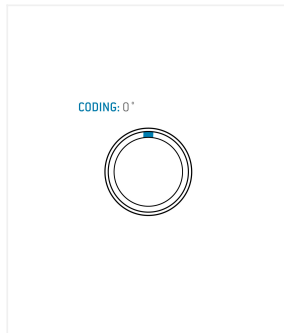

### Contact insert description

Number of contacts	3
Contact type	sockets
Contact diameter	09mm
Insulator material	peek
Wire cross section	22_awg
Termination	solder
Termination diameter	085mm

reverse\_gender\_on\_request

### Technical information

Max. creepage and air clearance distance	08_mm	10_mm
Nominal current single contact	075_a	iec_60512_5_2
Nominal current insert	7,5 A	vde_0298_4
Test voltage	12_kv_ac	sae_13441

safety\_text

### Mechanical and environmental data

Degree of protection*	ip68
Operating temperature	40_120_c
Mating cycles	5000

unmated

### Material and surface treatments

<b>Housing</b>	m_chrome
<b>Contact</b>	cu_alloy_gold

safety\_text\_2  
ul\_text  
illustrative\_text