

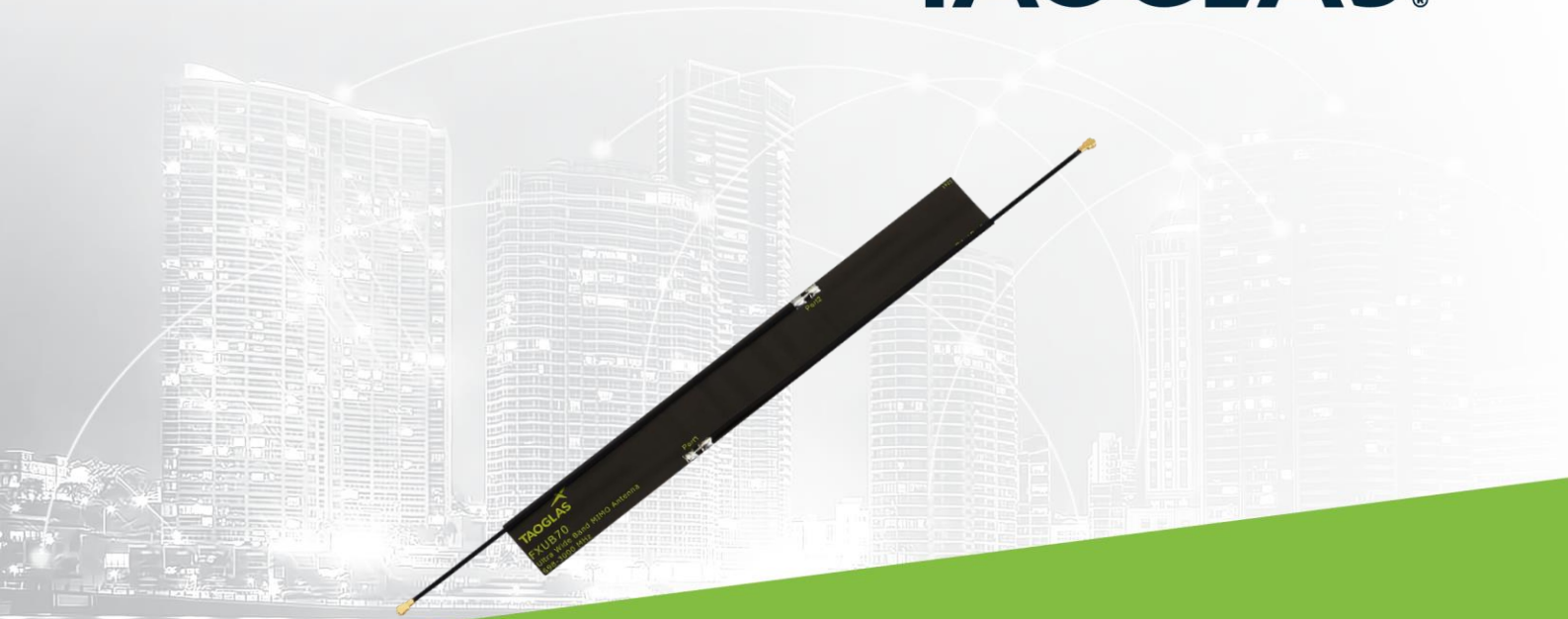

TAOGLAS®



Datasheet

4G LTE Wide Band Flex MIMO Antenna

698-3000MHz

Part No:

FXUB70.A.07.C.001

Description

FXUB70 Wide-band MIMO LTE Antenna

Features:

Patent Pending

Covers 4G LTE, 3G HSPA, 2G GSM/GPRS/CDMA

Ground Plane Independent

Covering: 698-3000MHz

5 dBi Peak Gain

Dimensions: 182mm *21mm *0.2mm

Cable : 150mm \varnothing 1.37mm

Connector: IPEX MHFI

RoHS & Reach Compliant

1.	Introduction	2
2.	Specification	3
3.	Antenna Characteristics	5
4.	Radiation Patterns	9
5.	Mechanical Drawing	24
6.	Packaging	25
	Changelog	27

Taoglas makes no warranties based on the accuracy or completeness of the contents of this document and reserves the right to make changes to specifications and product descriptions at any time without notice. Taoglas reserves all rights to this document and the information contained herein. Reproduction, use or disclosure to third parties without express permission is strictly prohibited.



1. Introduction



The patent pending FXUB70 LTE Wide-band flexible wideband antenna has been designed to cover all working frequencies in the 698-3000 MHz spectrum, covering all Cellular, 2.4GHz Wi-Fi, ISM and AGPS. The antenna is delivered with a flexible body with excellent efficiencies on all bands, ground independent, with cable and connector for easy installation.

The FXUB70 flexible polymer antenna, at 182*21*0.2mm, is ultra-thin and truly wideband with high efficiencies across the bands. It is assembled by a simple “peel and stick” process, attaching securely to non-metal surfaces via 3M 467 automotive approved adhesive. It enables designers to use only one antenna that covers all common frequencies for LTE and 4G globally.

The FXUB70 antenna is a durable flexible polymer antenna that has a peak gain of 5dBi, an efficiency of more than 45% across the bands and is designed to be mounted directly onto plastic. It is an ideal choice for any device maker that needs to keep manufacturing costs down over the lifetime of a product. It is ground plane independent and delivered with a cable and connector for easy connecting to the wireless module or customer PCB. Like all such antennas, care should be taken to mount the antenna at least 10mm from metal components or surfaces, and ideally 20mm for best radiation efficiency.

Cables and Connectors are customizable. If cable routing is not convenient on this antenna, the alternative FXUB71 is recommended.

2. Specification

LTE Electrical									
Band	Frequency (MHz)	Measurement	Efficiency (%)	Average Gain (dB)	Peak Gain (dBi)	Impedance	Polarization	Radiation Pattern	Max. input power
4G/3G_1	698-960	MIMO 1	57.2	-2.43	3.08	50 Ω	Linear	Omni	2W
		MIMO 2	50.9	-2.93	2.80				
4G/3G_7	1575-1602	MIMO 1	31.3	-5.04	1.33				
		MIMO 2	43.2	-3.65	0.92				
4G/3G_2	1710-1990	MIMO 1	40.5	-3.93	1.77				
		MIMO 2	52.5	-2.80	2.08				
4G/3G_6	1755-2170	MIMO 1	36.9	-4.33	1.77				
		MIMO 2	45.8	-3.39	2.27				
4G/3G_3	2305-2360	MIMO 1	59.3	-2.27	2.65				
		MIMO 2	63.7	-1.96	4.03				
4G/3G_4	2400-2500	MIMO 1	50.0	-3.01	2.67				
		MIMO 2	57.8	-2.38	3.08				
4G/3G_5	2500-2690	MIMO 1	48.2	-3.17	2.67				
		MIMO 2	58.5	-2.33	2.85				

Mechanical	
Dimensions	182*21*0.2 mm
Material	Flexible Polymer
Connector	U.FL
Cable	1.37 mm mini coax with 150 mm

Environmental	
Operation Temperature	-40°C to +85°C
Storage Temperature	-40°C to +85°C
Relative Humidity	40% to 95%
RoHs & REACH Compliant	Yes

All results were obtained with the FXUB70 mounted on a piece of 3mm ABS (210x297)mm

5G/4G Bands				
Band Number	5GNR / FR1 / LTE / LTE-Advanced / WCDMA / HSPA / HSPA+ / TD-SCDMA			
	Uplink	Downlink	FXUB70_MIMO1_Chamber_3m mABS	FXUB70_MIMO2_Chamber_3m mABS
B1	1920 to 1980	2110 to 2170	✓	✓
B2	1850 to 1910	1930 to 1990	✓	✓
B3	1710 to 1785	1805 to 1880	✓	✓
B4	1710 to 1755	2110 to 2155	✓	✓
B5	824 to 849	869 to 894	✓	✓
B7	2500 to 2570	2620 to 2690	✓	✓
B8	880 to 915	925 to 960	✓	✓
B9*	1749.9 to 1784.9	1844.9 to 1879.9	✓	✓
B11	1427.9 to 1447.9	1475.9 to 1495.9	✗	✗
B12	699 to 716	729 to 746	✓	✓
B13	777 to 787	746 to 756	✓	✓
B14	788 to 798	758 to 768	✓	✓
B17	704 to 716	734 to 746	✓	✓
B18	815 to 830	860 to 875	✓	✓
B19	830 to 845	875 to 890	✓	✓
B20	832 to 862	791 to 821	✓	✓
B21	1447.9 to 1462.9	1495.9 to 1510.9	✗	✗
B22*	3410 to 3490	3510 to 3590	✗	✗
B23*	2000 to 2020	2180 to 2200	✓	✓
B24	1626.5 to 1660.5	1525 to 1559	✓	✓
B25	1850 to 1915	1930 to 1995	✓	✓
B26	814 to 849	859 to 894	✓	✓
B27*	807 to 824	852 to 869	✓	✓
B28	703 to 748	758 to 803	✓	✓
B29		717 to 728	✓	✓
B30	2305 to 2315	2350 to 2360	✓	✓
B31	452.5 to 457.5	462.5 to 467.5	✓	✓
B32		1452 to 1496	✗	✗
B34		2010 to 2025	✓	✓
B35		1850 to 1910	✓	✓
B36		1930 to 1990	✓	✓
B37		1910 to 1930	✓	✓
B38		2570 to 2620	✓	✓
B39		1880 to 1920	✓	✓
B40		2300 to 2400	✓	✓
B41		2496 to 2690	✓	✓
B42		3400 to 3600	✗	✗
B43		3600 to 3800	✗	✗
B45		1447 to 1467	✗	✗
B46		5150 to 5925	✗	✗
B47		5855 to 5925	✗	✗
B48		3550 to 3700	✗	✗
B49		3550 to 3700	✗	✗
B50		1432 to 1517	✗	✗
B51		1427 to 1432	✗	✓
B52		3300 to 3400	✗	✗
B53		2483.5 to 2495	✓	✓
B65	1920 to 2010	2110 to 2200	✓	✓
B66	1710 to 1780	2110 to 2200	✓	✓
B68	698 to 728	753 to 783	✓	✓
B69		2570 to 2620	✓	✓
B70	1695 to 1710	1995 to 2020	✓	✓
B71	663 to 698	617 to 652	✓	✓
B72	451 to 456	461 to 466	✓	✓
B73	450 to 455	460 to 465	✓	✓
B74	1427 to 1470	1475 to 1518	✗	✗
B75		1432 to 1517	✗	✗
B76		1427 to 1432	✗	✓
B77		3300 to 4200	✗	✗
B78		3300 to 3800	✗	✗
B79		4400 to 5000	✗	✗
B85	698 to 716	728 to 746	✓	✓
B87	410 to 415	420 to 425	✓	✓
B88	412 to 417	422 to 427	✓	✓

3. Antenna Characteristics

3.1 Test Setup

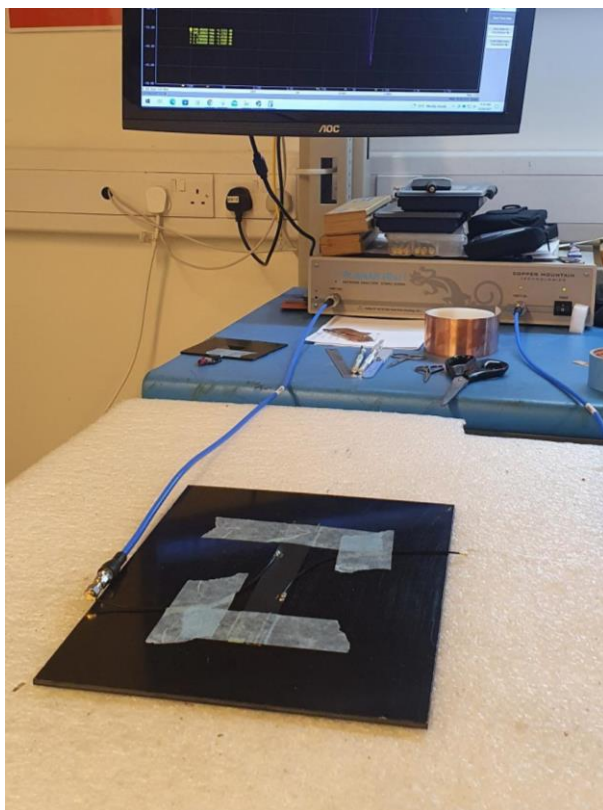
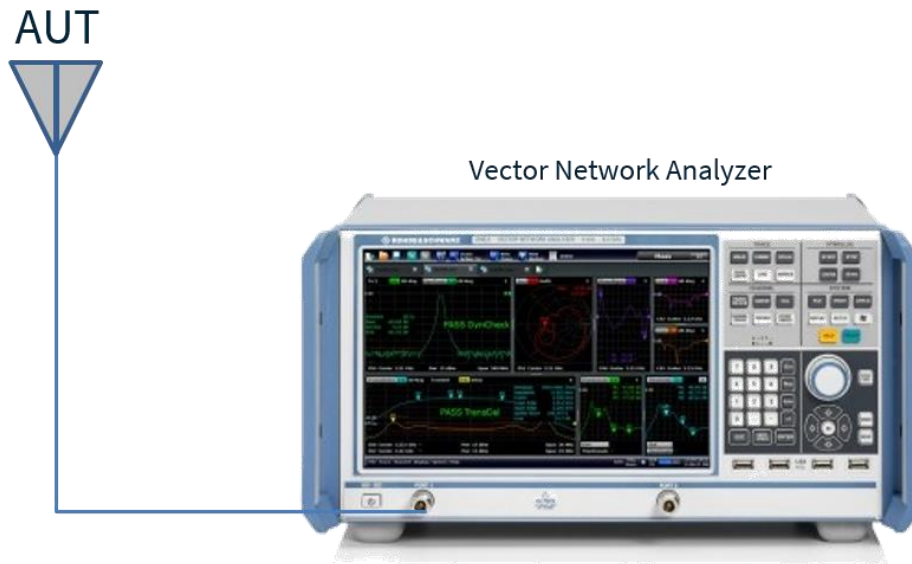

FXUB70 Port 2 Setup

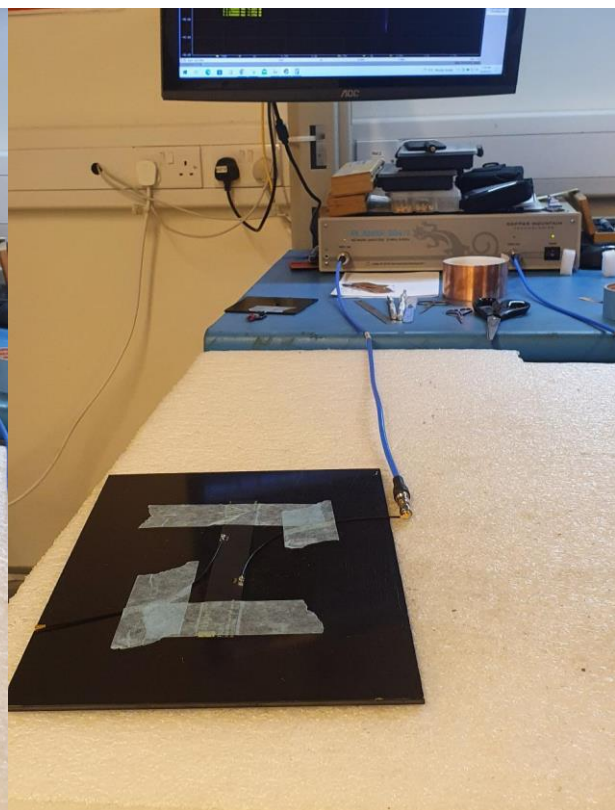

FXUB70 Port 1 Setup

3.2 Return Loss

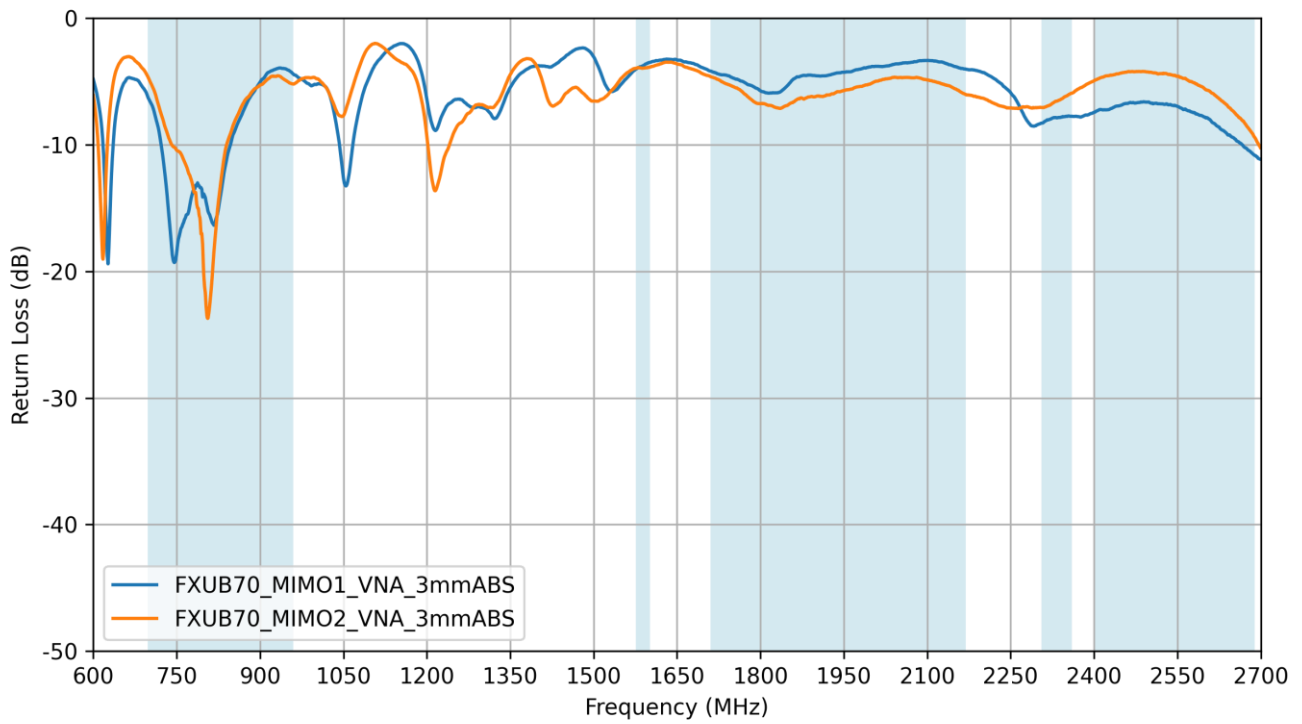

3.3 VSWR

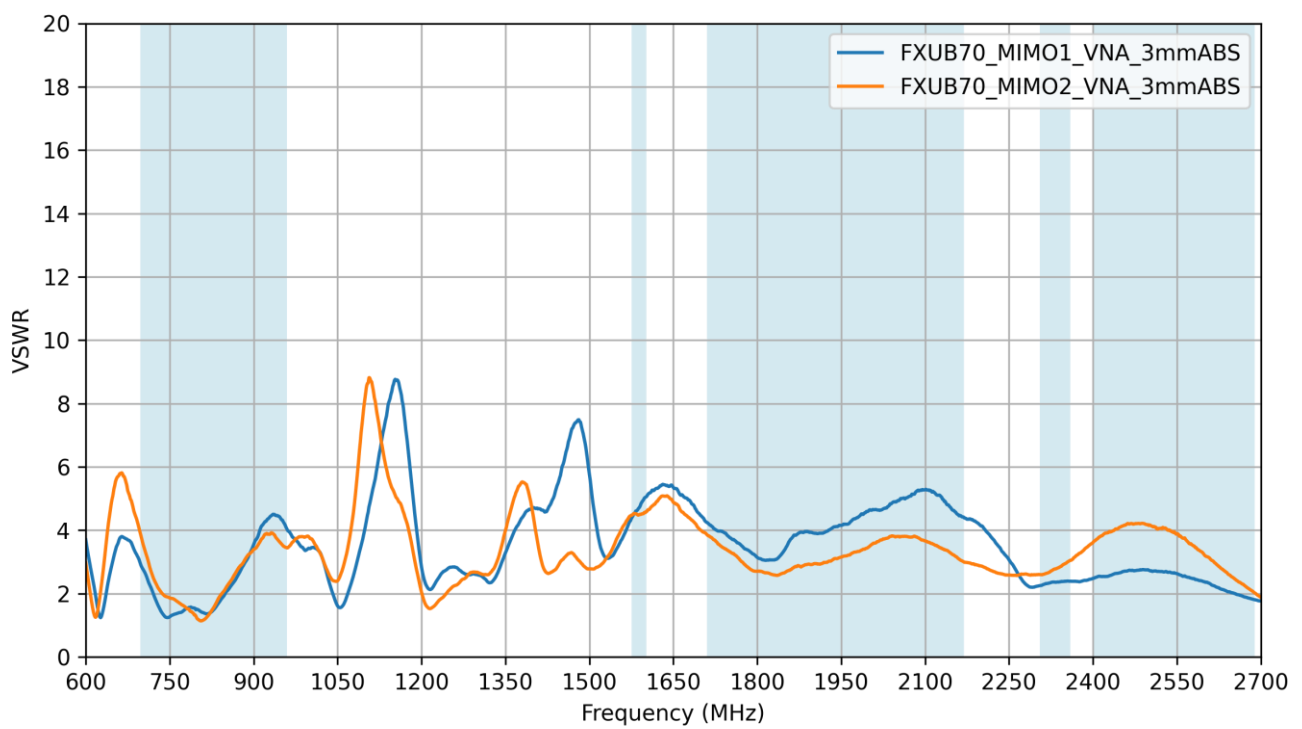

3.4 Isolation

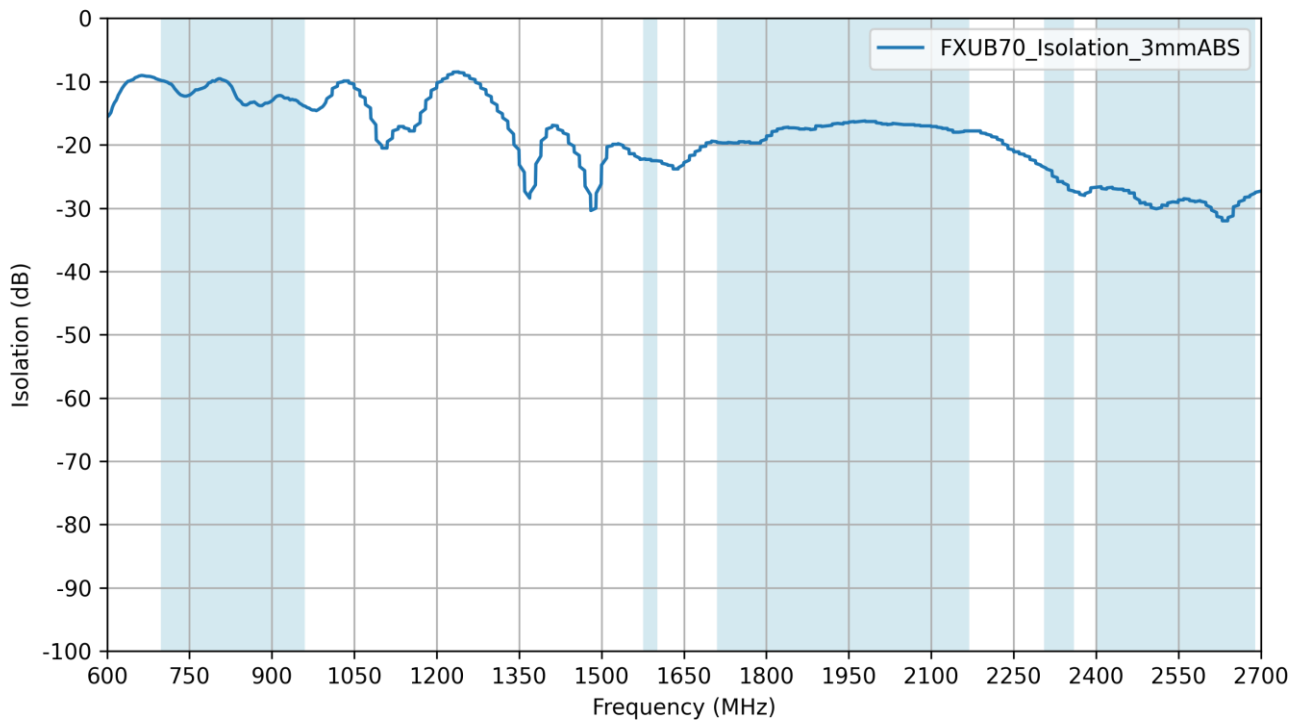

3.5 Efficiency

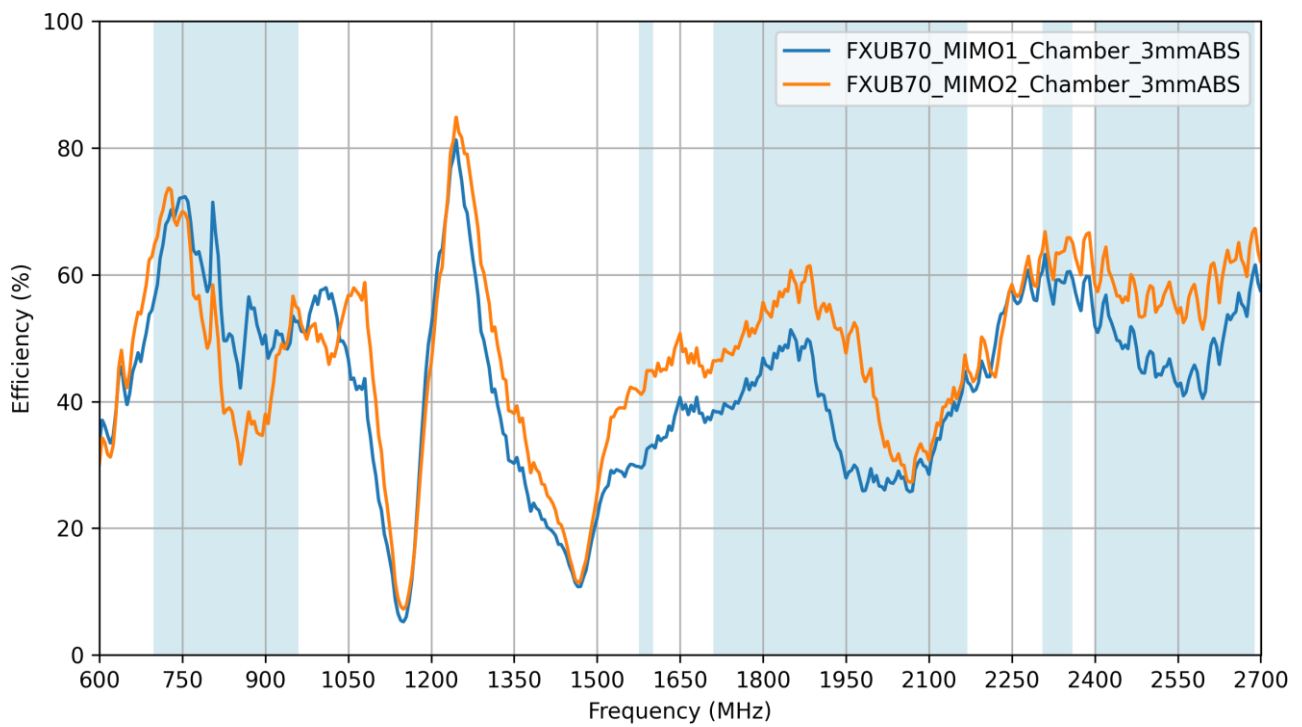

3.6 Average Gain

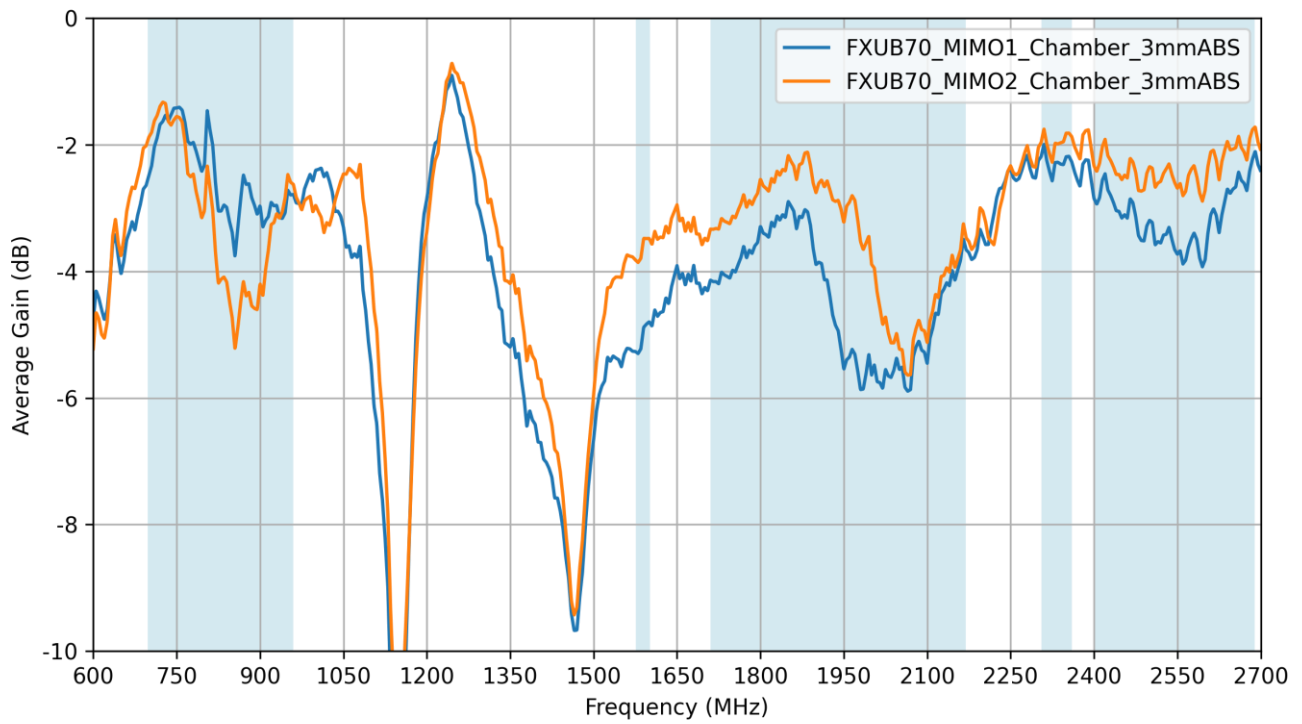

3.7 Peak Gain

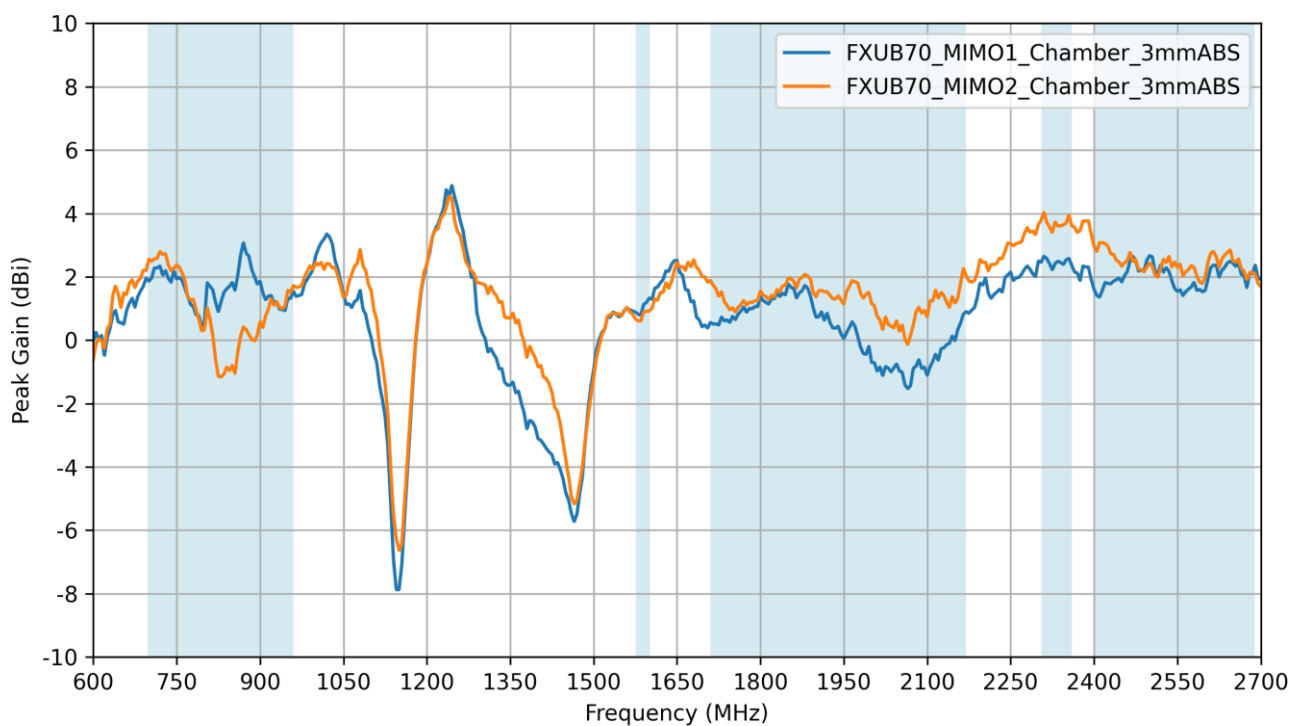

4. Radiation Patterns

4.1 Test Setup

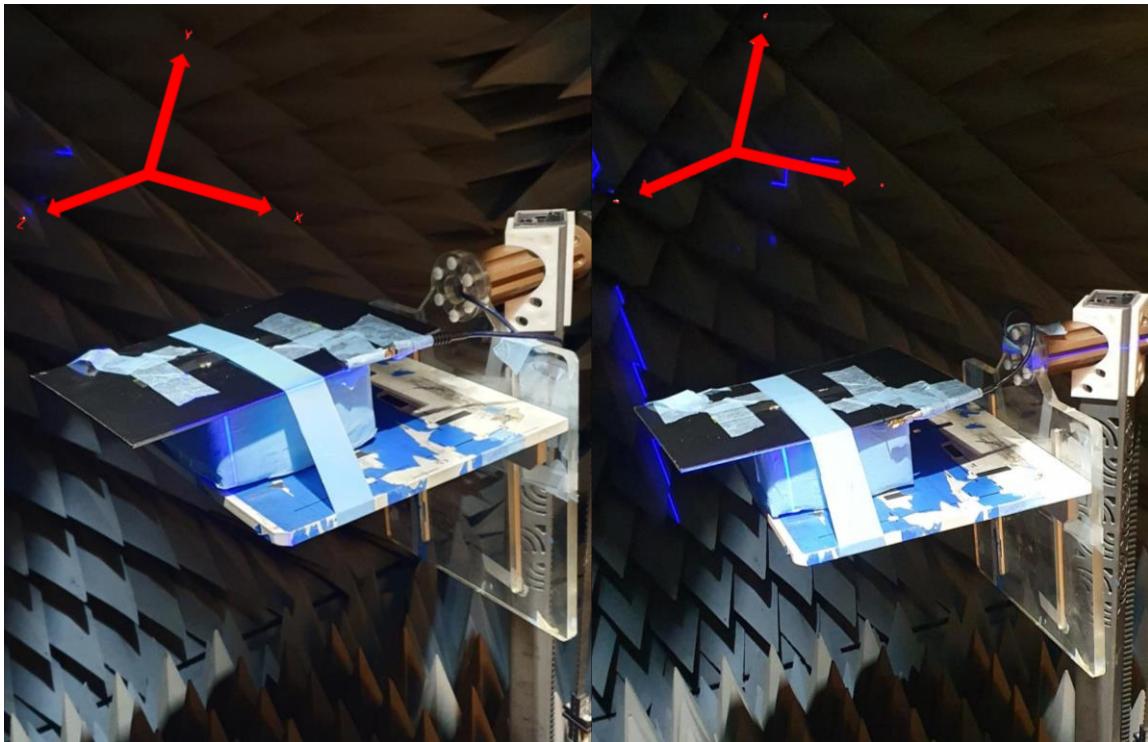
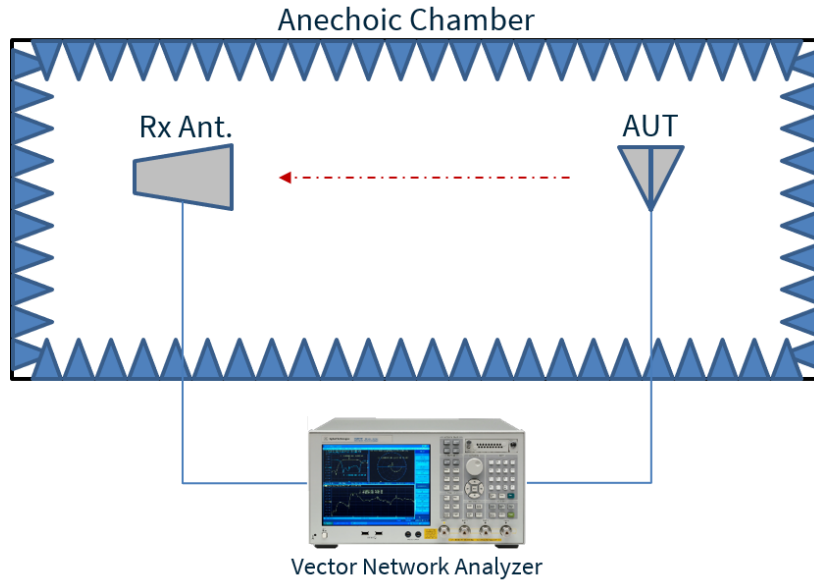

FXUB70 Port 2 Setup

FXUB70 Port 1 Setup

4.2 FXUB70_MIMO1_3mmABS - Patterns at 829 MHz

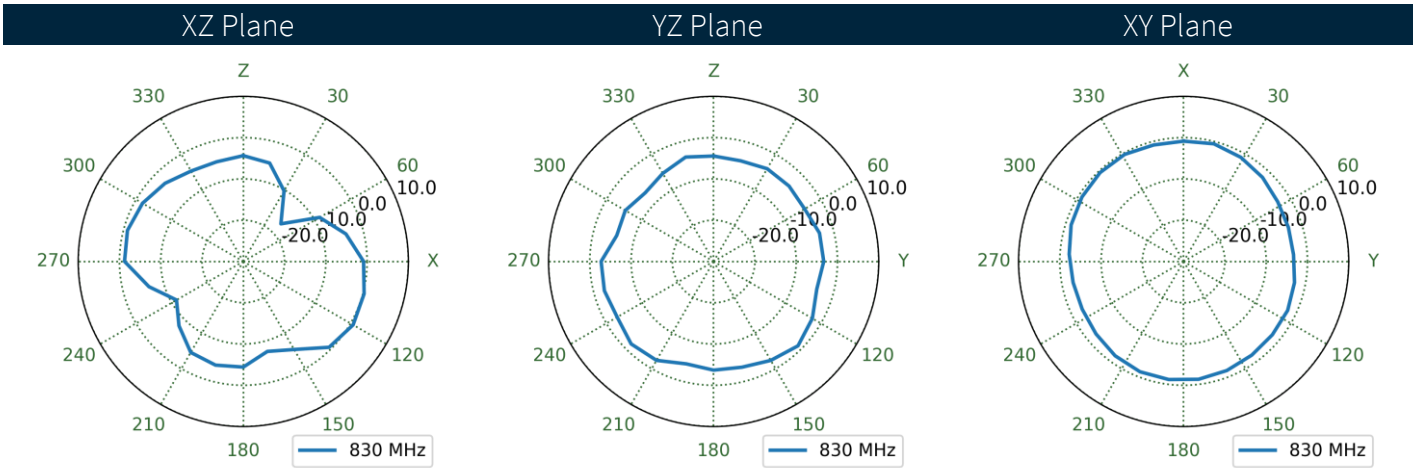
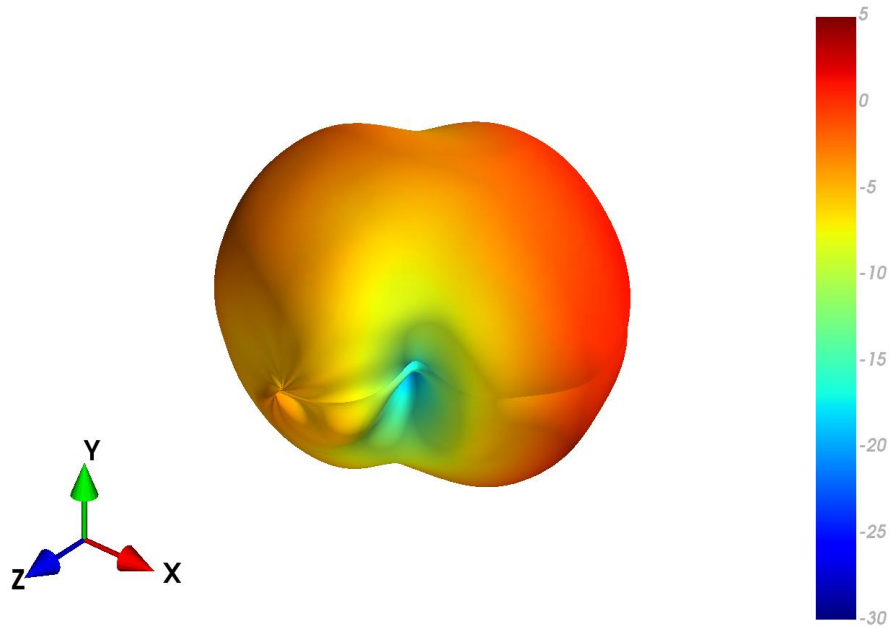

4.3 FXUB70_MIMO2_3mmABS - Patterns at 829 MHz

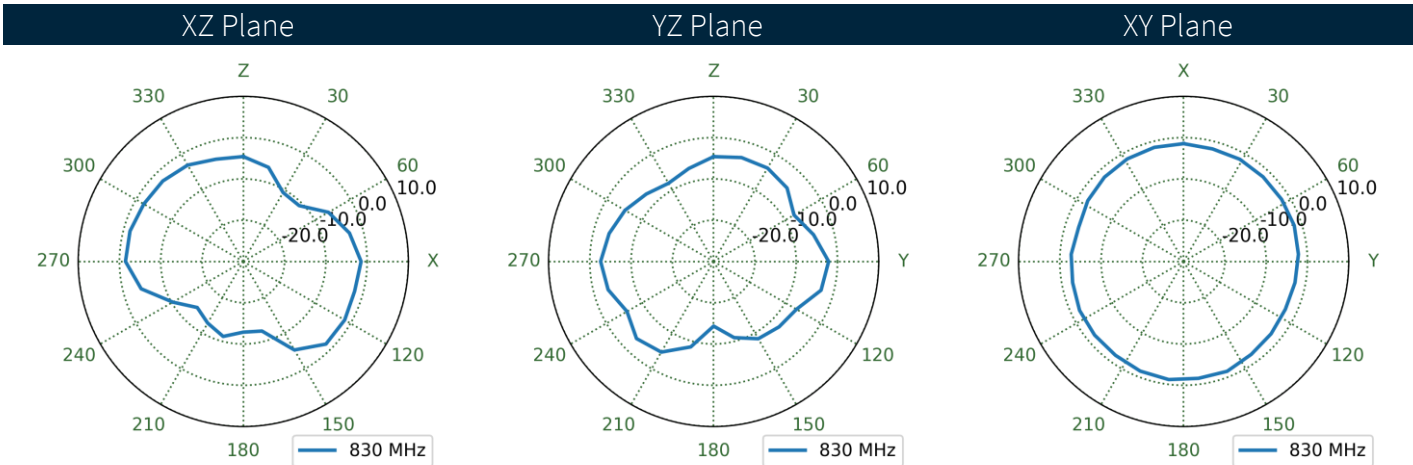
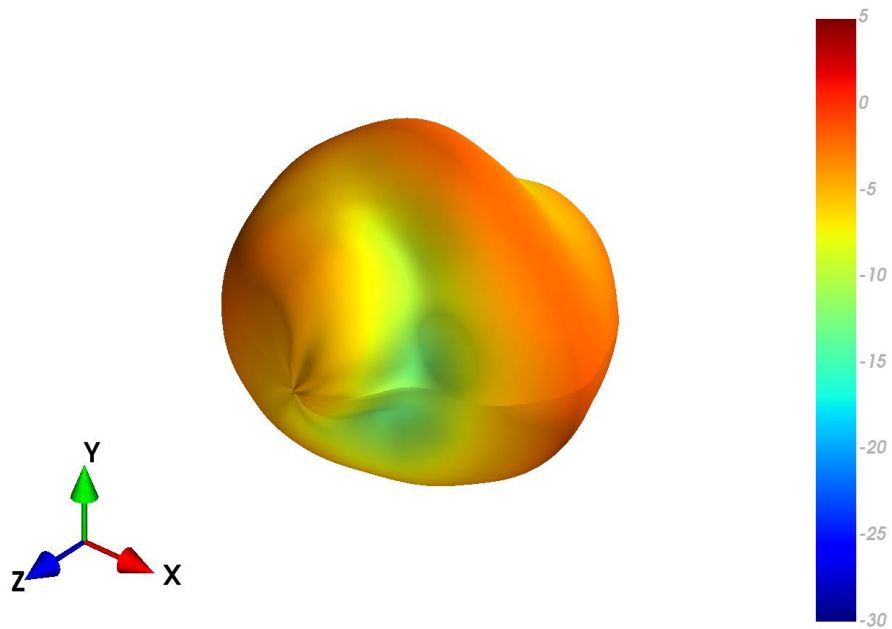

4.4 FXUB70_MIMO1_3mmABS - Patterns at 1589 MHz

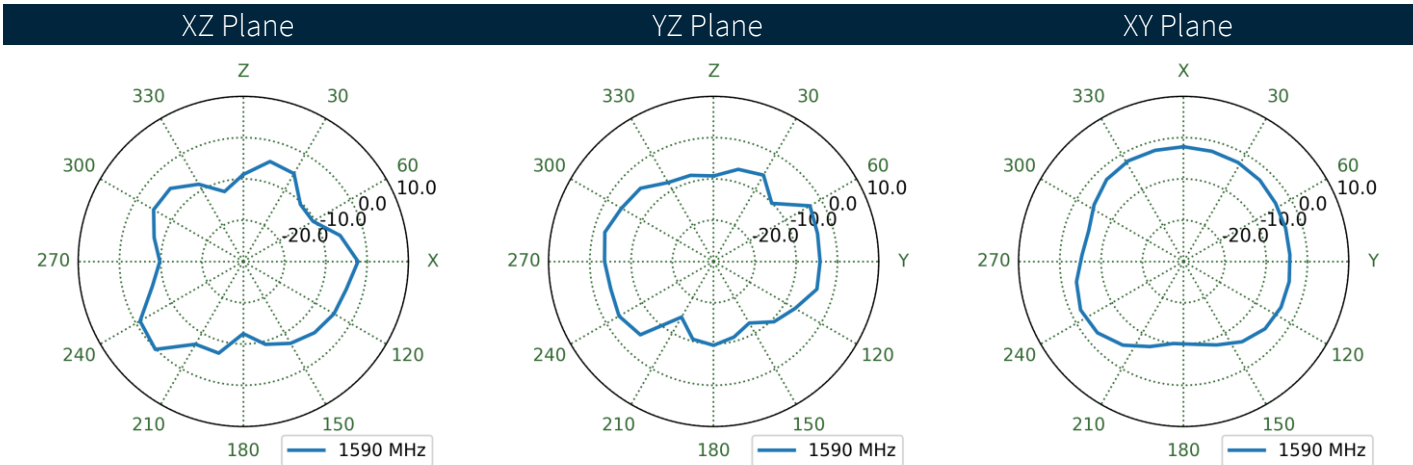
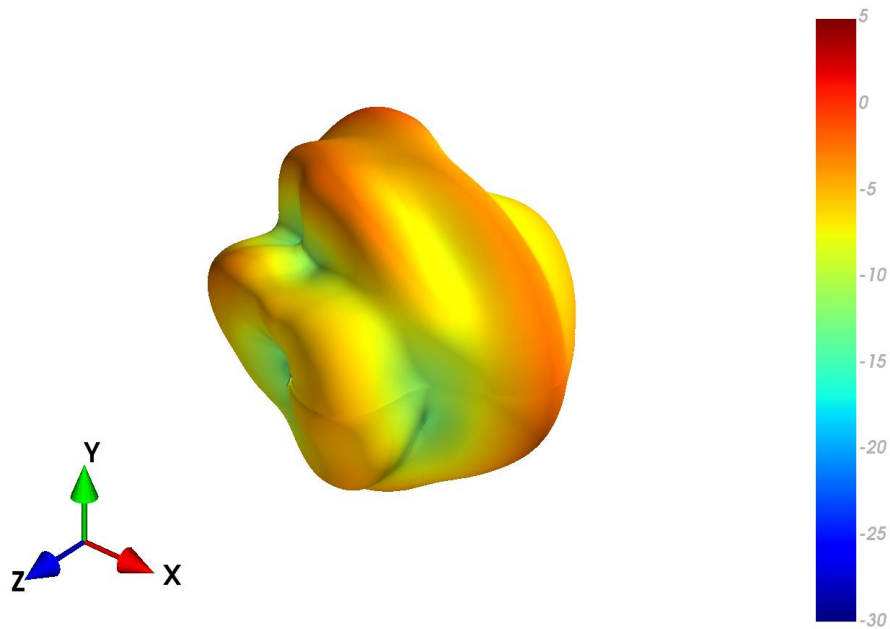

4.5 FXUB70_MIMO2_3mmABS - Patterns at 1589 MHz

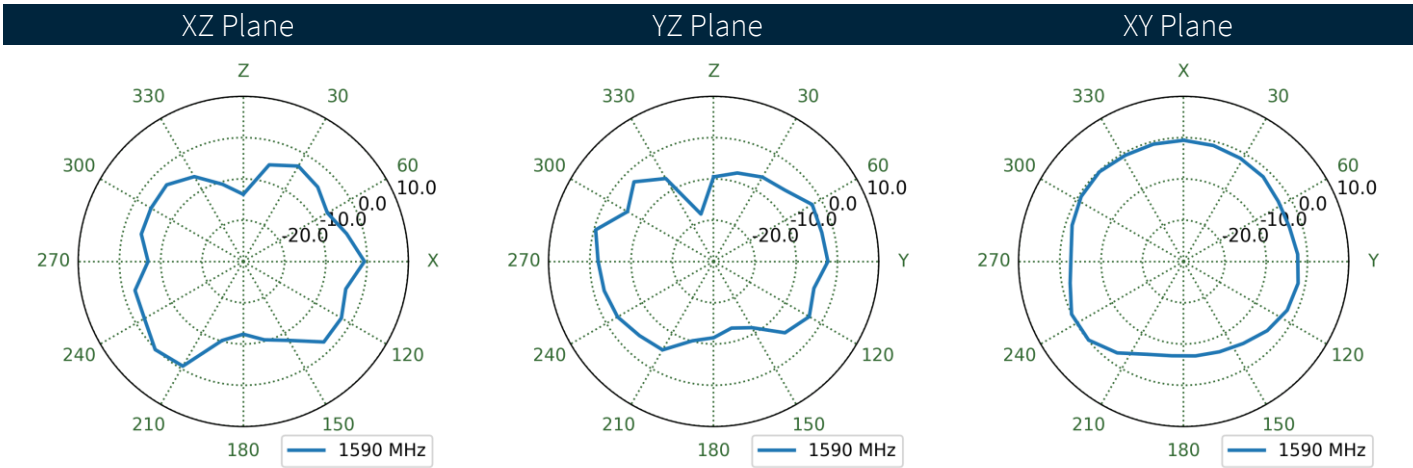
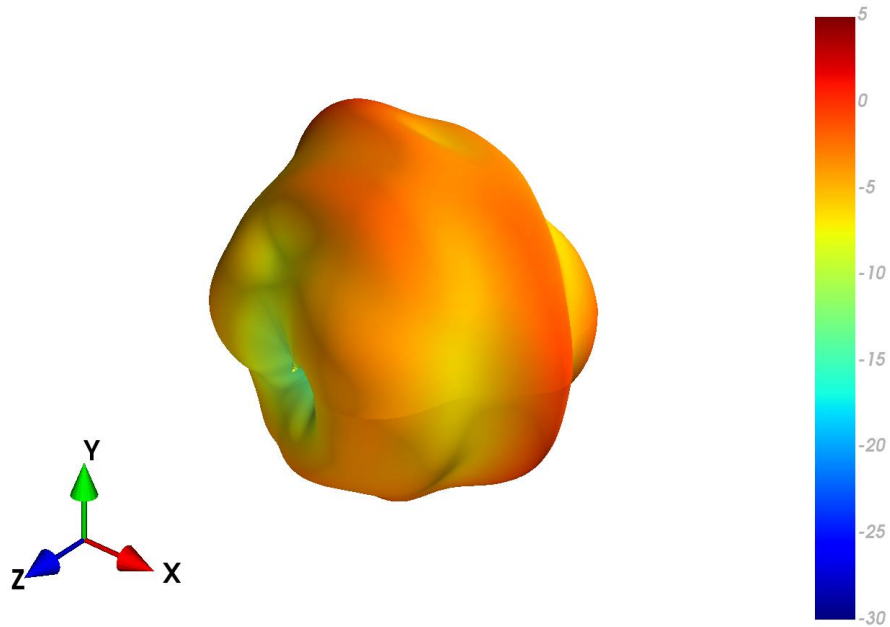

4.6 FXUB70_MIMO1_3mmABS - Patterns at 1850 MHz

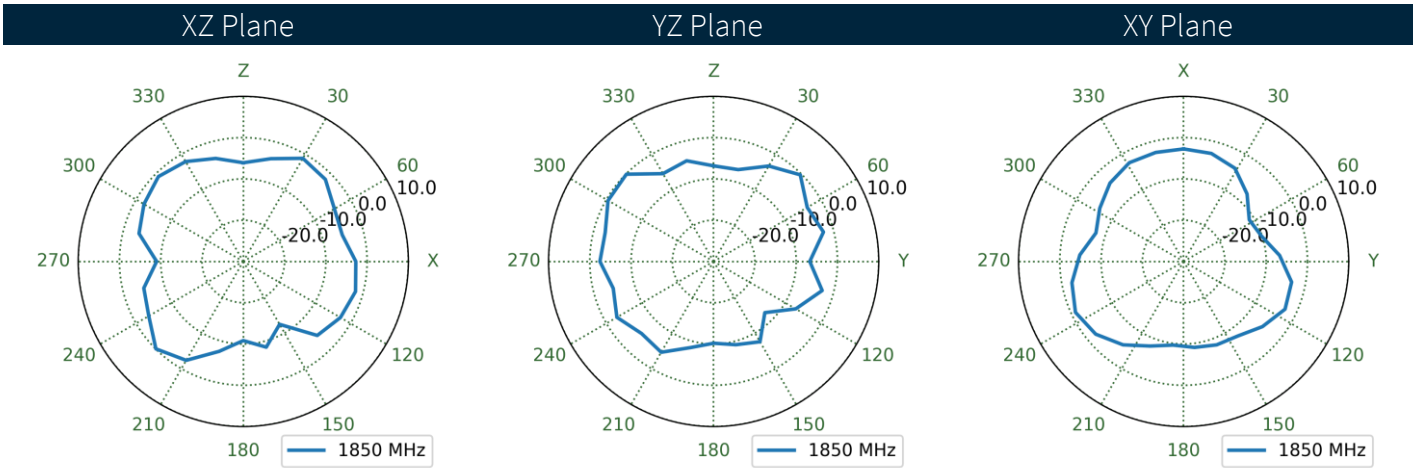
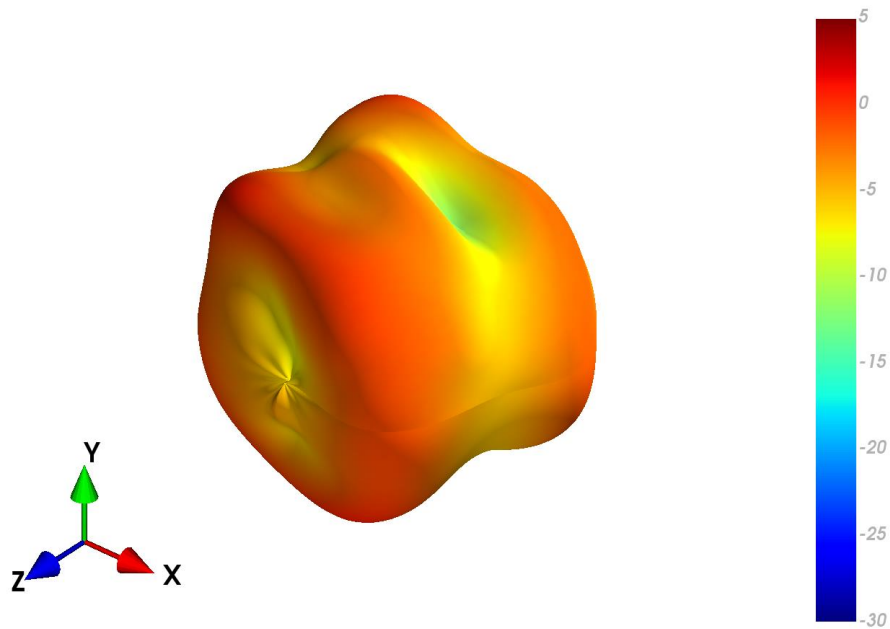

4.7 FXUB70_MIMO2_3mmABS - Patterns at 1850 MHz

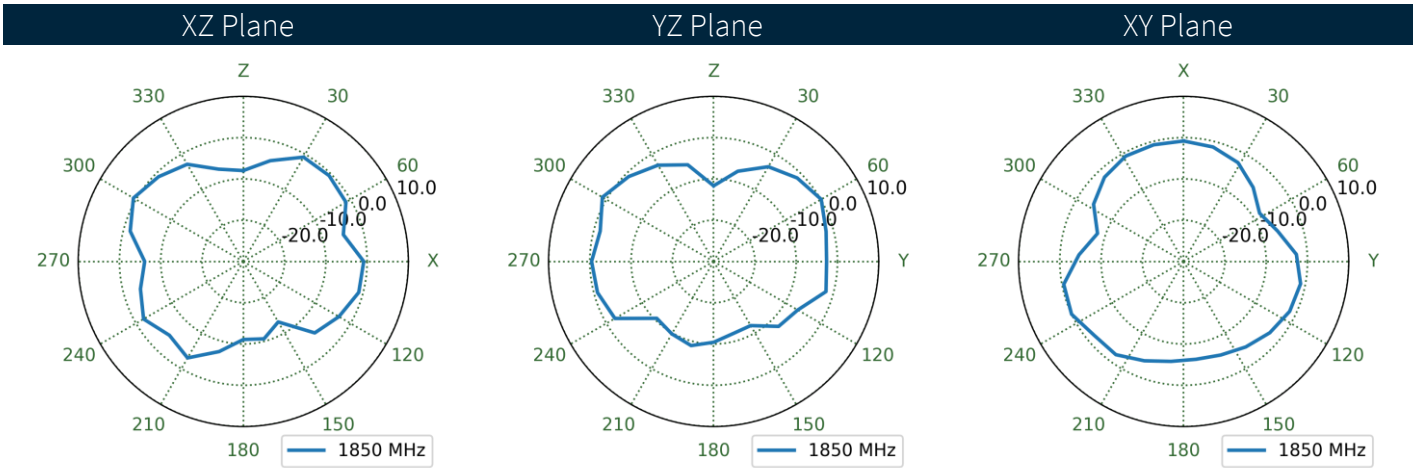
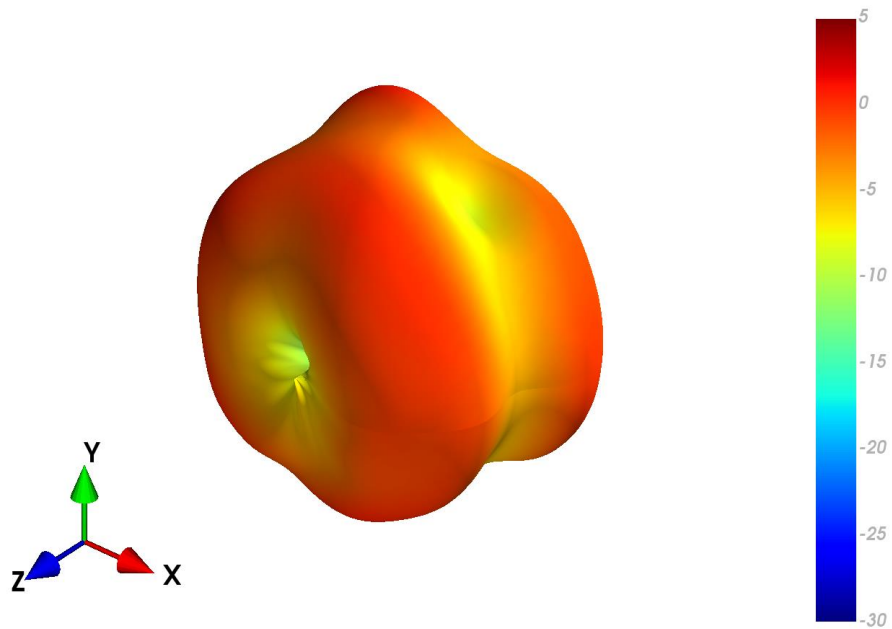

4.8 FXUB70_MIMO1_3mmABS - Patterns at 1963 MHz

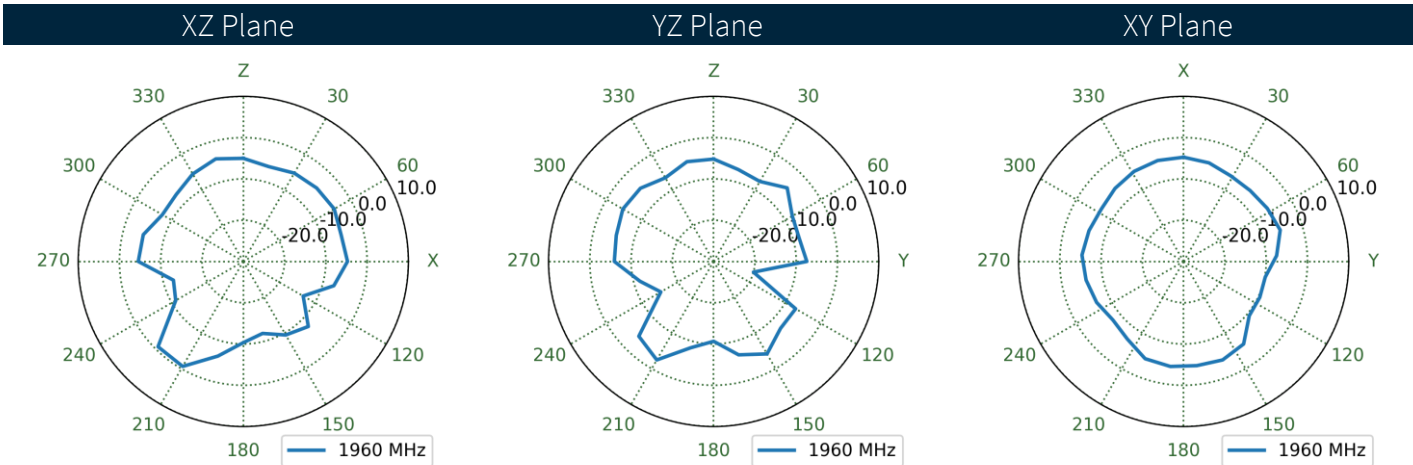
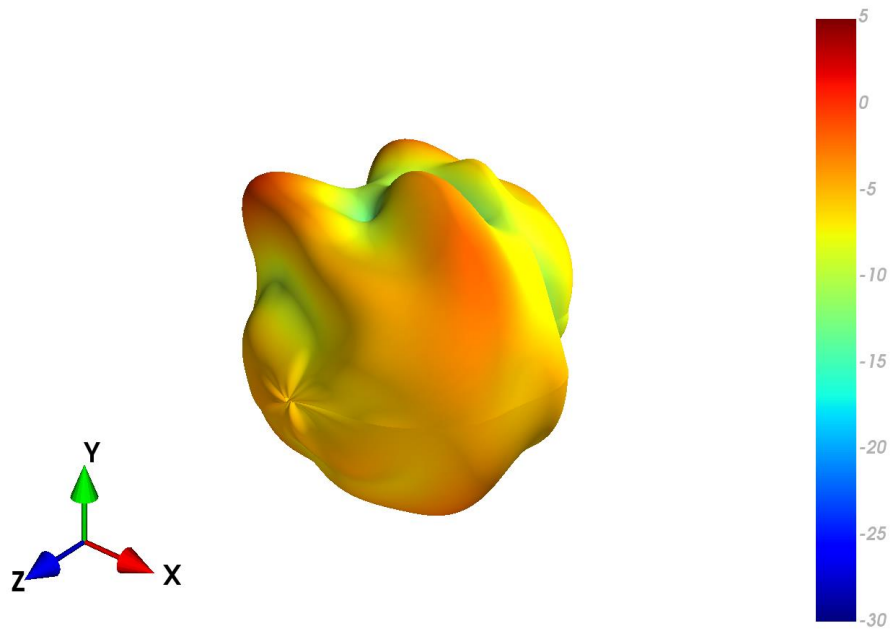

4.9 FXUB70_MIMO2_3mmABS - Patterns at 1963 MHz

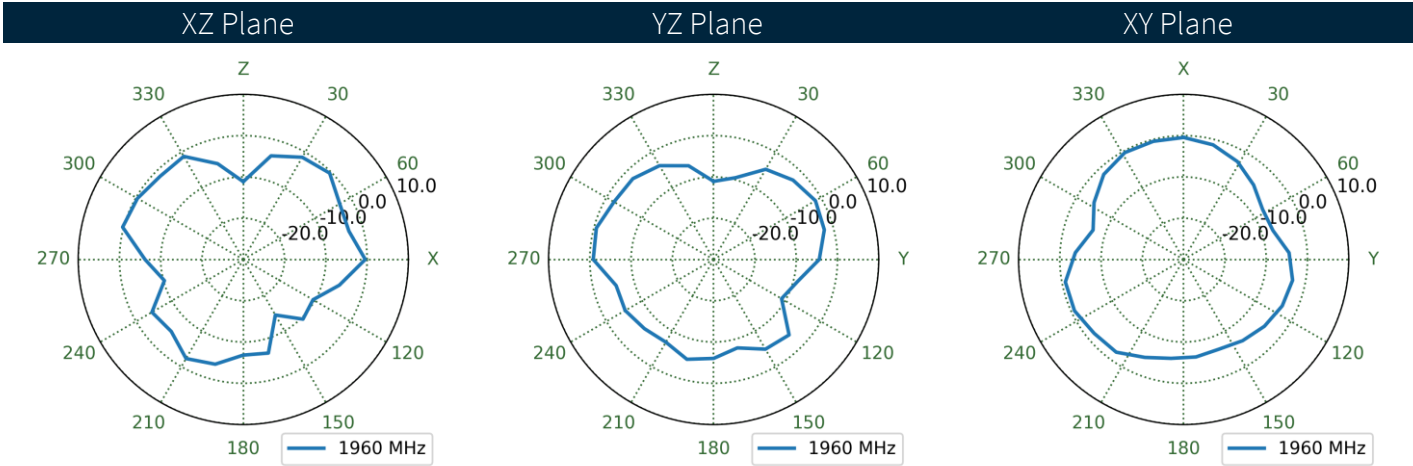
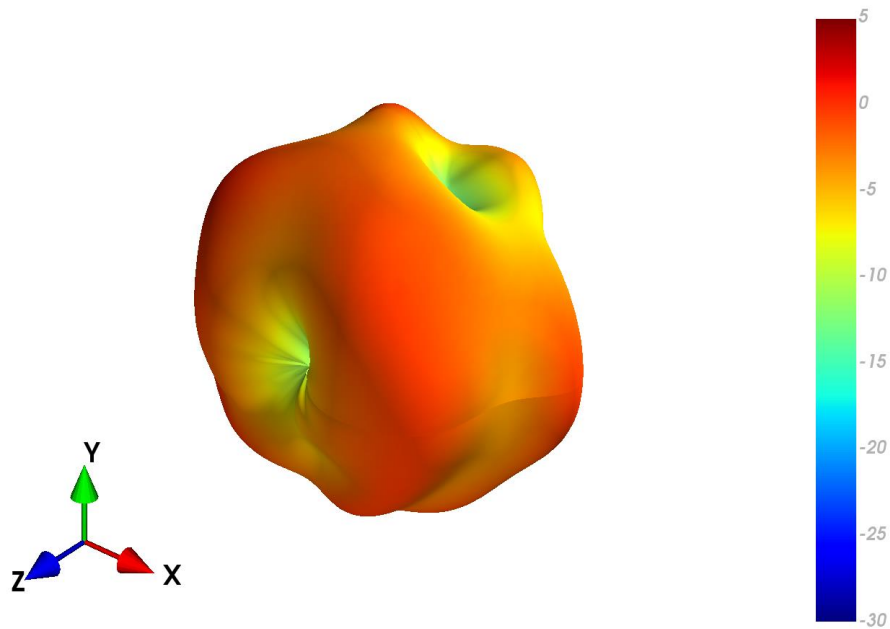

4.10 FXUB70_MIMO1_3mmABS - Patterns at 2333 MHz

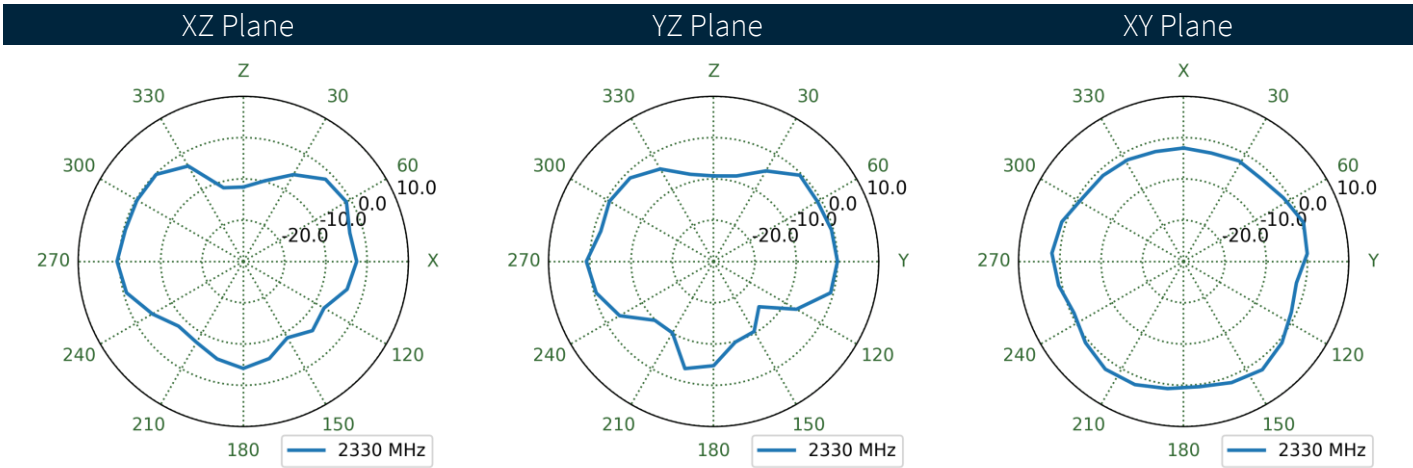
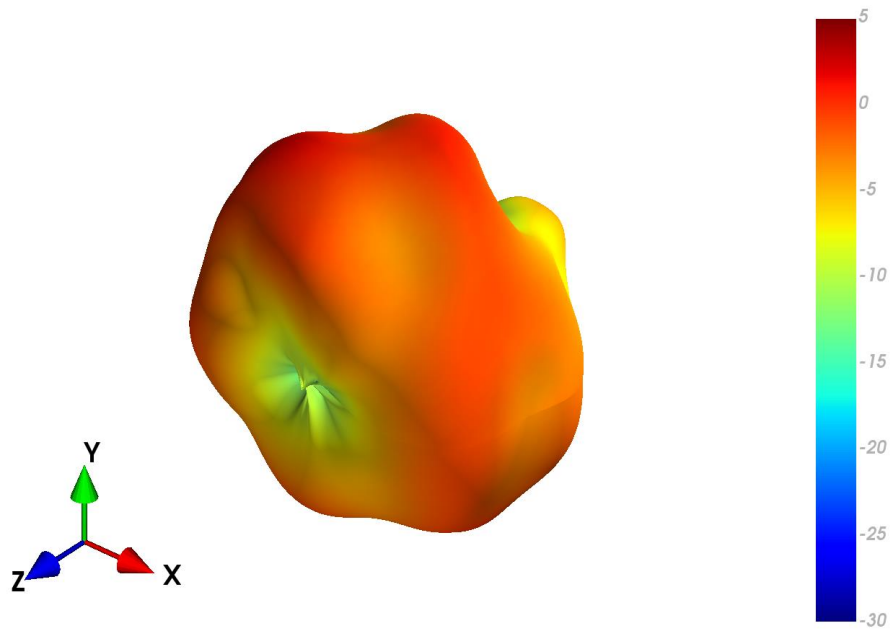

4.11 FXUB70_MIMO2_3mmABS - Patterns at 2333 MHz

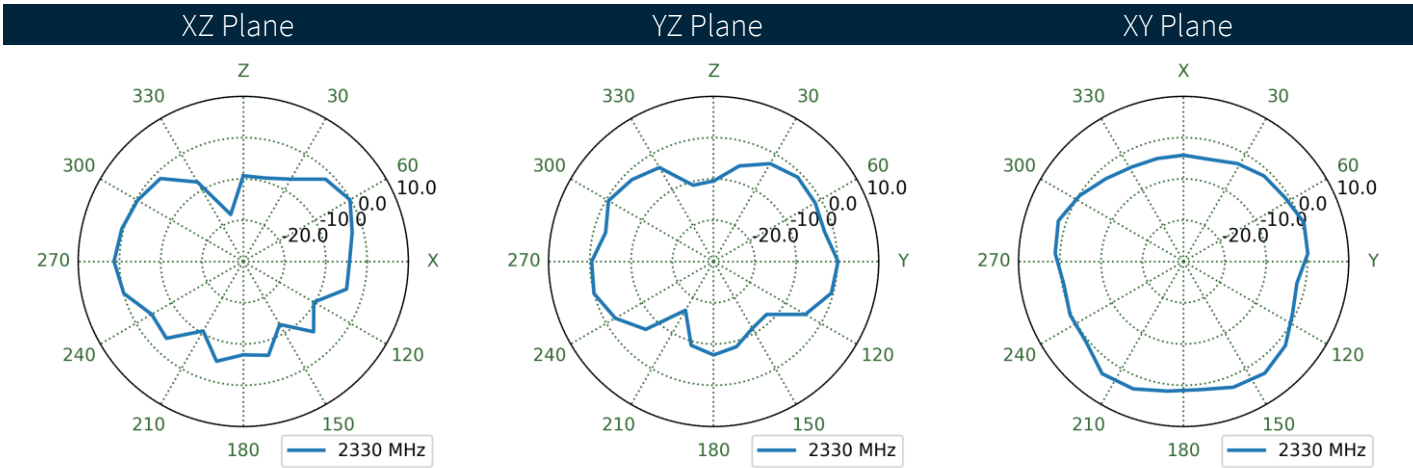
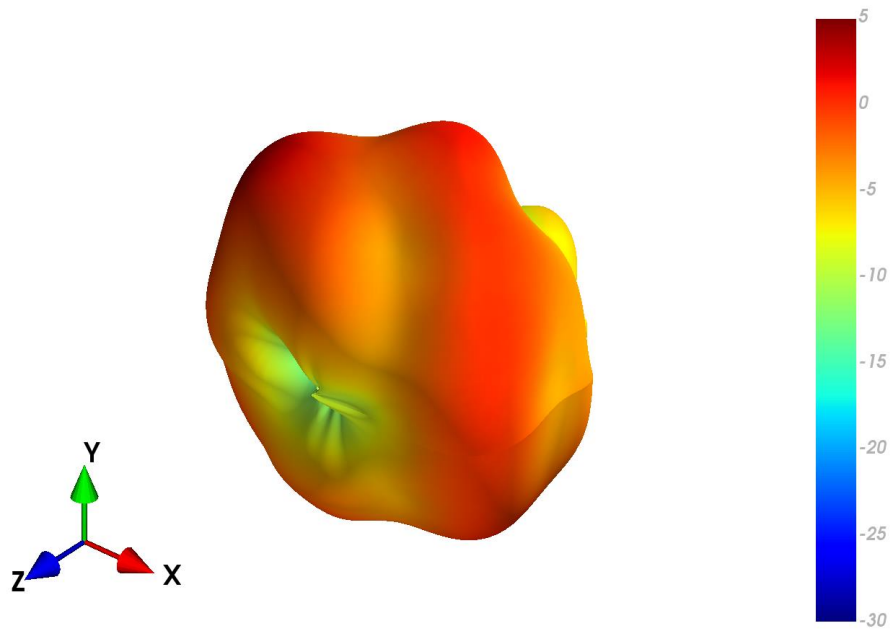

4.12 FXUB70_MIMO1_3mmABS - Patterns at 2450 MHz

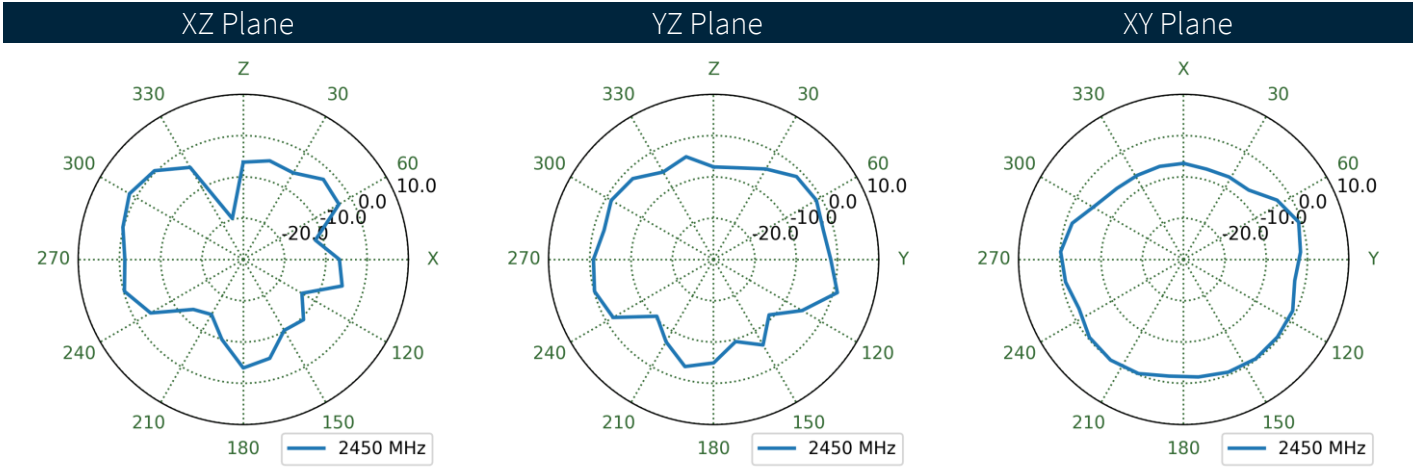
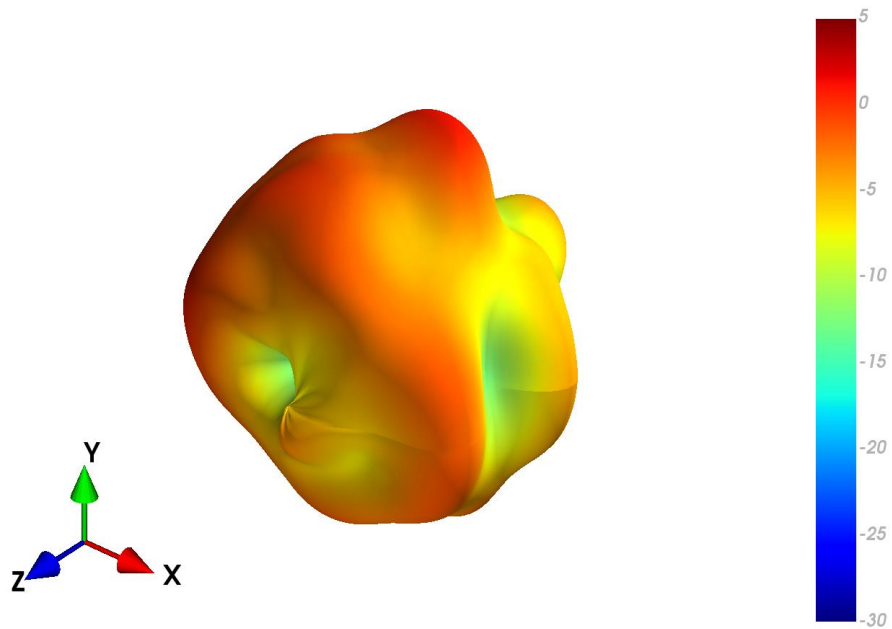

4.13 FXUB70_MIMO2_3mmABS - Patterns at 2450 MHz

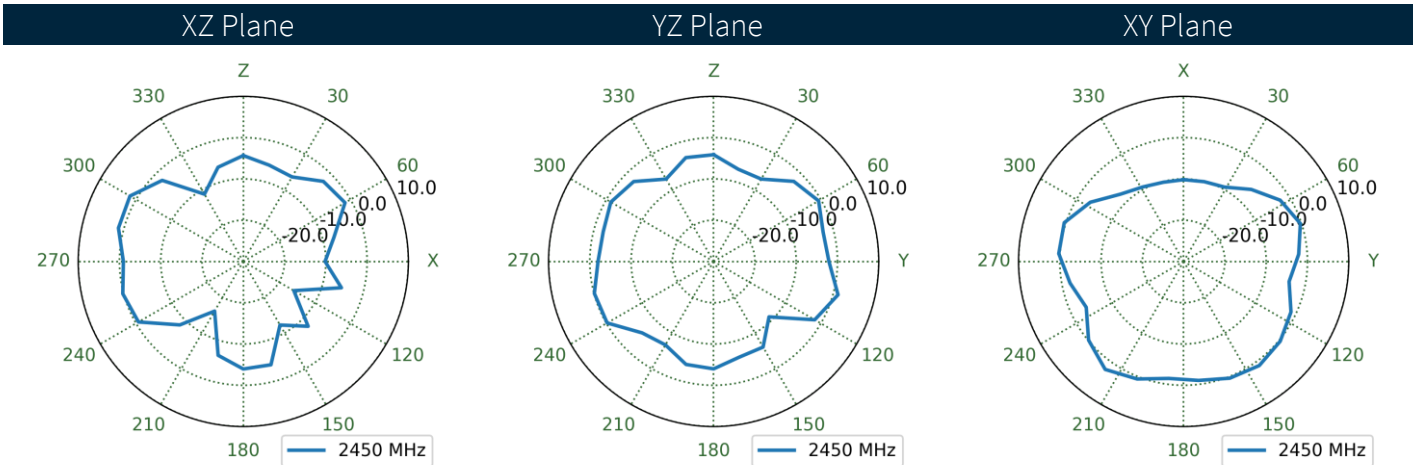
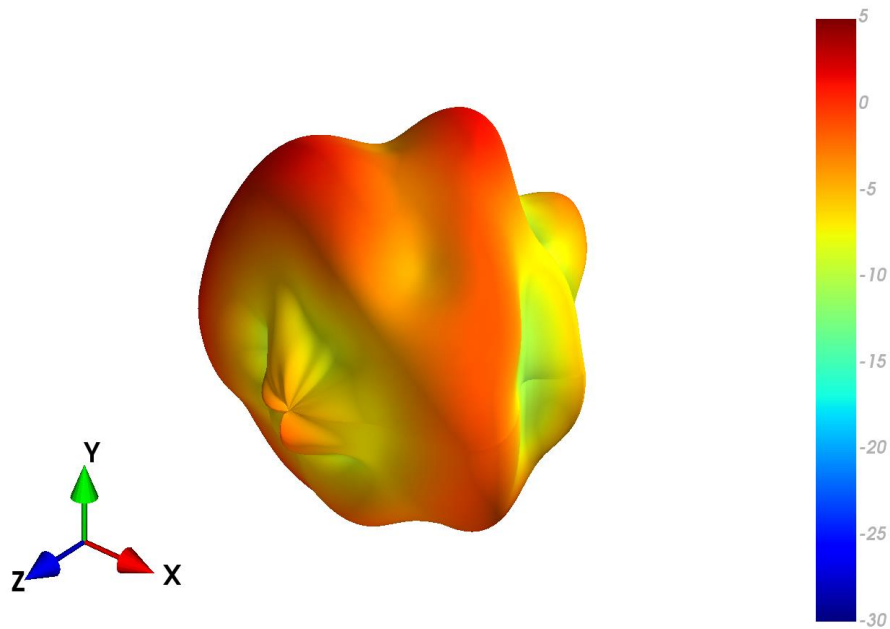

4.14 FXUB70_MIMO1_Chamber_3mmABS Patterns at 2595 MHz

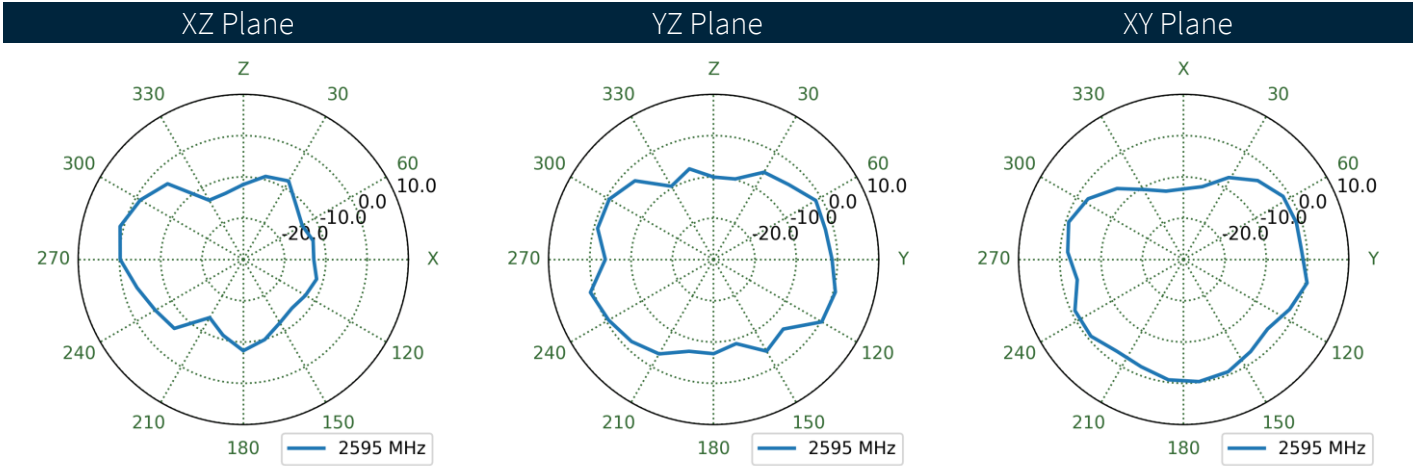
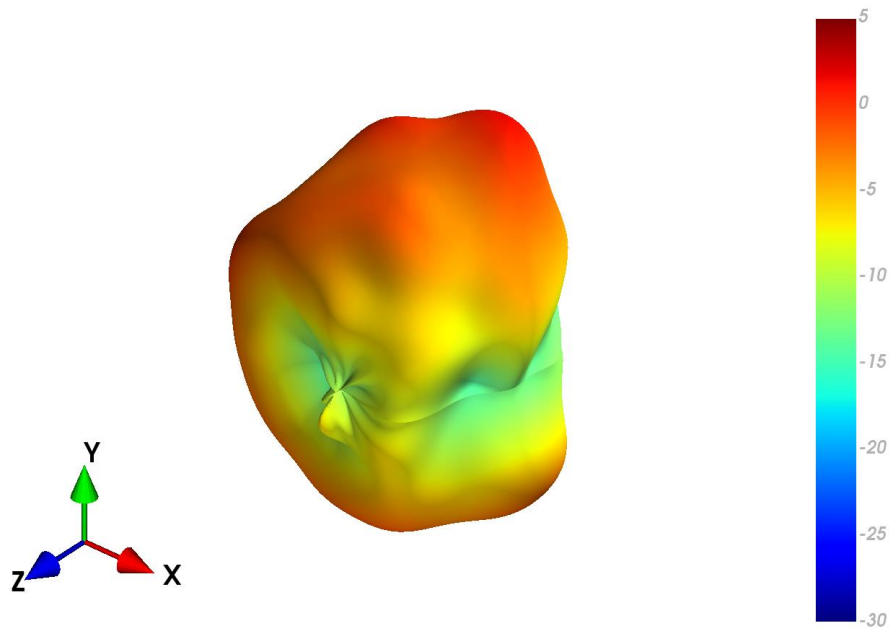

4.15 FXUB70_MIMO2_3mmABS - Patterns at 2595 MHz

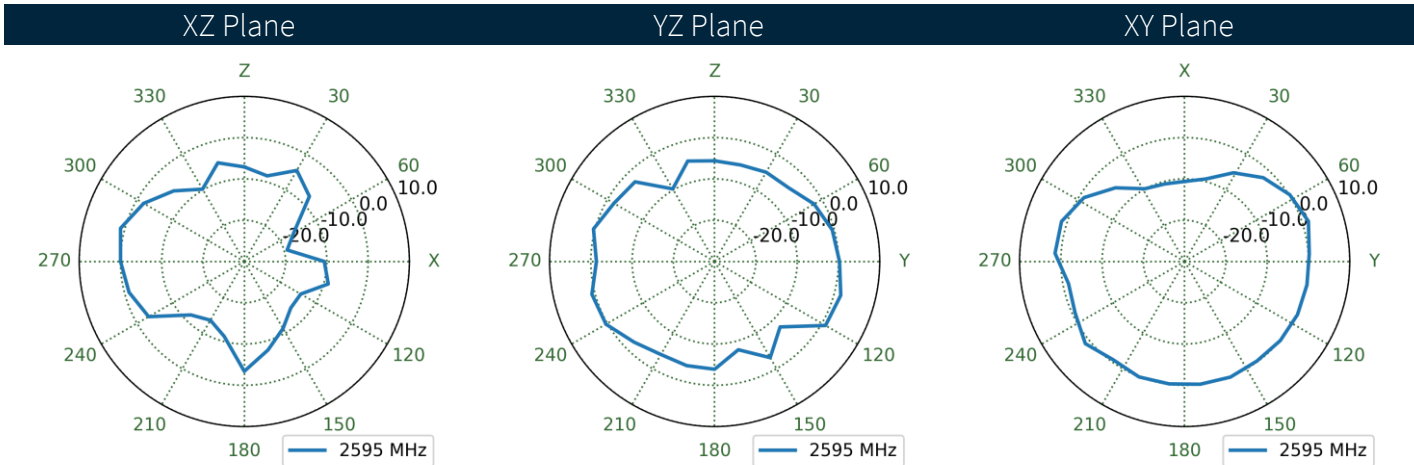
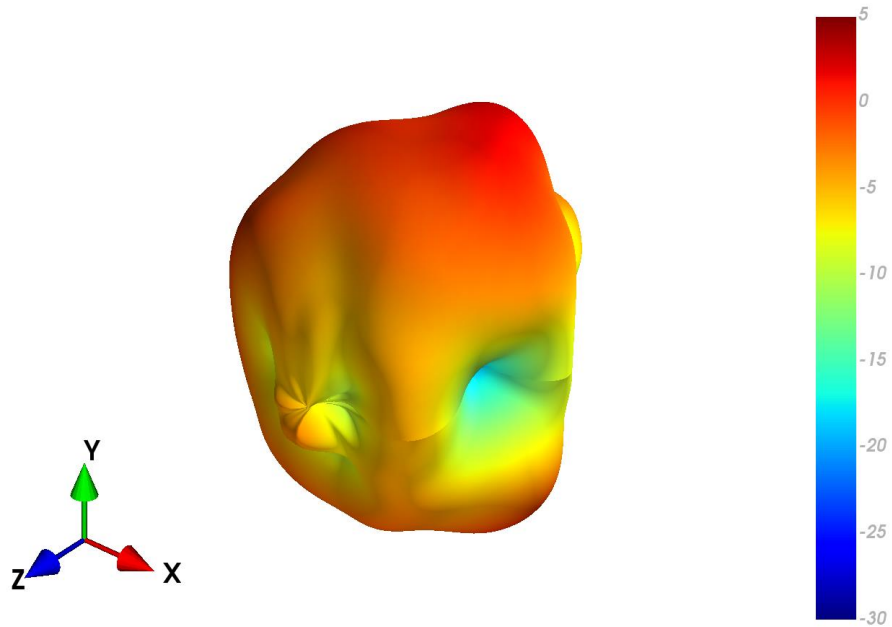

5. Mechanical Drawing

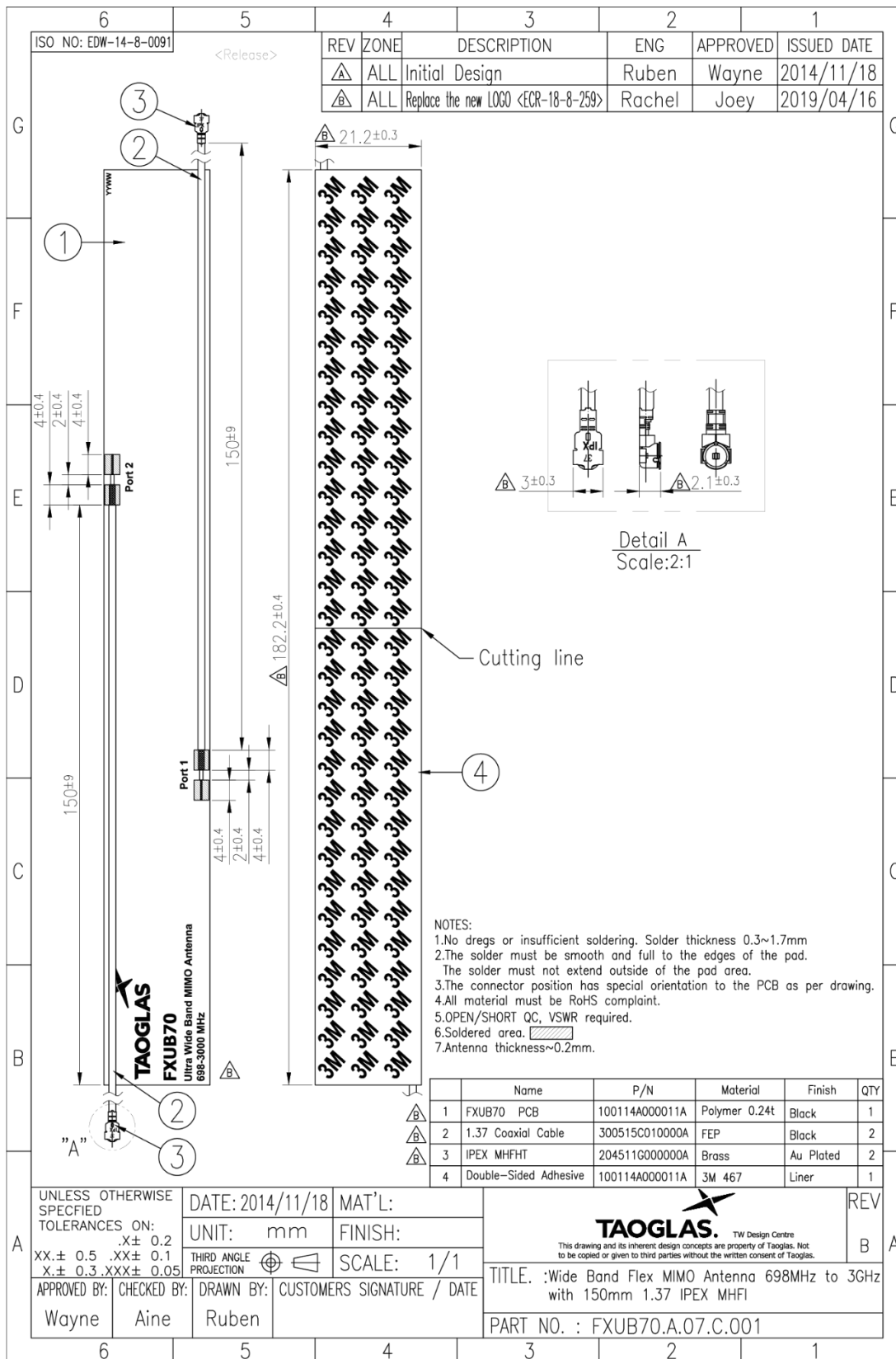

6. Packaging

50pcs FXUB70.A.07.C.001 per PE Bag
 Bag Dimensions - 300 x 160mm
 Weight - 170g

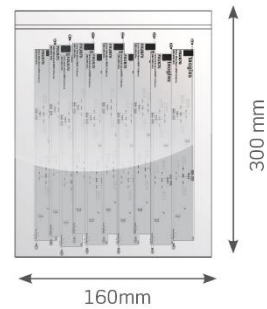

200pcs FXUB70.A.07.C.001 per Large PE Bag
 Bag Dimensions - 450 x 280mm
 Weight - 696g

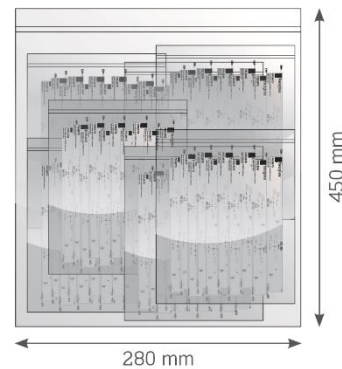

2,000 pcs FXUB70.A.07.C.001 per carton
 Carton - 330 x 250 x 230mm
 Weight - 7Kg

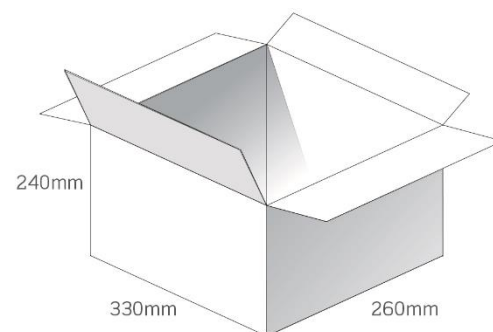

Pallet Dimensions 1200x 1000 x 1350mm
 60 Cartons per Pallet
 12 Cartons per layer
 5 Layers

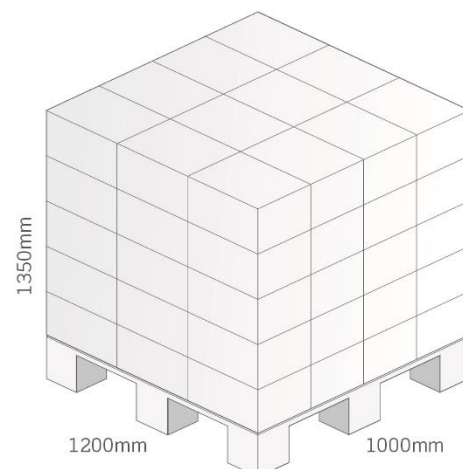

Changelog for the datasheet

SPE-14-8-056 – FXUB70.A.07.C.001

Revision: I	
Date:	2022-11-02
Notes:	Full Datasheet update
Author:	Evan Murphy

Previous Revisions

Revision: H	
Date:	2019-11-15
Notes:	Reference ECR-18-8-259
Author:	Technical Writer

Revision: C	
Date:	
Notes:	
Author:	Technical Writer

Revision: G	
Date:	2017-05-07
Notes:	
Author:	Technical Writer

Revision: B	
Date:	2014-08-25
Notes:	Changed cable routing.
Author:	Aine Doyle

Revision: F	
Date:	2017-09-06
Notes:	
Author:	Peter Monahan

Revision: A (Original First Release)	
Date:	2014-05-29
Notes:	
Author:	Technical Writer

Revision: E	
Date:	
Notes:	
Author:	Technical Writer

Revision: D	
Date:	
Notes:	
Author:	Technical Writer



www.taoglas.com

