



A Product Line of  
Diodes Incorporated



# SPECIFICATION FOR APPROVAL

CUSTOMER

NOMINAL FREQUENCY

**24.000000 MHz**

PRODUCT TYPE

**TYPE FX 6.0x3.5 SEAM SEALED CRYSTAL**

PART NUMBER

**FX2400029**

CUSTOMER P/N

ISSUE DATE

**May 14, 2018**

VERSION

**D**

APPROVED	PREPARED	QA
Brenda Kuo	Claire Cheng	Dony Yang

## Diodes Incorporated

No.2, Ziqiang 5th Rd., Zhongli Industrial Park,  
Zhongli Dist., Taoyuan City 32063, Taiwan (R.O.C.)  
TEL:886-3-451-8888  
FAX:886-3-461-3865  
<https://www.diodes.com>

\*Pb-free

\*RoHS Compliant

\*HF-Halogen Free

\*REACH Compliant

# TYPE FX 6.0x3.5 SEAM SEALED CRYSTAL

## FX2400029

VER.D 12-MAY-18

### ELECTRICAL SPECIFICATIONS

Item	Symbol	Specifications	Units	Notes
Nominal Frequency	Fn	24.000000	MHz	
Mode of Oscillation	MO	AT Cut-Fundamental		
Calibration Load Capacitance	CL	18	pF	
Calibration Tolerance	FL	$\pm 30$	ppm	at 25°C $\pm 3^{\circ}\text{C}$
Operating Temperature Range	TR	-20 to +70	°C	
Frequency Stability(Frequency Deviation over the Operating Temperature Range)	F/T	$\pm 30$	ppm	Reference to the Frequency at 25°C
Operating Drive Level		10	$\mu\text{W}$	
Equivalent Series Resistance	ESR	50	$\Omega$	Max.
Shunt Capacitance	C0	5	pF	Max.
Aging at 25°C		$\pm 3$	ppm	Max, 1st year
Storage Temperature		-55 to +125	°C	
Insulation Resistance		500	M $\Omega$	Min

\*\* This product doesn't include harmful substance that stipulated by SONY SS-00259 Level 1 and S-AT2-001 Level 1 standard. RoHS Compliant (Pb - Free).

# TYPE FX 6.0x3.5 SEAM SEALED CRYSTAL

**FX2400029**

VER.D 12-MAY-18

## RELIABILITY SPECIFICATIONS

### MECHANICAL AND ENVIRONMENTAL RATINGS:

- a) FINE LEAK TEST: JESD22-A109 (Condition 1A)
- b) GROSS LEAK TEST: JESD22-A109 (Condition C)
- c) MOISTURE RESISTANCE: JESD22-A113
- d) SHOCK: JESD22-B104 (Condition B)
- e) SOLDERABILITY : (RoHS version): J-STD-002
- f) VIBRATION: JESD22-B103
- g) SOLVENT RESISTANCE: JESD22-B107
- h) RESISTANCE TO SOLDERING HEAT (RoHS version): J-STD-020D Table 5.2 Pb free devices (3 cycles max)

## SUGGESTED IR REFLOW PROFILE

\*As per IPC-JEDEC J-STD-020D

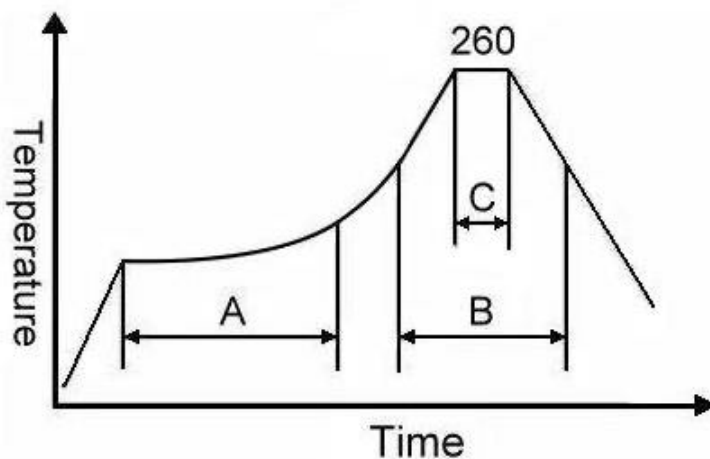

Note:

	Stage	Temperature	Time
A	Preheat	150~200°C	60~120 Sec
B	Primary Heat	217°C	60~150 Sec
C	Peak	260°C	10 Sec

# TYPE FX 6.0x3.5 SEAM SEALED CRYSTAL

**FX2400029**

VER.D 12-MAY-18

## MARKING

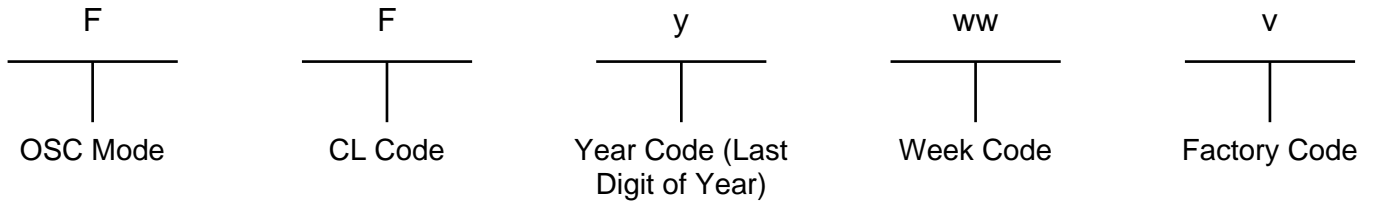
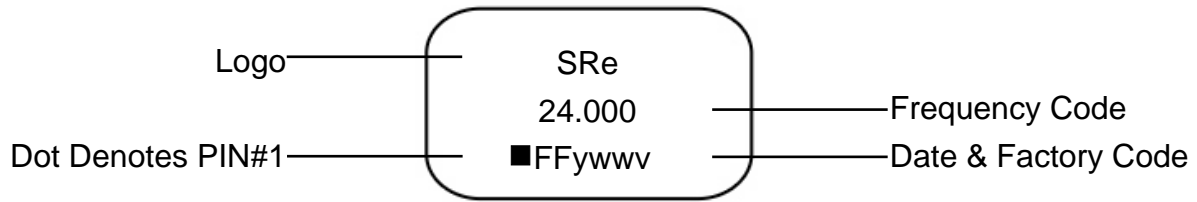

## MECHANICAL DRAWINGS ( Scale: None. Dimensions are in mm.)

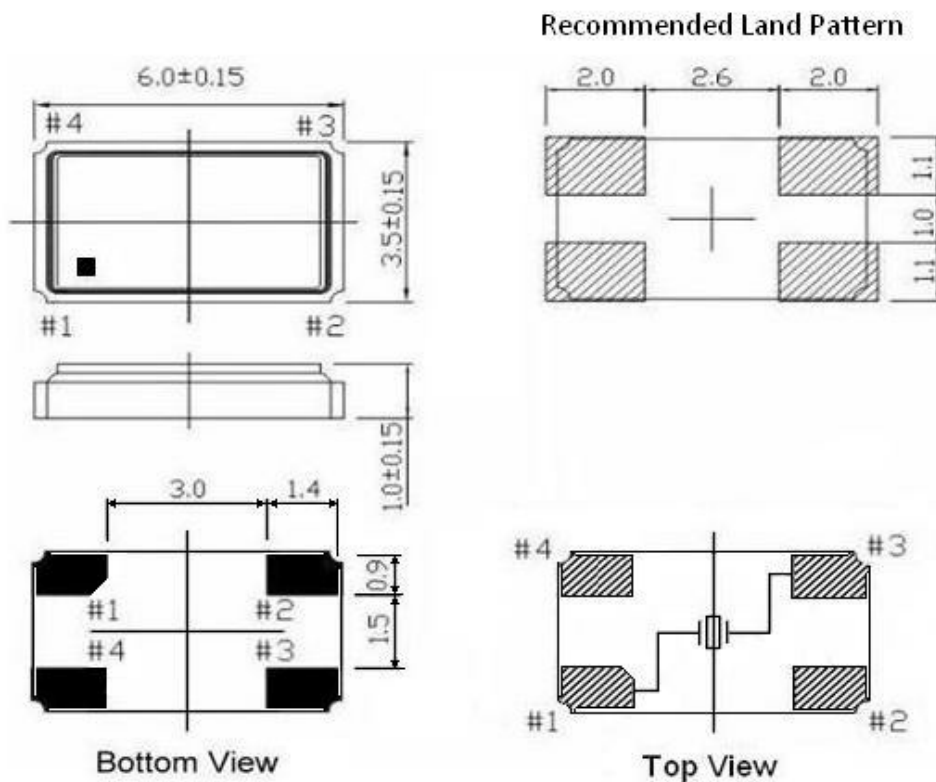

\*\* Recommended - Pin 1 & 3 : CRYSTAL  
Pin 2 & 4 : GND

### Notes:

1. Package drawings are for reference only, and the appearances of objects may vary. Actual packages are based on the real product.
2. The marking dot denotes Pin#1.
3. The position and shape of the chamfer pin may vary and are based on the real product.

# TYPE FX 6.0x3.5 SEAM SEALED CRYSTAL

**FX2400029**

VER.D 12-MAY-18

## Tape & Reel

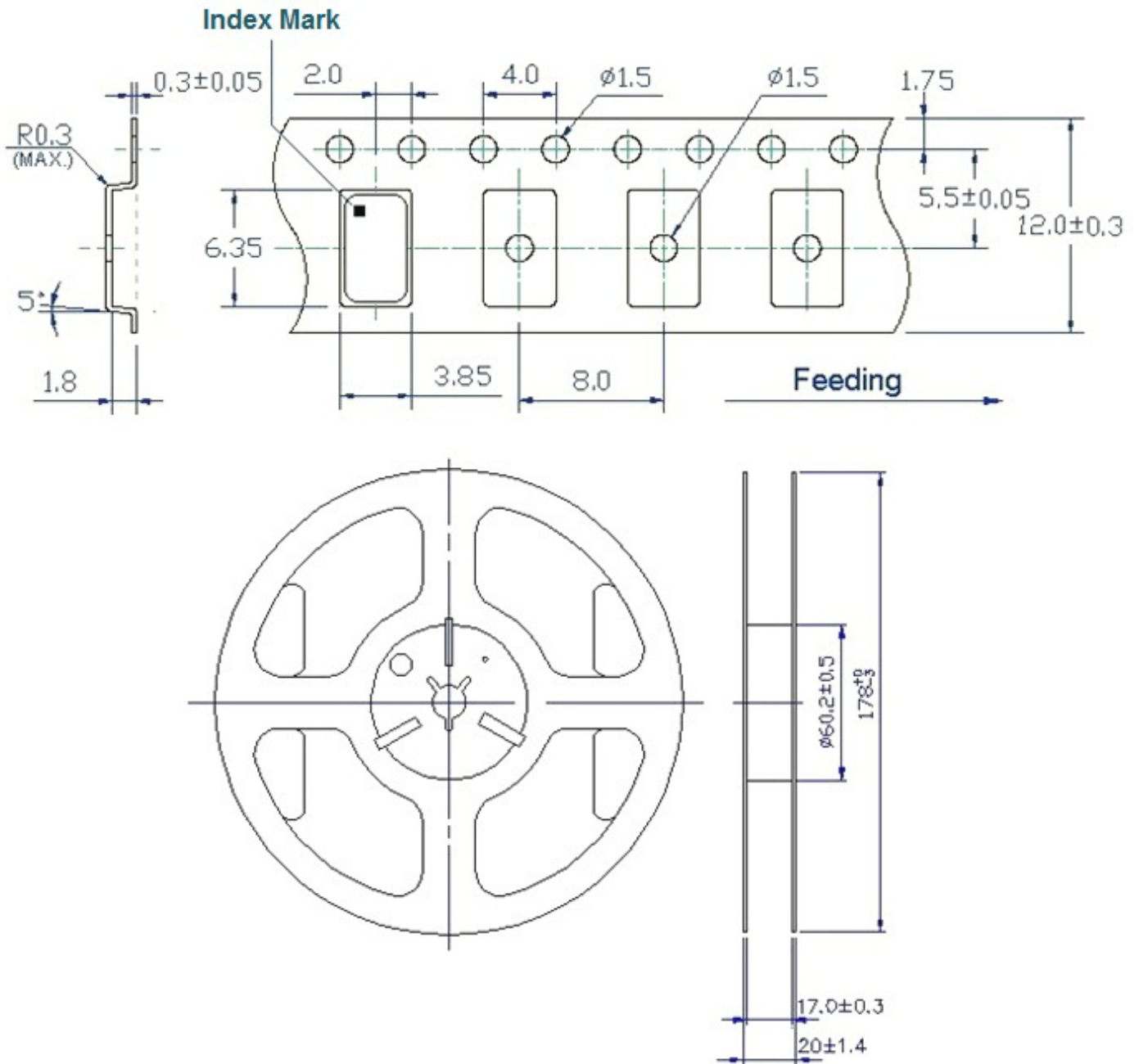

1. 230mm minimum leader which consist of carrier and/or tape followed by a minimum of 160mm of empty carrier tape sealed with cover tape.
2. 160mm minimum trailer of empty carrier tape sealed with cover tape.

# TYPE FX 6.0x3.5 SEAM SEALED CRYSTAL

FX2400029

VER.D 12-MAY-18

## PACKING

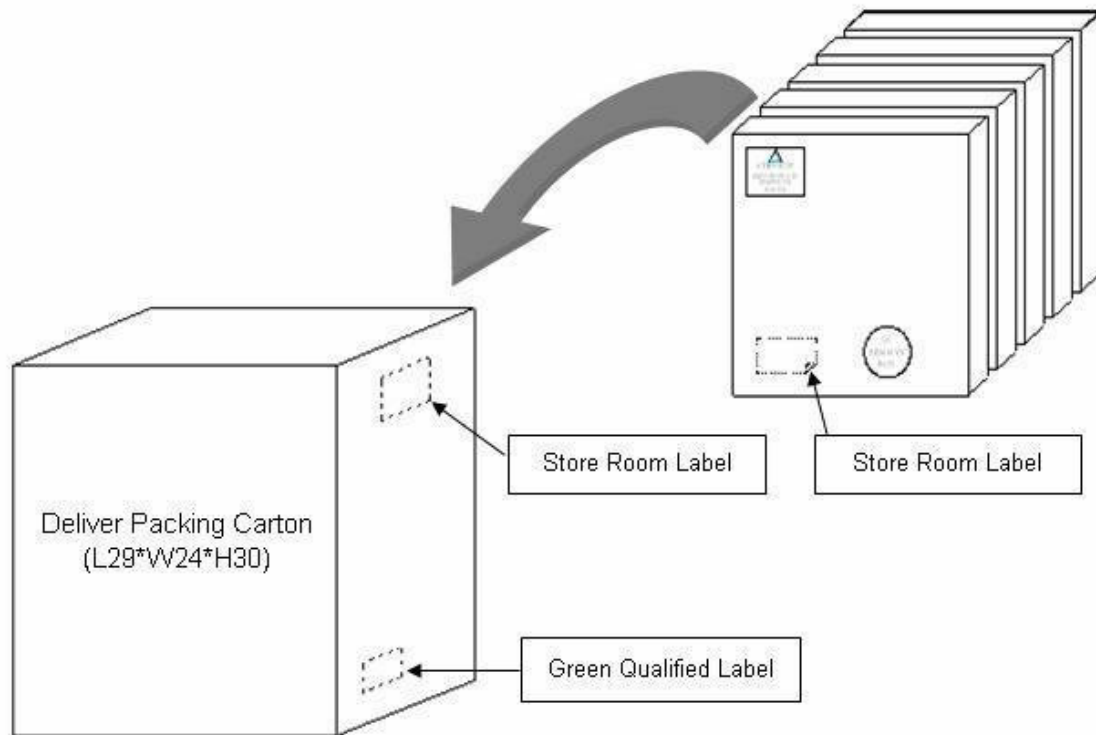
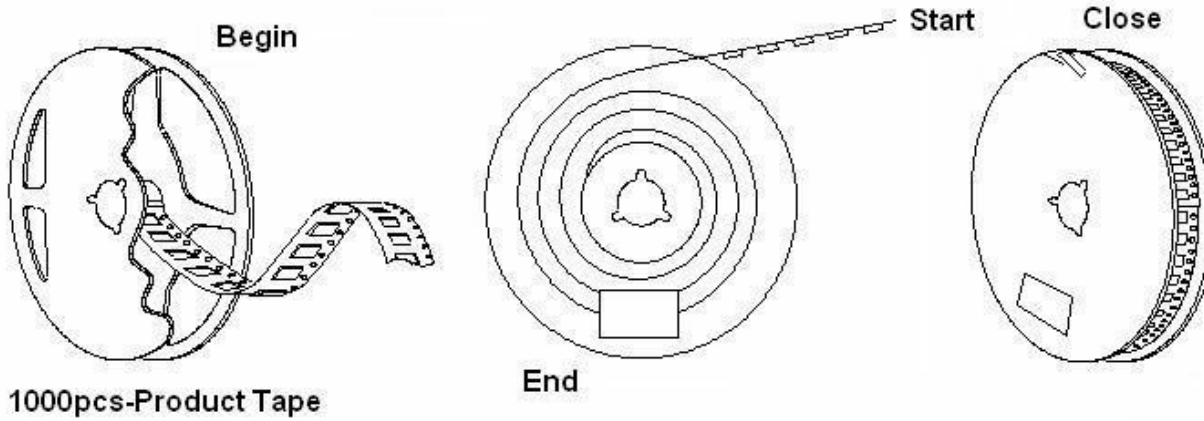

# TYPE FX 6.0x3.5 SEAM SEALED CRYSTAL

***FX2400029***

VER.D 12-MAY-18

## VERSION HISTORY

Version No.	Version Date	Description	Notes
D	May. 12, 2018	Updated Logo	