



TAOGLAS®



Datasheet

Meteor

Part No:
FW.90.SMA.M

Description:

Cellular 2G/3G/4G Flexible Whip Monopole Antenna

Features:

- Covers most Worldwide 4G/3G Cellular bands from 698-3500MHz
- Also Covers CAT-M/NB-IoT Bands
- Robust Inner Steel Core
- SMA Male Connector
- IP65 Rated Waterproof
- RoHS & Reach Compliant

1. Introduction	3
2. Specifications	4
3. Antenna Characteristics	6
4. Radiation Patterns	8
5. Mechanical Drawing	14
6. Packaging	15
<hr/>	
Changelog	16

Taoglas makes no warranties based on the accuracy or completeness of the contents of this document and reserves the right to make changes to specifications and product descriptions at any time without notice. Taoglas reserves all rights to this document and the information contained herein. Reproduction, use or disclosure to third parties without express permission is strictly prohibited.



1. Introduction



The FW.90 is a flexible cellular whip antenna with IP65 housing. It has a wide response and high peak gain. Ideal for outdoor environments which require high gain, on both lower and upper bands. It's unique characteristic is it has stable peak gain on across common cellular bands used worldwide.

Typical Applications include:

- Smart Metering
- Remote Pipeline Monitoring
- Transportation

The FW.90 can be used with a Wall Mounting Bracket, and we have designed an L Shaped Bracket for use with the Whip Antenna, the part number for this option is WM.90.A.305111. Testing of the whip antenna on the bracket, in free-space, and on a reference ground-plane has been done to show the benefit of the L-bracket.

This antenna delivers wider coverage areas and more reliable connections for professional customers in the automotive, industrial industries. The whip is made up of a flexible inner steel core covered by TPU so extremely resistant to collisions and maintaining its original shape and RF performance. The whip and the connection internally to the bracket is IP65 waterproof.

The FW.90's connector can be customized subject to NRE, for further information please contact your regional Taoglas customer support team.

2. Specifications

Electrical							
Frequency (MHz)	698~896	880~960	1710~1880	1850~1990	1710~2170	2570~2690	3300~3500
Peak Gain (dBi)							
Free Space	-1.7	-0.3	2.5	3.4	2.8	3.5	2.1
With Ground plane(30x30cm)	-1.7	2	4.7	5.1	4.6	4.7	4.3
L - Bracket	0.7	1.8	1.8	2.2	2.2	1.8	0.5
Average Gain (dB)							
Free Space	-5.8	-4.6	-1.9	-1.5	-1.7	-2.1	-3.4
With Ground plane(30x30cm)	-5.2	-3	-1.7	-1.4	-1.7	-1.8	-1.4
L - Bracket	-4	-2.4	-2.7	-3	-2.8	-2.9	-5.7
Efficiency							
Free Space	26.4	35.1	65.4	70.8	67.3	61.6	46
With Ground plane(30x30cm)	30.8	50.3	67.3	71.8	67.9	65.5	67.2
L - Bracket	43.3	57.2	53.9	49.9	53.2	51.6	27.4
Impedance	50Ω						
Polarization	Linear						
Radiation Pattern	Omni						
Input Power	50 W						
Tested Power	10 W						
Mechanical							
Height	255mm						
Base Diameter	16mm						
Whip Diameter	4mm						
Casing	ABS						
Connector	SMA Male						
Environmental							
Temperature Range	-40°C to 85°C						
Humidity	Non-condensing 65°C 95% RH						

5G/4G Bands			
Band Number	5G NR / FR1 / LTE / LTE-Advanced / WCDMA / HSPA / HSPA+ / TD-SCDMA		
	Uplink	Downlink	Covered
1	UL: 1920 to 1980	DL: 2110 to 2170	✓
2	UL: 1850 to 1910	DL: 1930 to 1990	✓
3	UL: 1710 to 1785	DL: 1805 to 1880	✓
4	UL: 1710 to 1755	DL: 2110 to 2155	✓
5	UL: 824 to 849	DL: 869 to 894	✓
7	UL: 2500 to 2570	DL: 2620 to 2690	✓
8	UL: 880 to 915	DL: 925 to 960	✓
9	UL: 1749.9 to 1784.9	DL: 1844.9 to 1879.9	✓
11	UL: 1427.9 to 1447.9	DL: 1475.9 to 1495.9	✗
12	UL: 699 to 716	DL: 729 to 746	✓
13	UL: 777 to 787	DL: 746 to 756	✓
14	UL: 788 to 798	DL: 758 to 768	✓
17	UL: 704 to 716	DL: 734 to 746	✓
18	UL: 815 to 830	DL: 860 to 875	✓
19	UL: 830 to 845	DL: 875 to 890	✓
20	UL: 832 to 862	DL: 791 to 821	✓
21	UL: 1447.9 to 1462.9	DL: 1495.9 to 1510.9	✗
22	UL: 3410 to 3490	DL: 3510 to 3590	✓
23	UL: 2000 to 2020	DL: 2180 to 2200	✓
24	UL: 1625.5 to 1660.5	DL: 1525 to 1559	✗
25	UL: 1850 to 1915	DL: 1930 to 1995	✓
26	UL: 814 to 849	DL: 859 to 894	✓
27	UL: 807 to 824	DL: 852 to 869	✓
28	UL: 703 to 748	DL: 758 to 803	✓
29	UL: -	DL: 717 to 728	✓
30	UL: 2305 to 2315	DL: 2350 to 2360	✓
31	UL: 452.5 to 457.5	DL: 462.5 to 467.5	✗
32	UL: -	DL: 1452 – 1496	✗
35		1850 to 1910	✓
38		2570 to 2620	✓
39		1880 to 1920	✓
40		2300 to 2400	✓
41		2496 to 2690	✓
42		3400 to 3600	✓
43		3600 to 3800	✗
48		3550 to 3700	✗
66	UL: 1710-1780	DL: 2110-2200	✓
71		617 to 698	✗
74/75/76		1427 to 1518	✗
77		3300 to 4200	✗
78		3300 to 3800	✓
79		4400 to 5000	✗

3. Antenna Characteristics

3.1 Return Loss

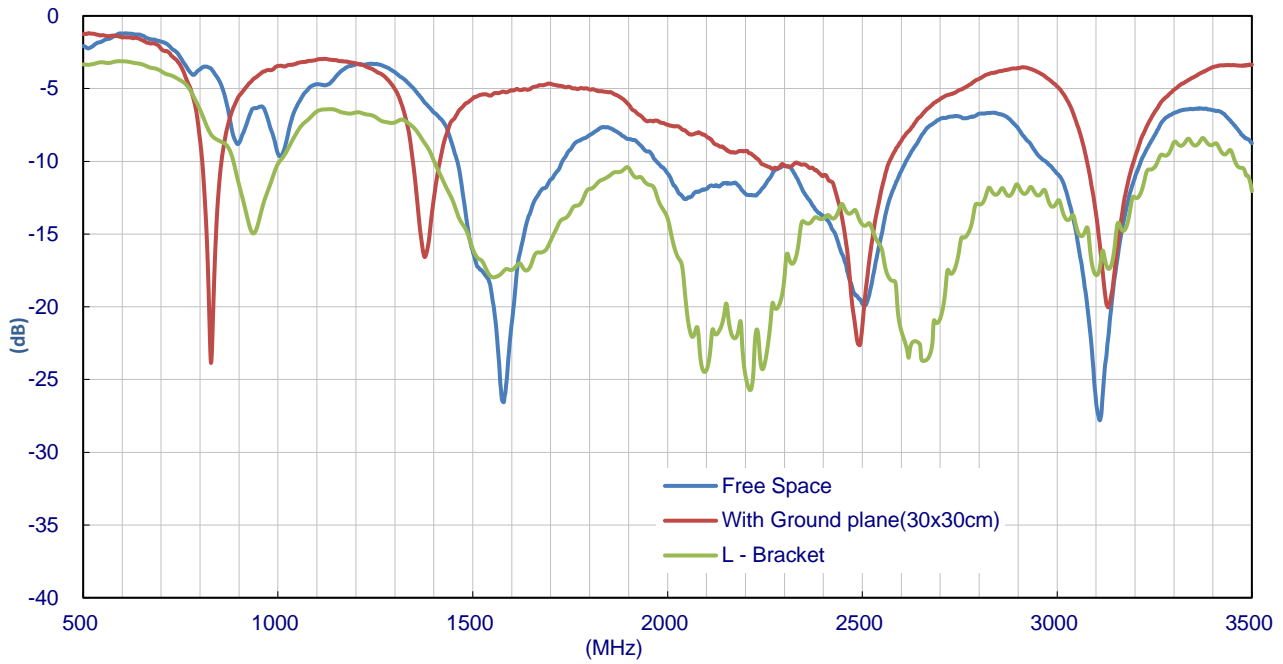

3.2 Efficiency

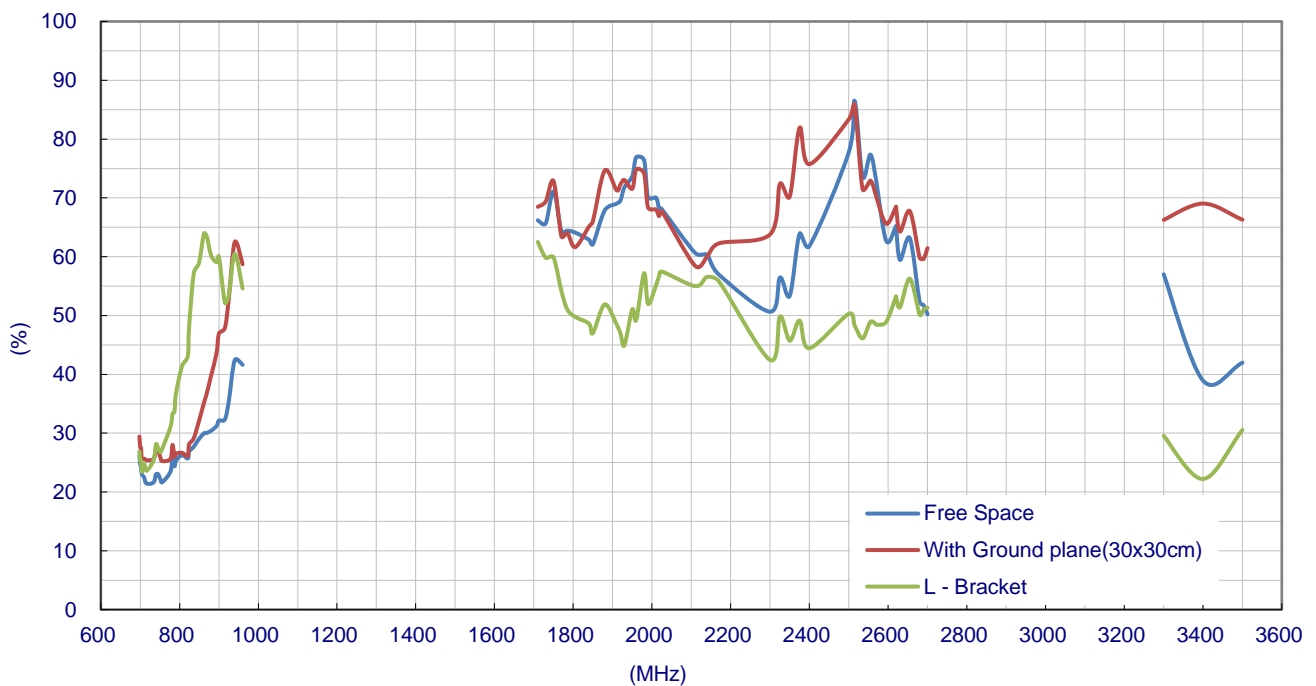

3.3 Peak Gain



3.4 Average Gain

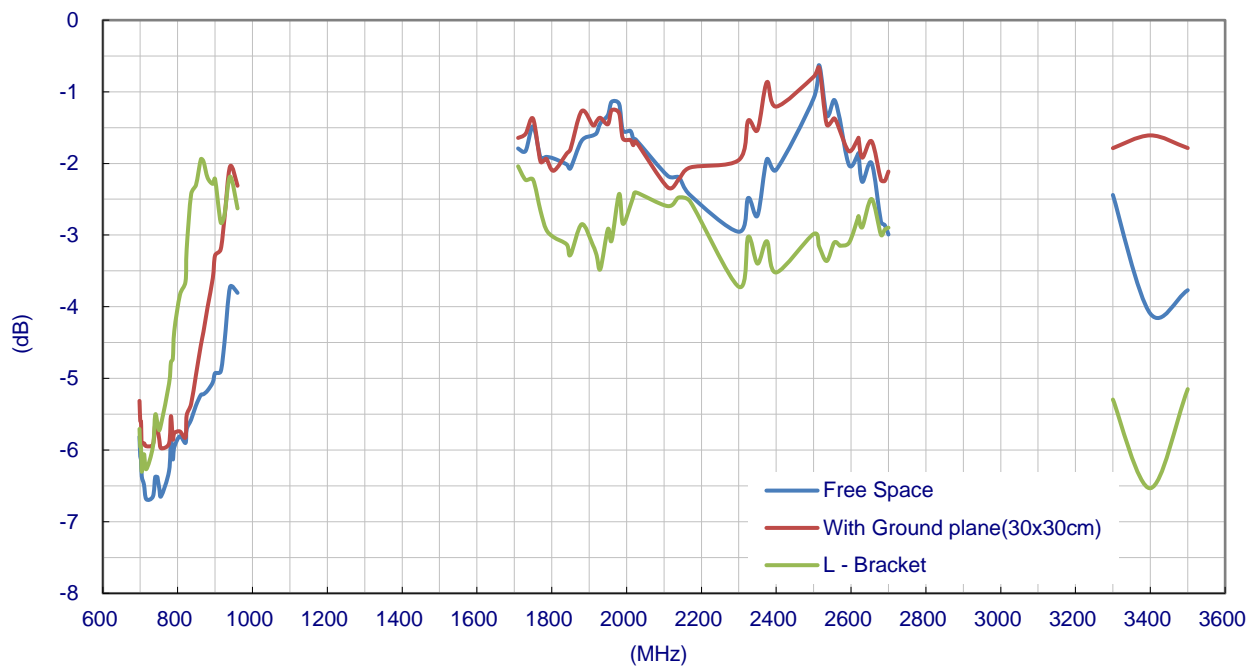

4. Radiation Patterns

4.1 Antenna Stand Alone

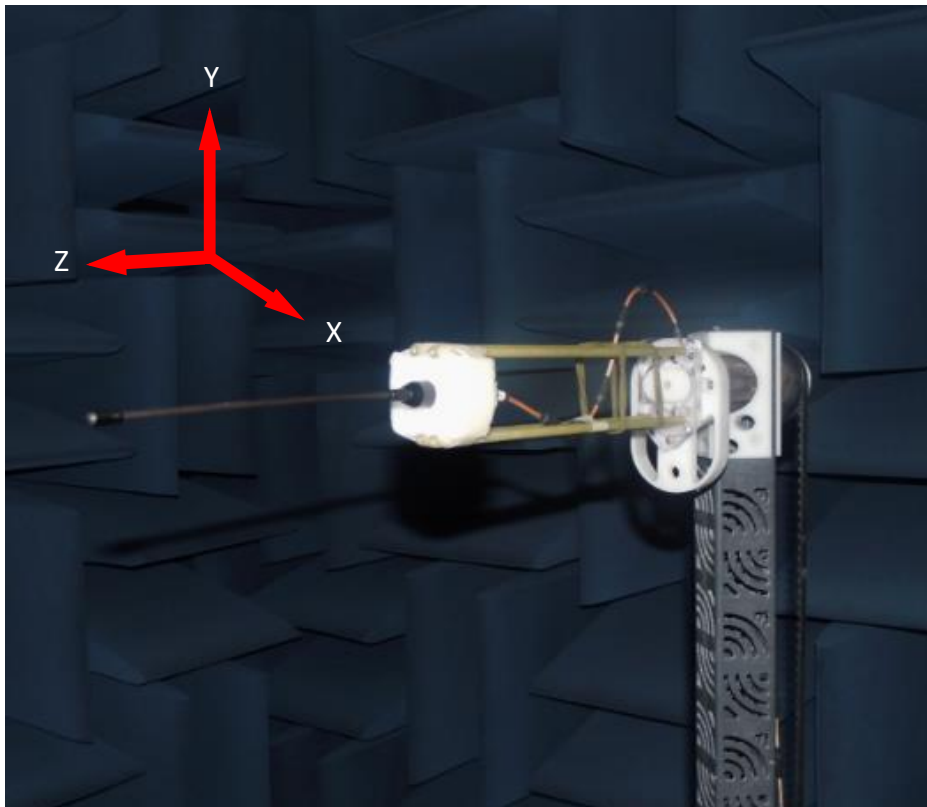

XY Plane

XZ Plane

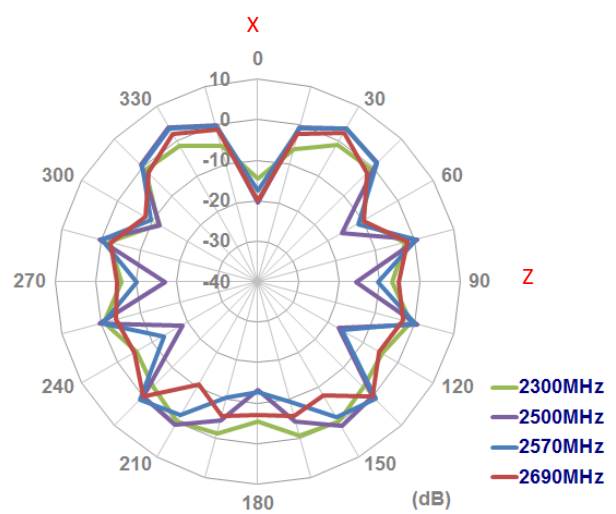
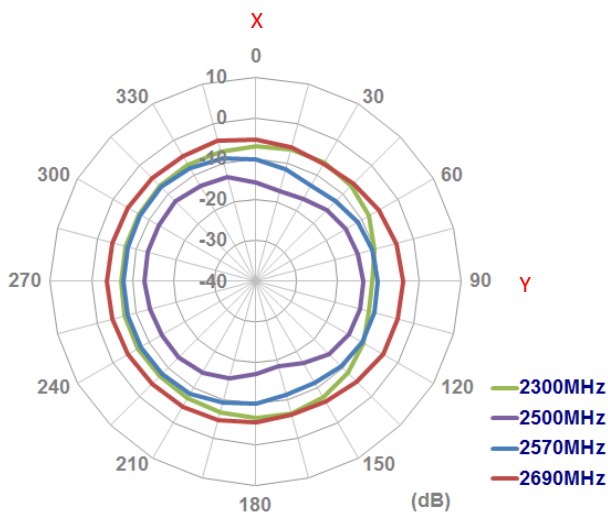
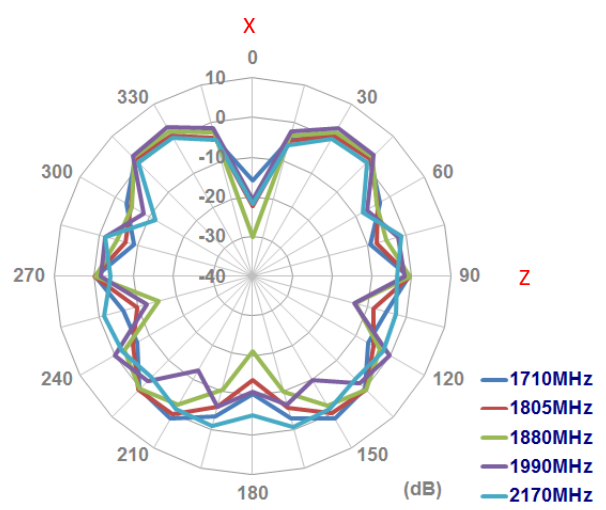
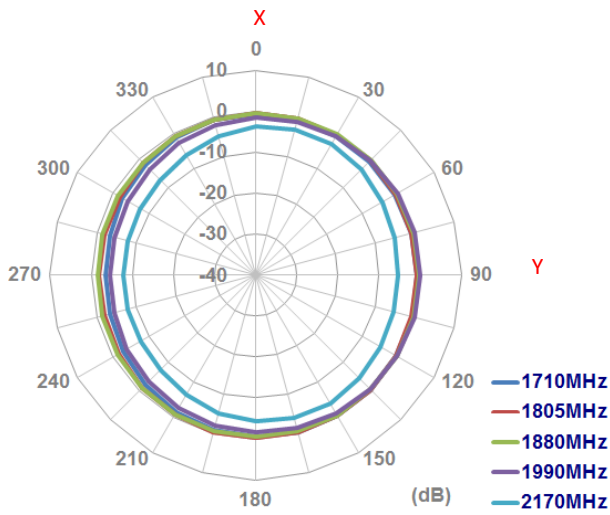
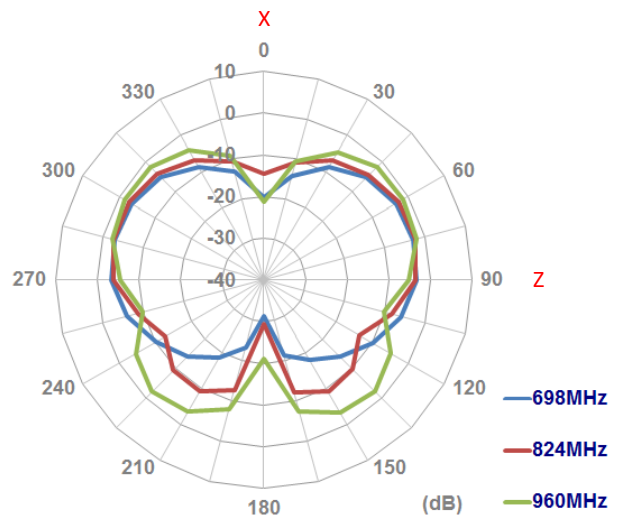
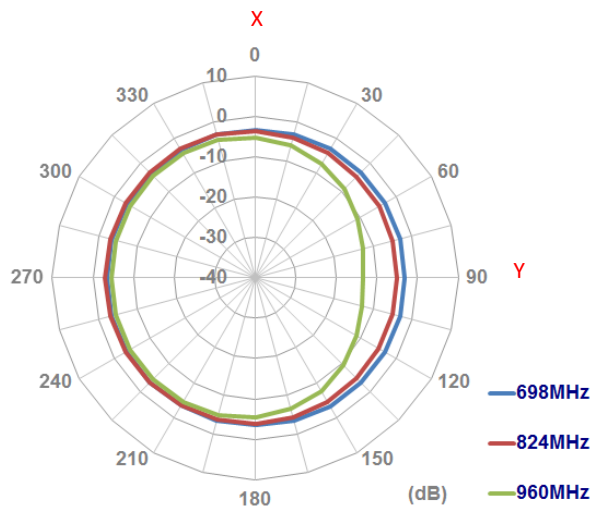

4.2 Antenna with Ground plane (30*30cm)

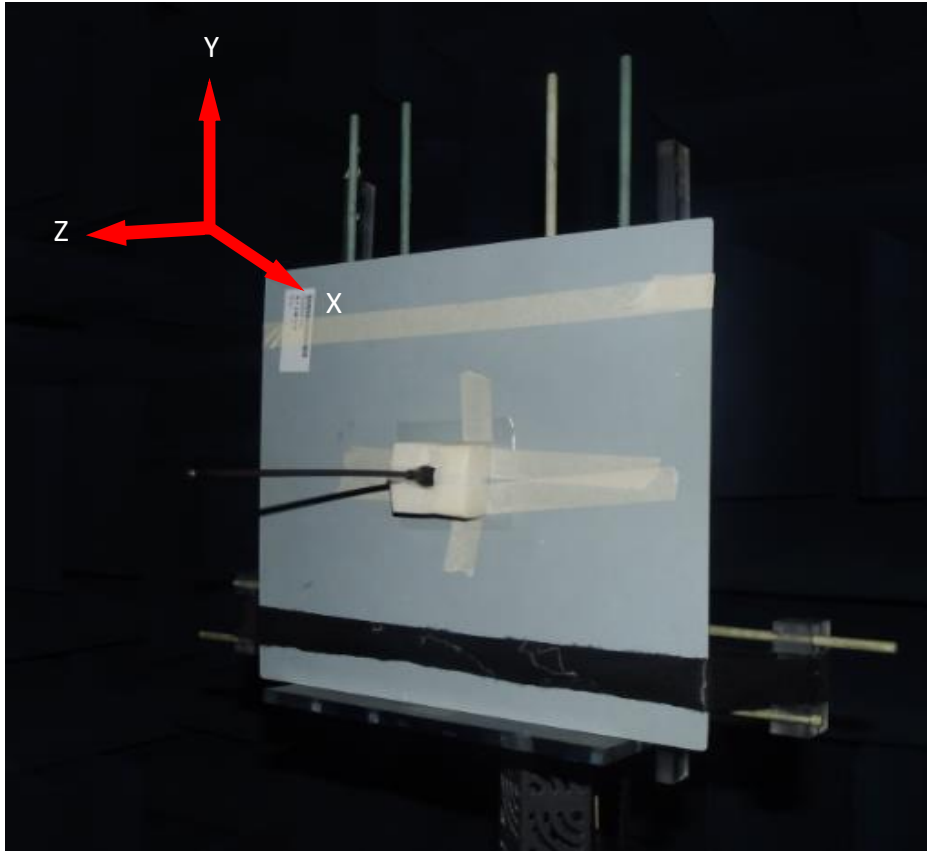

XY Plane

XZ Plane

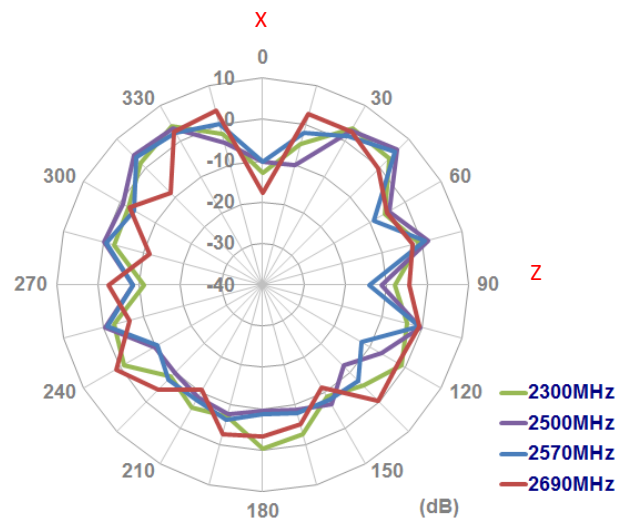
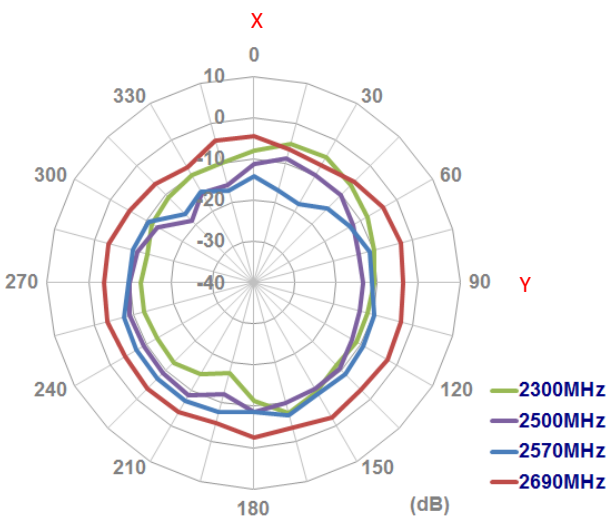
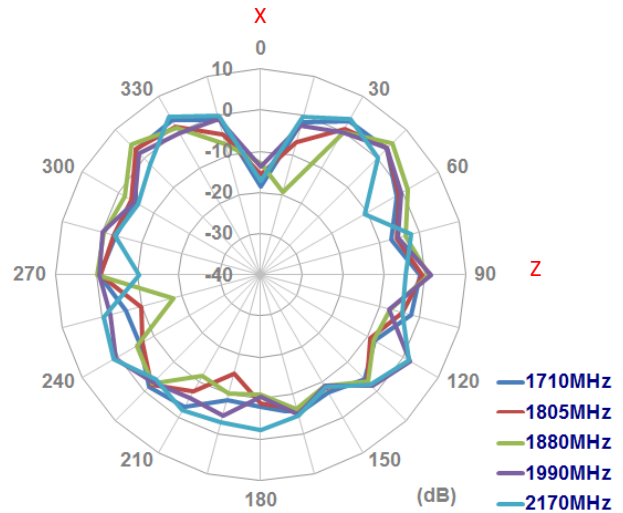
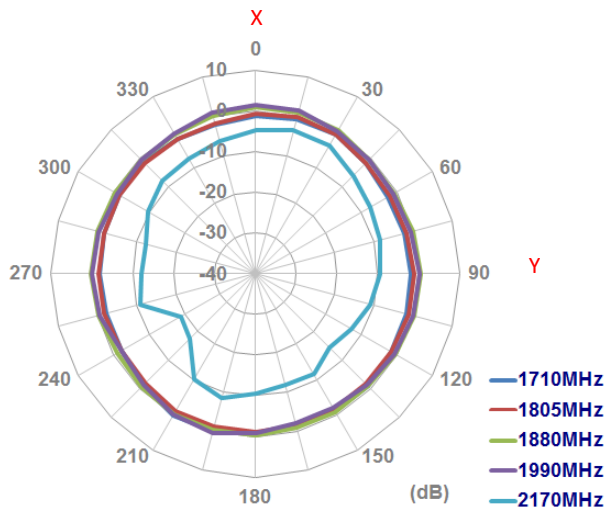
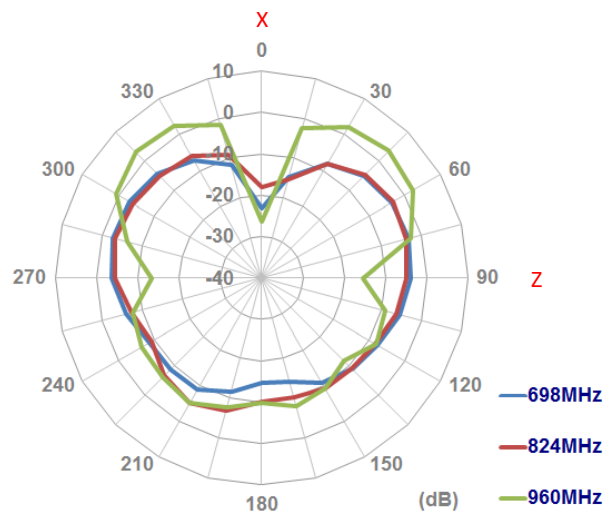
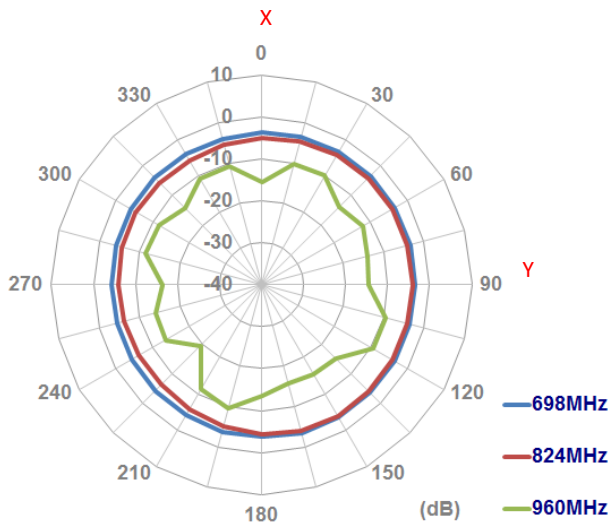

4.3 Antenna with L-Bracket

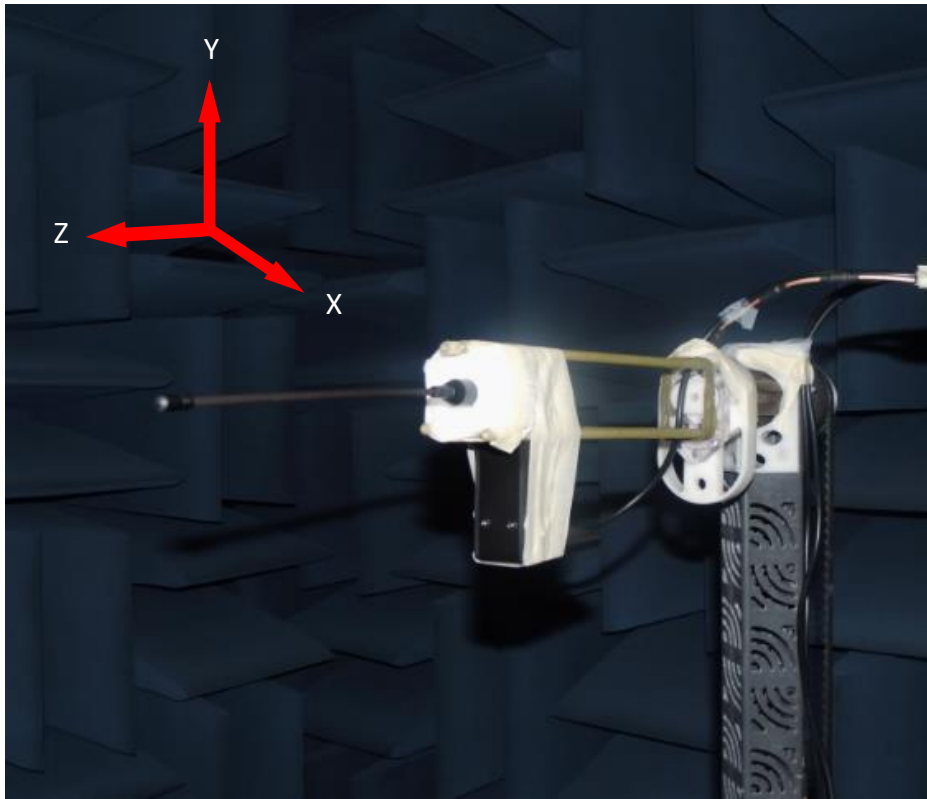

XY Plane

XZ Plane

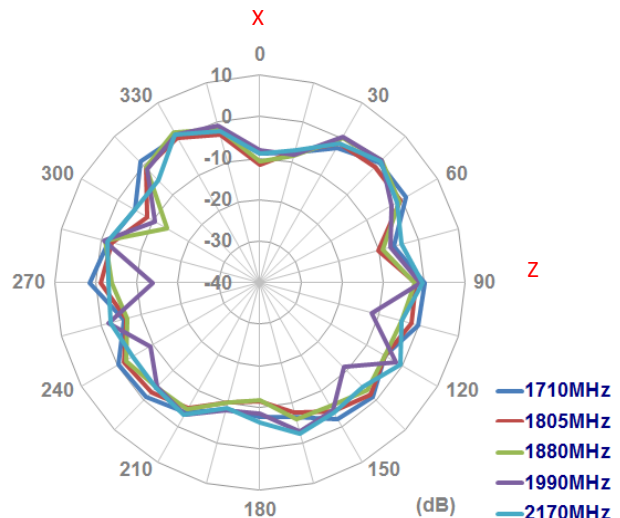
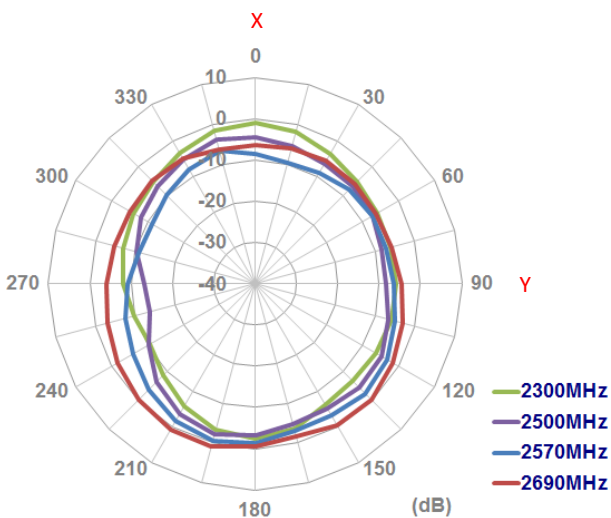
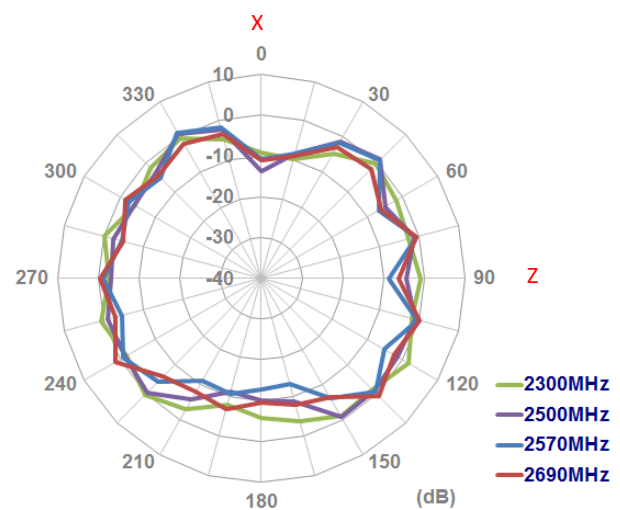
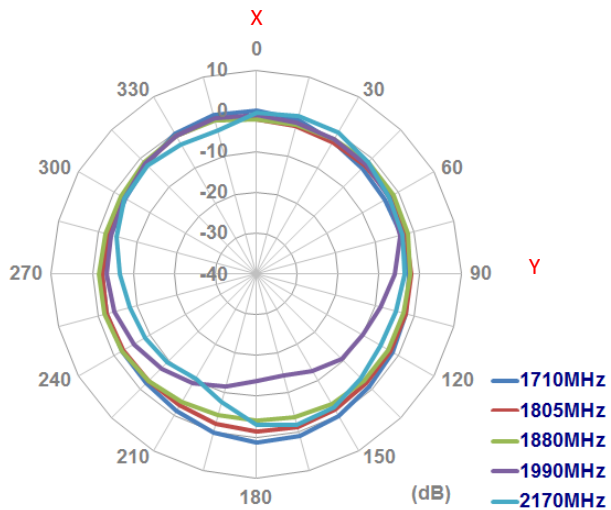
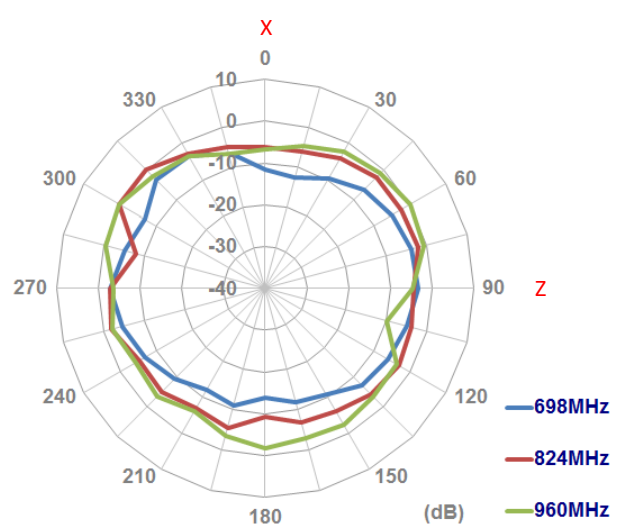
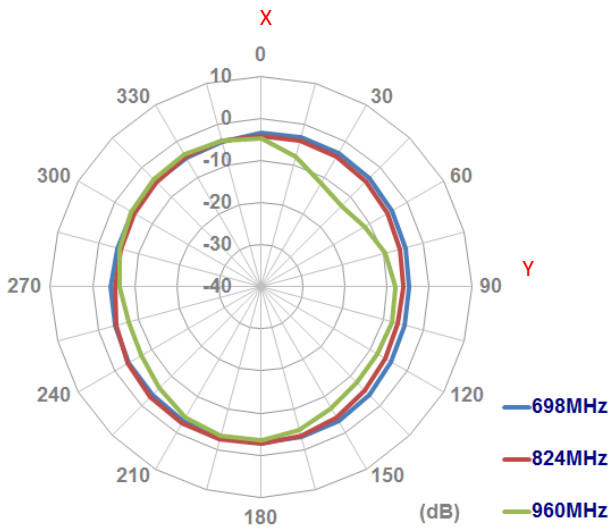

5. Mechanical Drawing (Units: mm)

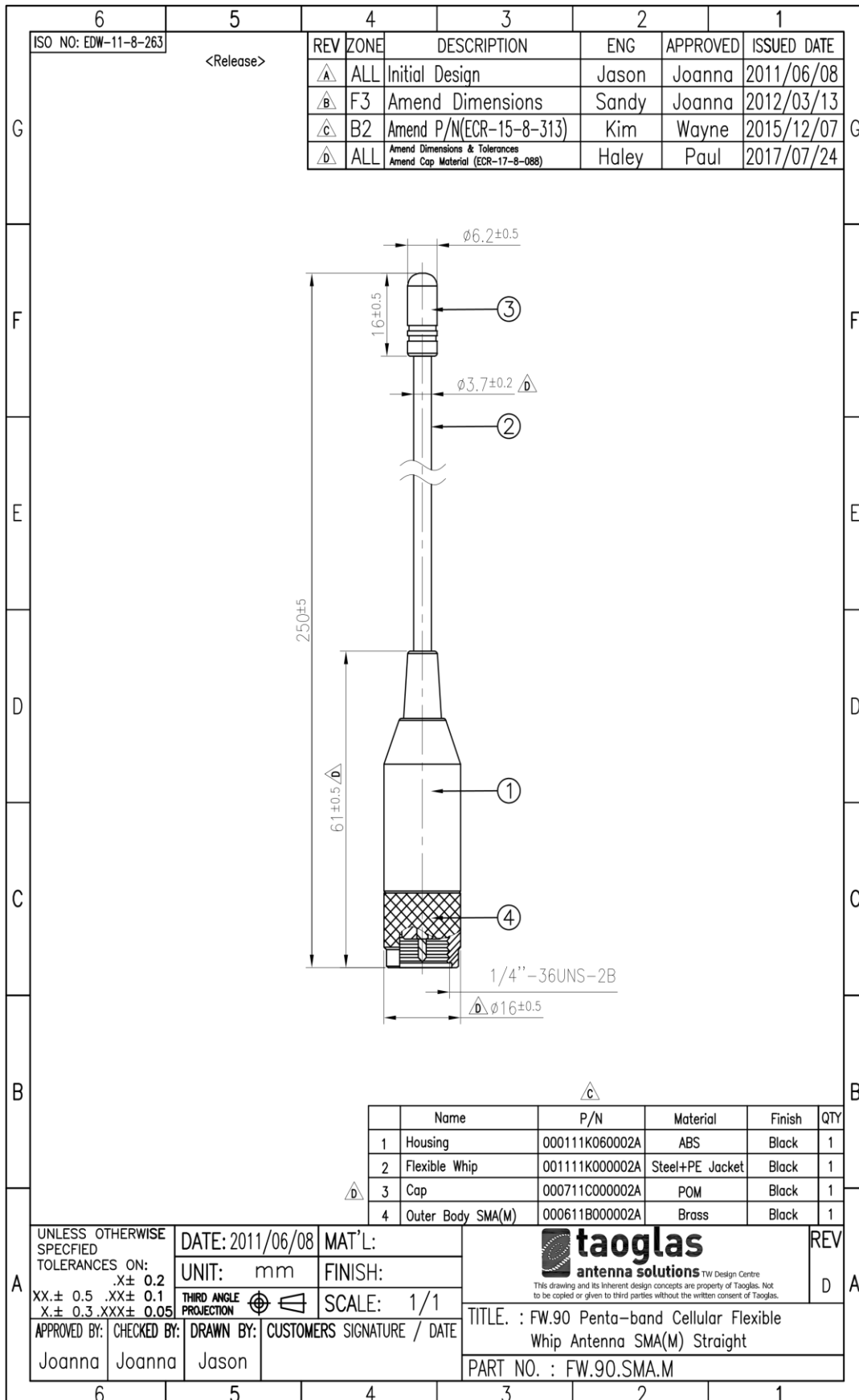

6. Packaging

1pc FW.90.SMA.M per PE Bag
 Bag Dimension: 200*100mm
 Weight: 50g

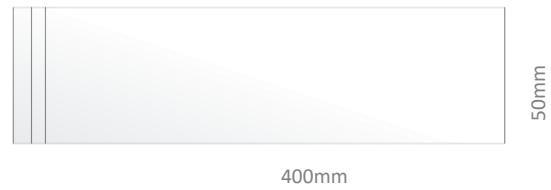

50pcs FW.90.SMA.M per Large PE Bag
 Bag Dimensions: 520*360mm
 Weight: 2.5Kg



200pcs FW.90.SMA.M per Carton
 Dimensions: 360*310*160mm
 Weight: 10.2Kg

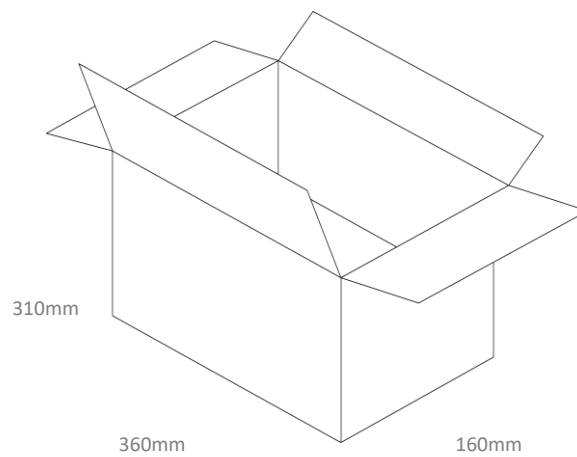

Changelog for the datasheet

SPE-11-8-142 - FW.90.SMA.M

Revision: K (Current Version)

Date:	2020-03-20
Changes:	Updated to show new data
Changes Made by:	Jack Conroy

Previous Revisions

Revision: J

Date:	2019-08-16
Changes:	Updated to new format
Changes Made by:	Dan Cantwell

Revision: E

Date:	2014-03-21
Changes:	Updated spec to include 698~798MHz and also for 2570~2690Mhz
Changes Made by:	Aine Doyle

Revision: I

Date:	2017-08-04
Changes:	Updated as per PCN-17-8-026
Changes Made by:	Andy Mahoney

Revision: D

Date:	2012-07-08
Changes:	
Changes Made by:	

Revision: H

Date:	2017-05-02
Changes:	Update as per PCN
Changes Made by:	Andy Mahoney

Revision: C

Date:	2012-03-23
Changes:	Packaging Details Updated
Changes Made by:	Made by Andy Mahoney

Revision: G

Date:	2017-04-04
Changes:	Added LTE Band Table
Changes Made by:	Peter Monahan

Revision: B

Date:	2012-02-27
Changes:	
Changes Made by:	

Revision: F

Date:	2014-06-08
Changes:	Retested
Changes Made by:	Aine Doyle

Revision: A (Original First Release)

Date:	2011-11-22
Notes:	
Author:	Wayne Yang



TAOGLAS®

www.taoglas.com

