

# FMG2G200US60

## Molding Type Module

### General Description

Fairchild IGBT Power Module provides low conduction and switching losses as well as short circuit ruggedness. It's designed for the applications such as motor control, uninterrupted power supplies (UPS) and general inverters where short-circuit ruggedness is required.

### Features

- Short Circuit Rated Time; 10us @  $T_C = 100^\circ\text{C}$ ,  $V_{GE} = 15\text{V}$
- High Speed Switching
- Low Saturation Voltage :  $V_{CE(sat)} = 2.1\text{V}$  @  $I_C = 200\text{A}$
- High Input Impedance
- Fast & Soft Anti-Parallel FWD
- UL Certified No.E209204

### Application

- AC & DC Motor Controls
- General Purpose Inverters
- Robotics
- Servo Controls
- UPS

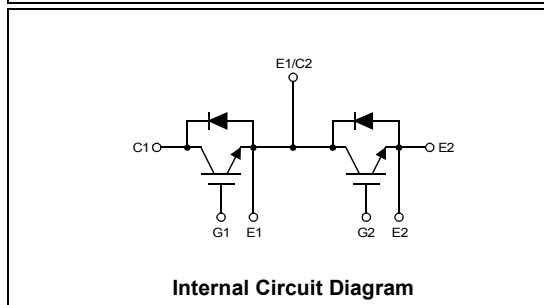
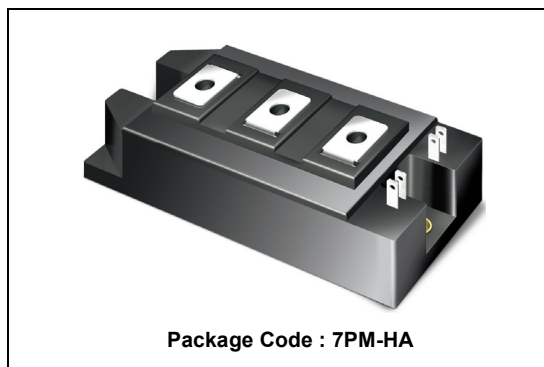

### Absolute Maximum Ratings $T_C = 25^\circ\text{C}$ unless otherwise noted

Symbol	Description	FMG2G200US60	Units
$V_{CES}$	Collector-Emitter Voltage	600	V
$V_{GES}$	Gate-Emitter Voltage	$\pm 20$	V
$I_C$	Collector Current @ $T_C = 80^\circ\text{C}$	200	A
$I_{CM(1)}$	Pulsed Collector Current	400	A
$I_F$	Diode Continuous Forward Current @ $T_C = 80^\circ\text{C}$	200	A
$I_{FM}$	Diode Maximum Forward Current	400	A
$P_D$	Maximum Power Dissipation @ $T_C = 25^\circ\text{C}$	695	W
$T_{SC}$	Short Circuit Withstand Time @ $T_C = 100^\circ\text{C}$	10	us
$T_J$	Operating Junction Temperature	-40 to +150	$^\circ\text{C}$
$T_{STG}$	Storage Temperature Range	-40 to +125	$^\circ\text{C}$
$V_{ISO}$	Isolation Voltage @ AC 1minute	2500	V
Mounting Torque	Power Terminal Screw : M5	4.0	N.m
	Mounting Screw : M6	4.0	N.m

**Notes :**

(1) Repetitive rating : Pulse width limited by max. junction temperature

### Electrical Characteristics of IGBT T<sub>C</sub> = 25°C unless otherwise noted

Symbol	Parameter	Test Conditions	Min.	Typ.	Max.	Units
<b>Off Characteristics</b>						
BV <sub>CES</sub>	Collector-Emitter Breakdown Voltage	V <sub>GE</sub> = 0V, I <sub>C</sub> = 250uA	600	--	--	V
ΔBV <sub>CES</sub> /ΔT <sub>J</sub>	Temperature Coeff. of Breakdown Voltage	V <sub>GE</sub> = 0V, I <sub>C</sub> = 1mA	--	0.6	--	V/°C
I <sub>CES</sub>	Collector Cut-Off Current	V <sub>CE</sub> = V <sub>CES</sub> , V <sub>GE</sub> = 0V	--	--	250	uA
I <sub>GES</sub>	Gate - Emitter Leakage Current	V <sub>GE</sub> = V <sub>GES</sub> , V <sub>CE</sub> = 0V	--	--	± 100	nA

### On Characteristics

V <sub>GE(th)</sub>	Gate - Emitter Threshold Voltage	I <sub>C</sub> = 200mA, V <sub>CE</sub> = V <sub>GE</sub>	5.0	6.5	8.5	V
V <sub>CE(sat)</sub>	Collector to Emitter Saturation Voltage	I <sub>C</sub> = 200A, V <sub>GE</sub> = 15V	--	2.1	2.7	V

### Switching Characteristics

t <sub>d(on)</sub>	Turn-On Delay Time	V <sub>CC</sub> = 300 V, I <sub>C</sub> = 200A, R <sub>G</sub> = 2Ω, V <sub>GE</sub> = 15V, Inductive Load, T <sub>C</sub> = 25°C	--	80	--	ns
t <sub>r</sub>	Rise Time		--	120	--	ns
t <sub>d(off)</sub>	Turn-Off Delay Time		--	130	--	ns
t <sub>f</sub>	Fall Time		--	130	250	ns
E <sub>on</sub>	Turn-On Switching Loss		--	2.7	--	mJ
E <sub>off</sub>	Turn-Off Switching Loss	--	6.0	--	mJ	
t <sub>d(on)</sub>	Turn-On Delay Time	V <sub>CC</sub> = 300 V, I <sub>C</sub> = 200A, R <sub>G</sub> = 2Ω, V <sub>GE</sub> = 15V, Inductive Load, T <sub>C</sub> = 125°C	--	200	--	ns
t <sub>r</sub>	Rise Time		--	130	--	ns
t <sub>d(off)</sub>	Turn-Off Delay Time		--	170	--	ns
t <sub>f</sub>	Fall Time		--	240	--	ns
E <sub>on</sub>	Turn-On Switching Loss		--	4.4	--	mJ
E <sub>off</sub>	Turn-Off Switching Loss	--	10.5	--	mJ	
T <sub>sc</sub>	Short Circuit Withstand Time	V <sub>CC</sub> = 300 V, V <sub>GE</sub> = 15V @ T <sub>C</sub> = 100°C	10	--	--	us
Q <sub>g</sub>	Total Gate Charge	V <sub>CE</sub> = 300 V, I <sub>C</sub> = 200A, V <sub>GE</sub> = 15V	--	625	--	nC
Q <sub>ge</sub>	Gate-Emitter Charge		--	150	--	nC
Q <sub>gc</sub>	Gate-Collector Charge		--	215	--	nC

### Electrical Characteristics of DIODE T<sub>C</sub> = 25°C unless otherwise noted

Symbol	Parameter	Test Conditions	Min.	Typ.	Max.	Units	
V <sub>FM</sub>	Diode Forward Voltage	I <sub>F</sub> = 200A	T <sub>C</sub> = 25°C	--	1.9	2.8	V
			T <sub>C</sub> = 100°C	--	1.8	--	
t <sub>rr</sub>	Diode Reverse Recovery Time	I <sub>F</sub> = 200A di / dt = 400 A/us	T <sub>C</sub> = 25°C	--	90	130	ns
			T <sub>C</sub> = 100°C	--	130	--	
I <sub>rr</sub>	Diode Peak Reverse Recovery Current	I <sub>F</sub> = 200A di / dt = 400 A/us	T <sub>C</sub> = 25°C	--	19	25	A
			T <sub>C</sub> = 100°C	--	25	--	
Q <sub>rr</sub>	Diode Reverse Recovery Charge	I <sub>F</sub> = 200A di / dt = 400 A/us	T <sub>C</sub> = 25°C	--	855	1600	nC
			T <sub>C</sub> = 100°C	--	1625	--	

### Thermal Characteristics

Symbol	Parameter	Typ.	Max.	Units
R <sub>θJC</sub>	Junction-to-Case (IGBT Part, per 1/2 Module)	--	0.18	°C/W
R <sub>θJC</sub>	Junction-to-Case (DIODE Part, per 1/2 Module)	--	0.37	°C/W
R <sub>θJC</sub>	Case-to-Sink (Conductive grease applied)	0.04	--	°C/W
Weight	Weight of Module	240	--	g

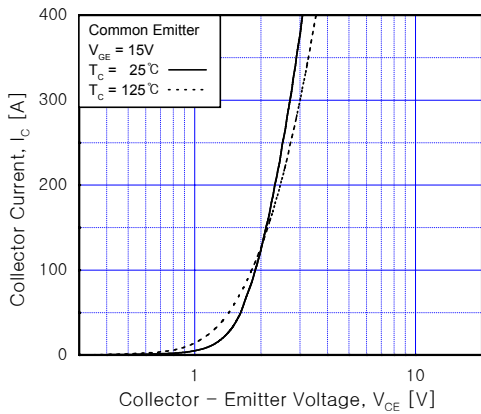

Fig 1. Typical Output Characteristics

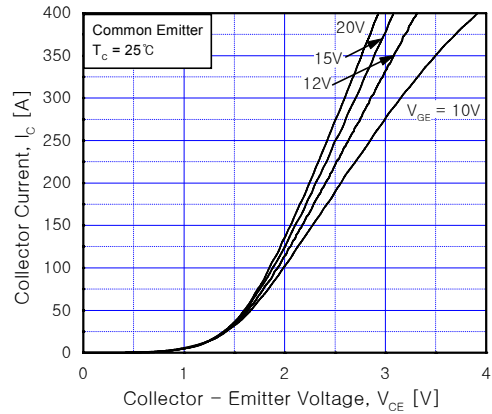

Fig 2. Typical Saturation Voltage Characteristics

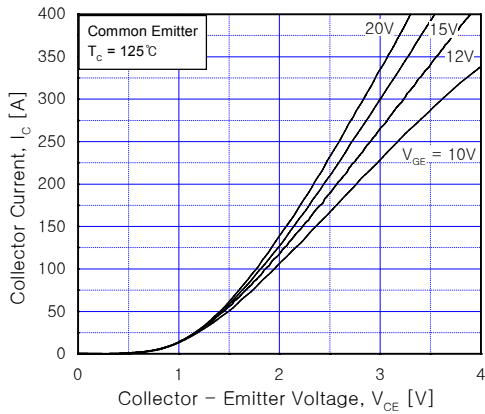

Fig 3. Typical Saturation Voltage Characteristics

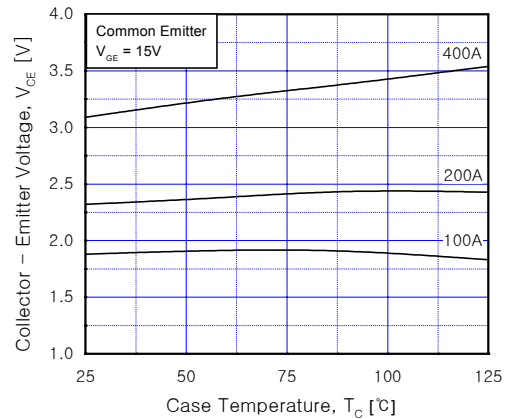

Fig 4. Saturation Voltage vs. Case Temperature at Variant Current Level

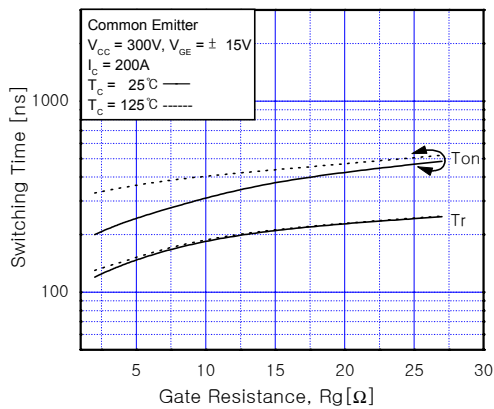

Fig 5. Turn-On Characteristics vs. Gate Resistance

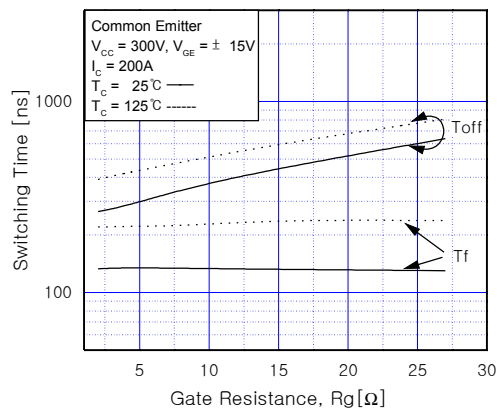

Fig 6. Turn-Off Characteristics vs. Gate Resistance

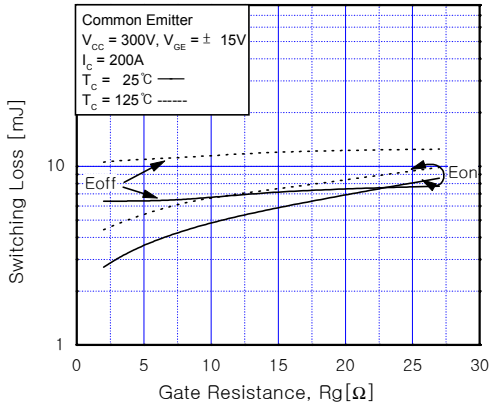

Fig 7. Switching Loss vs. Gate Resistance

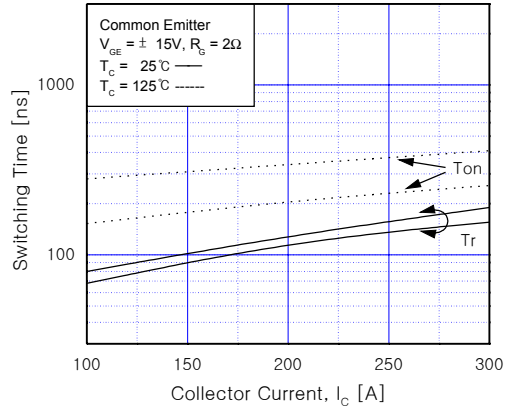

Fig 8. Turn-On Characteristics vs. Collector Current

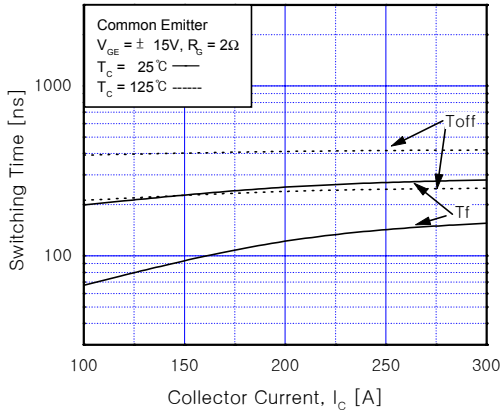

Fig 9. Turn-Off Characteristics vs. Collector Current

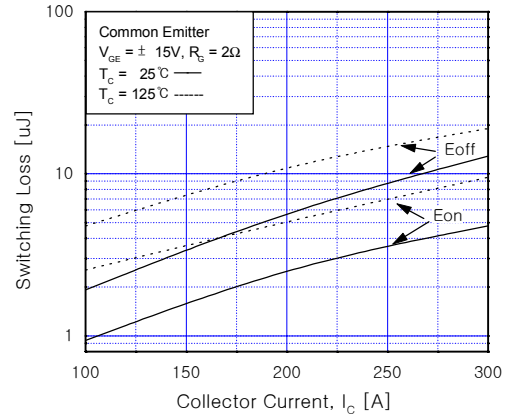

Fig 10. Switching Loss vs. Collector Current

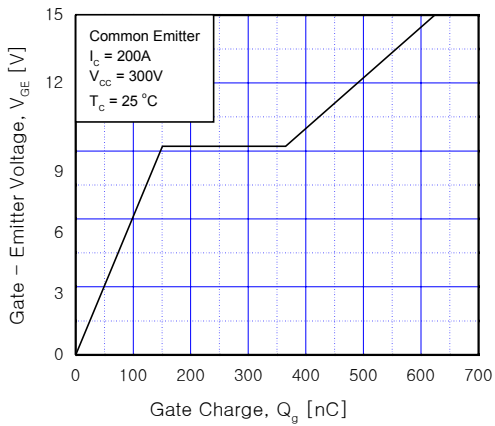

Fig 11. Gate Charge Characteristics

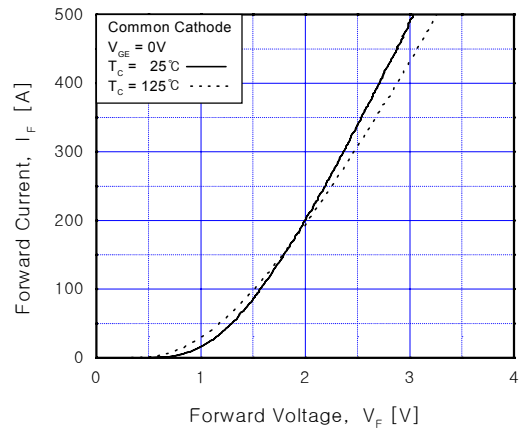

Fig 12. Forward Characteristics (diode)

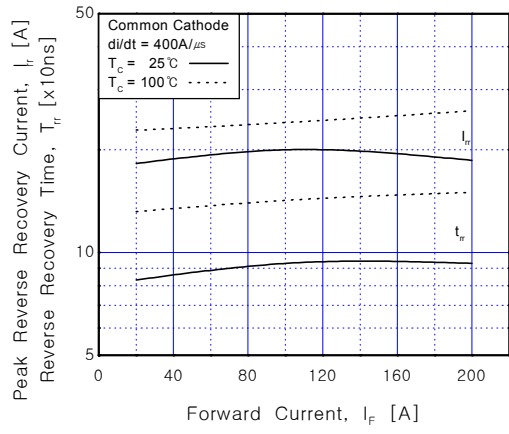
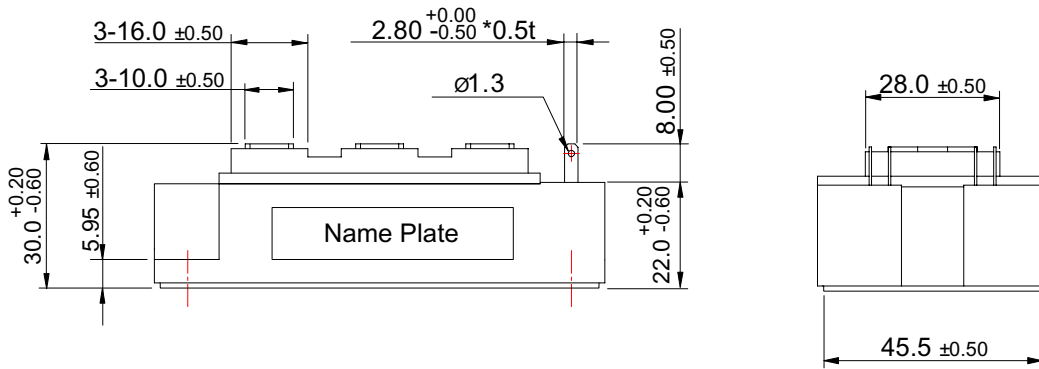
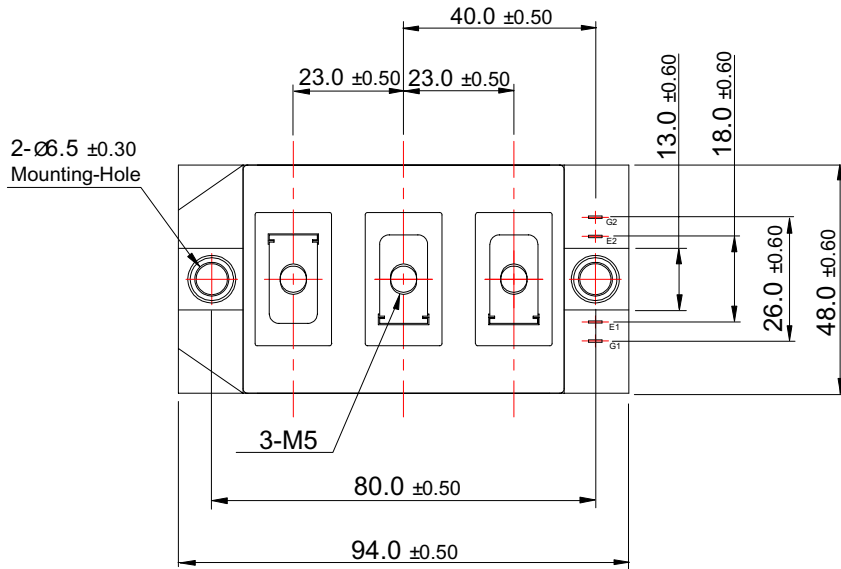

Fig 13. Reverse Recovery Characteristics(diode)

Package Dimension

7PM-HA



Dimensions in Millimeters

## TRADEMARKS

The following are registered and unregistered trademarks Fairchild Semiconductor owns or is authorized to use and is not intended to be an exhaustive list of all such trademarks.

ACE <sup>x</sup> <sup>™</sup>	FACT <sup>™</sup>	ImpliedDisconnect <sup>™</sup>	PACMAN <sup>™</sup>	SPM <sup>™</sup>
ActiveArray <sup>™</sup>	FACT Quiet series <sup>™</sup>	ISOPLANAR <sup>™</sup>	POP <sup>™</sup>	Stealth <sup>™</sup>
Bottomless <sup>™</sup>	FAST <sup>®</sup>	LittleFET <sup>™</sup>	Power247 <sup>™</sup>	SuperSOT <sup>™</sup> -3
CoolFET <sup>™</sup>	FAST <sup>r</sup> <sup>™</sup>	MicroFET <sup>™</sup>	PowerTrench <sup>®</sup>	SuperSOT <sup>™</sup> -6
CROSSVOLT <sup>™</sup>	FRFET <sup>™</sup>	MicroPak <sup>™</sup>	QFET <sup>™</sup>	SuperSOT <sup>™</sup> -8
DOME <sup>™</sup>	GlobalOptoisolator <sup>™</sup>	MICROWIRE <sup>™</sup>	QS <sup>™</sup>	SyncFET <sup>™</sup>
EcoSPARK <sup>™</sup>	GTO <sup>™</sup>	MSX <sup>™</sup>	QT Optoelectronics <sup>™</sup>	TinyLogic <sup>®</sup>
E <sup>2</sup> CMOS <sup>™</sup>	HiSeC <sup>™</sup>	MSXPro <sup>™</sup>	Quiet Series <sup>™</sup>	TruTranslation <sup>™</sup>
EnSigna <sup>™</sup>	I <sup>2</sup> C <sup>™</sup>	OCX <sup>™</sup>	RapidConfigure <sup>™</sup>	UHC <sup>™</sup>
Across the board. Around the world. <sup>™</sup>		OCXPro <sup>™</sup>	RapidConnect <sup>™</sup>	UltraFET <sup>®</sup>
The Power Franchise <sup>™</sup>		OPTOLOGIC <sup>®</sup>	SILENT SWITCHER <sup>®</sup>	VCX <sup>™</sup>
Programmable Active Droop <sup>™</sup>		OPTOPLANAR <sup>™</sup>	SMART START <sup>™</sup>	

## DISCLAIMER

FAIRCHILD SEMICONDUCTOR RESERVES THE RIGHT TO MAKE CHANGES WITHOUT FURTHER NOTICE TO ANY PRODUCTS HEREIN TO IMPROVE RELIABILITY, FUNCTION OR DESIGN. FAIRCHILD DOES NOT ASSUME ANY LIABILITY ARISING OUT OF THE APPLICATION OR USE OF ANY PRODUCT OR CIRCUIT DESCRIBED HEREIN; NEITHER DOES IT CONVEY ANY LICENSE UNDER ITS PATENT RIGHTS, NOR THE RIGHTS OF OTHERS.

## LIFE SUPPORT POLICY

FAIRCHILD'S PRODUCTS ARE NOT AUTHORIZED FOR USE AS CRITICAL COMPONENTS IN LIFE SUPPORT DEVICES OR SYSTEMS WITHOUT THE EXPRESS WRITTEN APPROVAL OF FAIRCHILD SEMICONDUCTOR INTERNATIONAL.

As used herein:

1. Life support devices or systems are devices or systems which, (a) are intended for surgical implant into the body, or (b) support or sustain life, or (c) whose failure to perform when properly used in accordance with instructions for use provided in the labeling, can be reasonably expected to result in significant injury to the user.
2. A critical component is any component of a life support device or system whose failure to perform can be reasonably expected to cause the failure of the life support device or system, or to affect its safety or effectiveness.

## PRODUCT STATUS DEFINITIONS

### Definition of Terms

Datasheet Identification	Product Status	Definition
Advance Information	Formative or In Design	This datasheet contains the design specifications for product development. Specifications may change in any manner without notice.
Preliminary	First Production	This datasheet contains preliminary data, and supplementary data will be published at a later date. Fairchild Semiconductor reserves the right to make changes at any time without notice in order to improve design.
No Identification Needed	Full Production	This datasheet contains final specifications. Fairchild Semiconductor reserves the right to make changes at any time without notice in order to improve design.
Obsolete	Not In Production	This datasheet contains specifications on a product that has been discontinued by Fairchild semiconductor. The datasheet is printed for reference information only.