

## Specification

- Part No. : **FMA103.A.AF.001**
- Product Name : Hercules Response 2 in 1 GPS/Galileo & First Net Permanent Mount Antenna
- Features : GPS/GALILEO – Two Stage 28dB+ LNA  
FirstNet Band 14 Coverage  
Low Profile, IP69K Rated Enclosure  
Heavy Duty, UV and Vandal Resistant PC Housing  
Permanent / Screw Mounting  
Cables: 3M RG174 / TGC200  
Connector: SMA(M)  
Dimensions: H: 29mm x Ø49mm  
**RoHS Compliant**



## 1. Introduction

The Hercules Response FMA103 GPS/GALILEO & FirstNet Combination Antenna is a combination high performance GPS/GALILEO and an LTE antenna that includes coverage on the FirstNet, Band 14 frequency.

FirstNet also known as Band 14 or PS-LTE (Public Service LTE) is a dedicated communications tool for First Responders in the US. It is an isolated network for providing faster critical information and data-sharing between blue light service providers and their agencies. New FirstNet devices are being deployed to allow for the multitude of services and applications which will be using the network for the following mission critical applications:

- Computer-aided dispatch (vehicle location)
- EMS Electronic Patient Care Reporting
- Vehicle Mounted RMS/ Citations/ Scanners
- Video Streaming

This antenna demonstrates extremely high efficiency also ensuring longer Battery life for high RF power handsets.

This antenna demonstrates extremely high efficiency which helps increase battery life for high RF power handsets. It is an ideal solution for reliable asset tracking, remote monitoring and public safety.

The durable, UV repellent PC housing helps resist vandalism and direct attacks. At just 29mm in height and a diameter of 49 mm, the Hercules can be mounted on metal or non-metal structures as it has a metal ground-plane base internally.

Cables and connectors are fully customizable, contact you regional Taoglas Sales Office for more information.

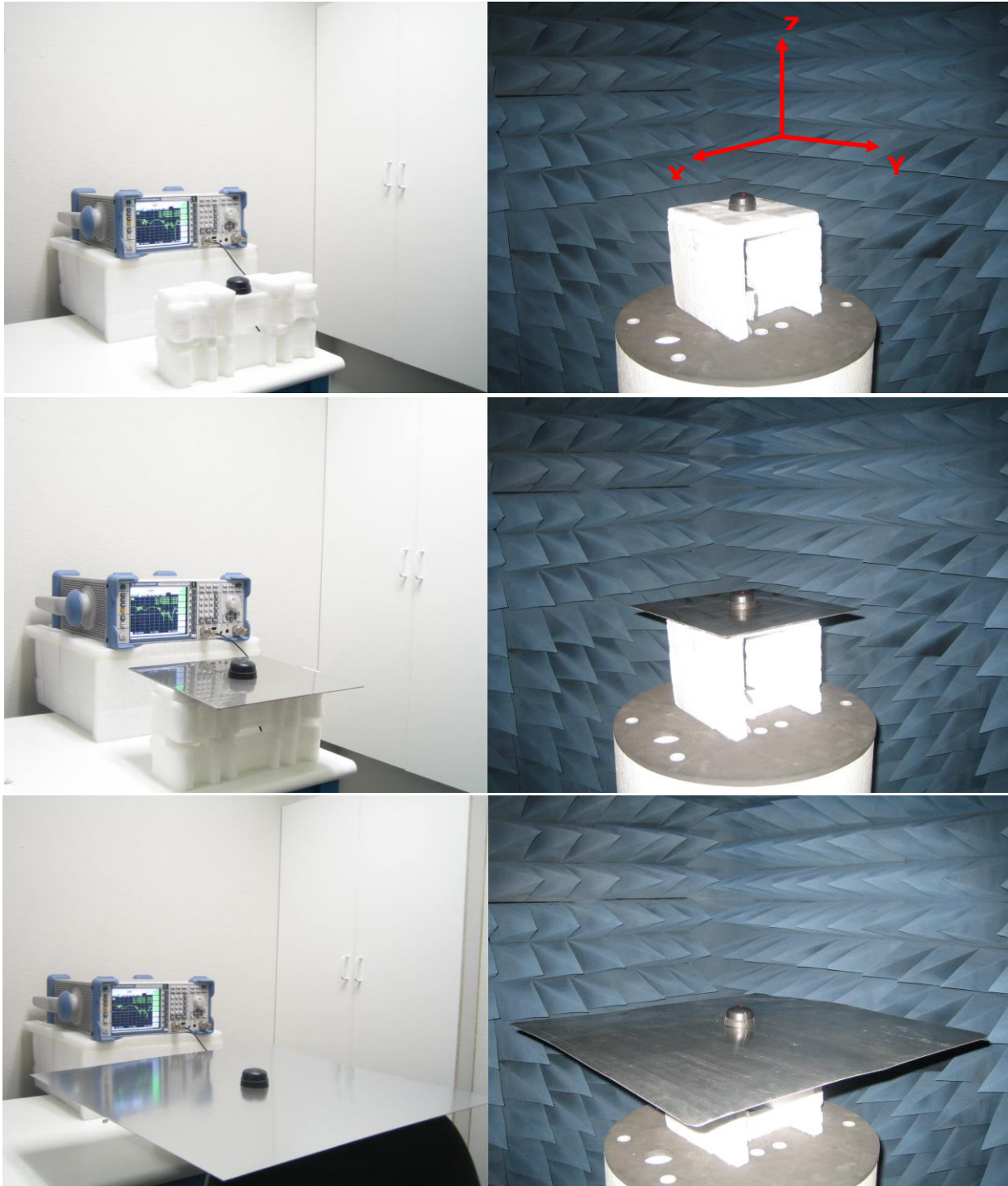
## 2. Specification

ELECTRICAL CELLULAR						
Standard		AMPS	GSM	PCS	DCS	3G
Band (MHz)		850	900	1900	1800	2100
Frequency (MHz)		824-896	880-960	1850-1990	1710-1880	1920-2170
Return Loss (dB)						
Cable length (meter)	0.3	-6.5	-6.0	-7	-8	-5
	1.0	-9.5	-8	-17	-16	-15
	2.0	-10	-9	-20	-21	-18
	3.0	-13	-11	-21	-21	-19
	5.0	-14	-14	-25	-25	-23
Efficiency (%)						
Cable length (meter)	0.3	38	54	58	54	50
	1.0	31	35	36	42	31
	2.0	23	20	23	32	21
	3.0	25	29	23	22	18
	5.0	11	11.5	12	11	11
Peak Gain (dBi)						
Cable length (meter)	0.3	2.0	3.3	4.0	3.6	3.0
	1.0	1.2	1.3	2	1.8	1.2
	2.0	0.5	-0.35	0	1.5	-0.1
	3.0	0.1	1.6	0.6	0.1	-0.9
	5.0	-2.5	-2.4	-2.3	-3.0	-2.0
Polarization		Linear				
Impedance		50 Ohms				
Input Power		10 Watts max.				
VSWR		<3.5.0:1				

<b>ELECTRICAL GPS/GALILEO</b>			
Frequency	1575.42MHz ± 1.023MHz		
Impedance	50 ohm		
VSWR	2.0 Max		
GPS/GALILEO Patch Gain	2.0dB Passive Gain @ Zenith -1.0dBi Gain @ 10 degrees elevation		
Axial ratio	3.0 dB max		
Polarization	RHCP		
Out Band Rejection	fo = 1575.42MHz fo ± 30 MHz 5dB Min. fo ± 50 MHz 20dB Min. fo ± 100 MHz 25dB Min.		
Input Voltage	Min: 1.8V	Typ. 3.0V	Max: 5.5V
Total Gain @ Zenith	25dBic	30dBic	32dBic
Current Consumption	6mA	12mA	30mA
Noise Figure	2.7dB	3.0dB	3.7dB
<b>MECHANICAL</b>			
Dimensions	Height 29mm x Diameter 49mm		
Casing	UV resistant PC		
Base and thread	Nickel plated steel		
Thread diameter	18mm		
Weather proof gasket	CR4305 foam with 3M9448B double-side adhesive		
Cable pull	8 Kgf		
Recommended Mounting Torque	24.5N·m		
Max Mounting Torque	29.4N·m		
Weight	200g		
<b>ENVIRONMENTAL</b>			
Waterproof	IP-67 & IP-69K		
Corrosion	5% NaCl for 48hrs - Nickel plated steel base and thread		
Temperature Range	-40°C to +85°C		
Thermal Shock	100 cycles -40°C to +80°C		
Humidity	Non-condensing 65°C 95% RH		
Shock (drop test)	1m drop on concrete 6 axes		

\*Note: The return loss, efficiency and gain measurements in the above table, were taken for the antenna mounted on a 30x30 cm metal plate. For a specific case performance refers to the below plots.

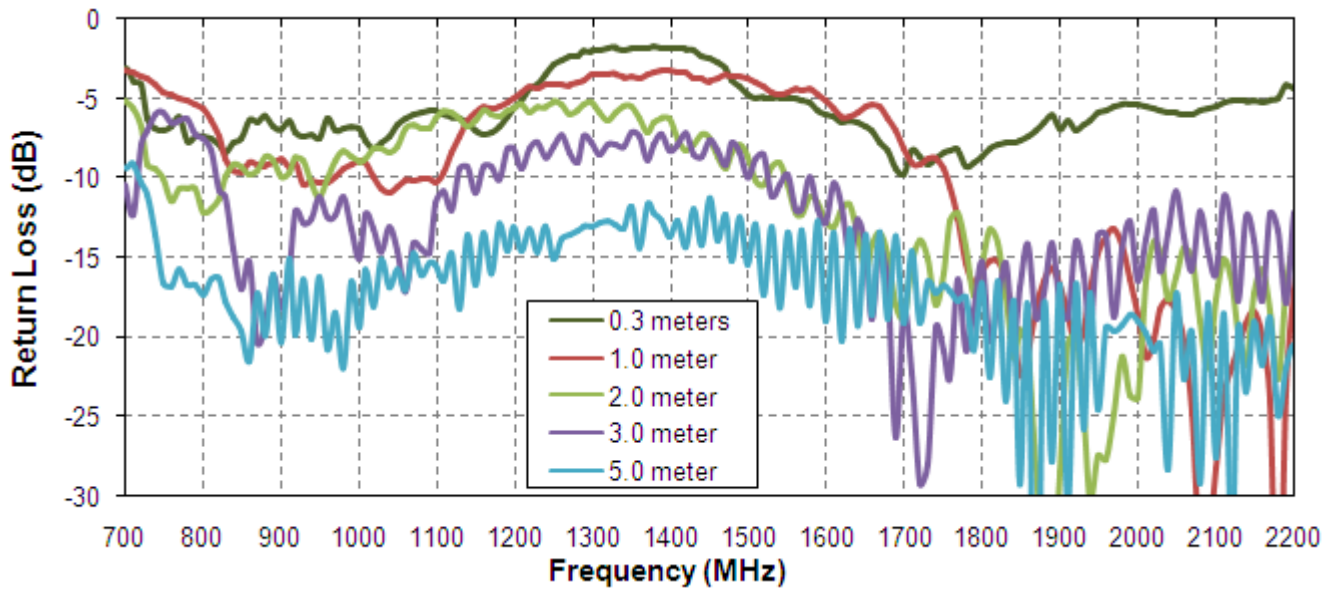
### 3. Test Setup



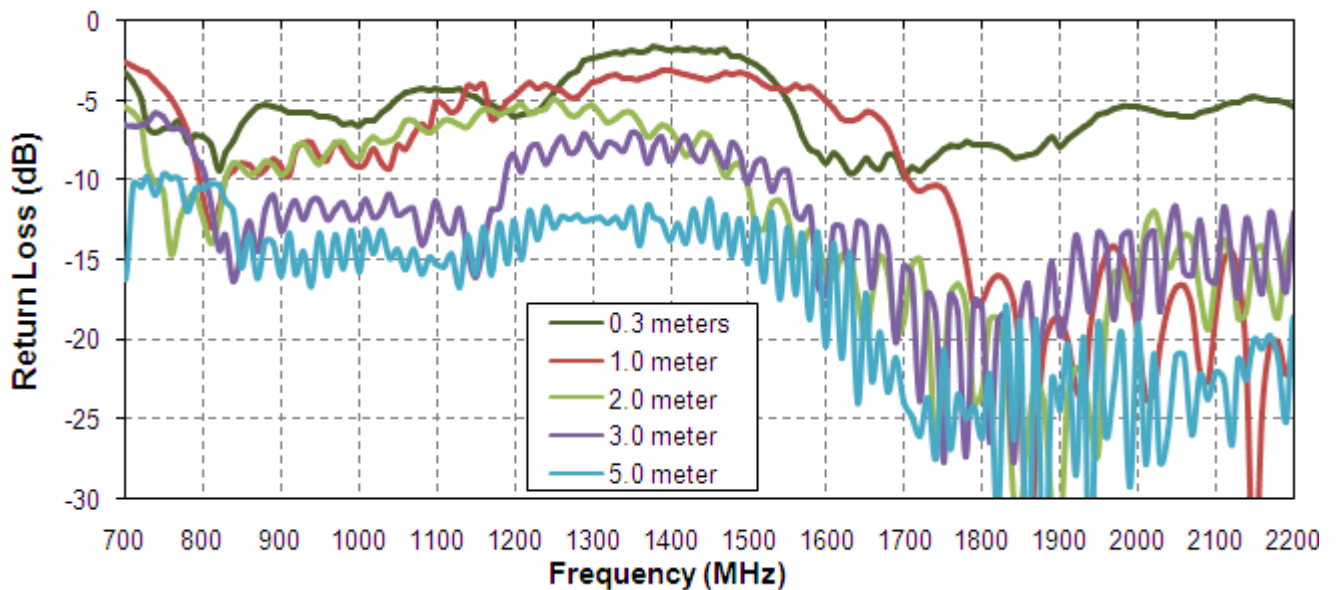
**Figure 1.** FMA103 Antenna test set up in free space, 30x30 cm metal plate and 60x60 cm

## 4. Antenna Parameters

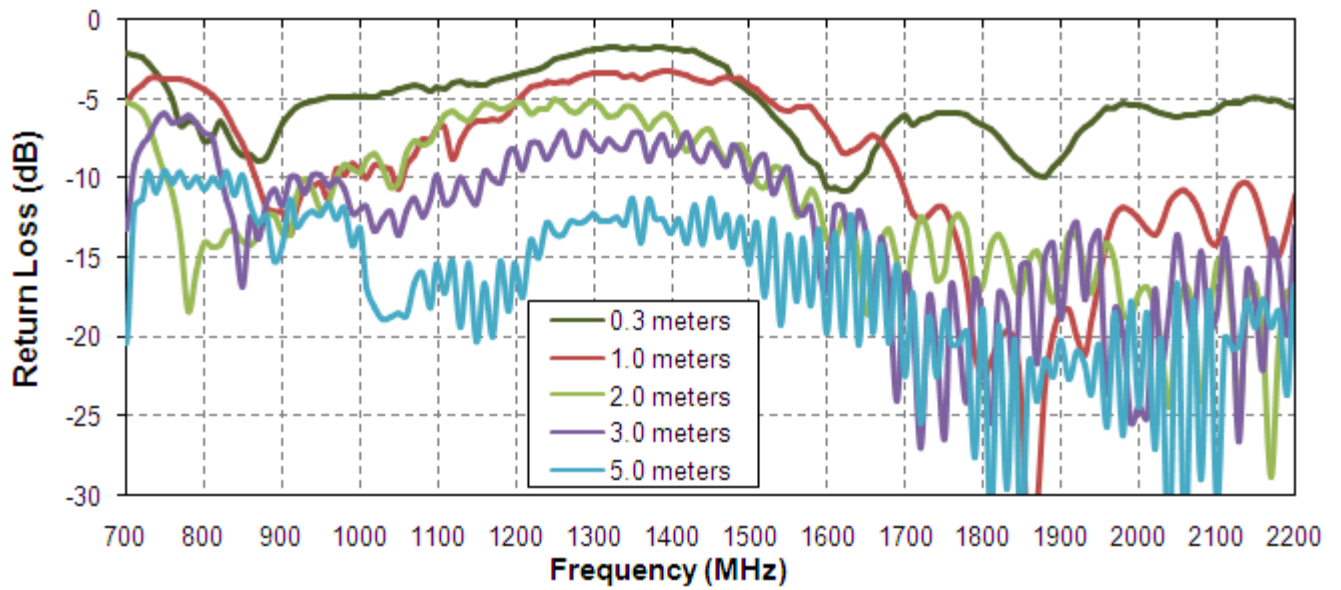
### 4.1 Return Loss



**Figure 2.** Return Loss of the FMA103 antenna in free space



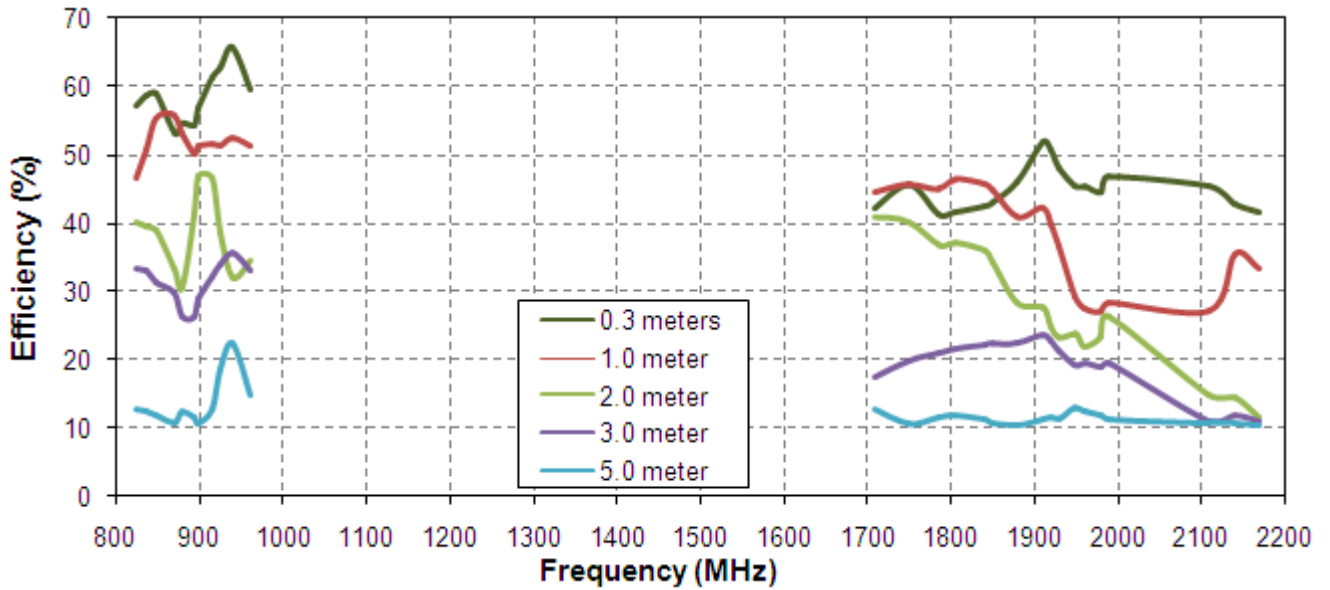
**Figure 3.** Return Loss of the FMA103 antenna on 30\*30cm metal plate



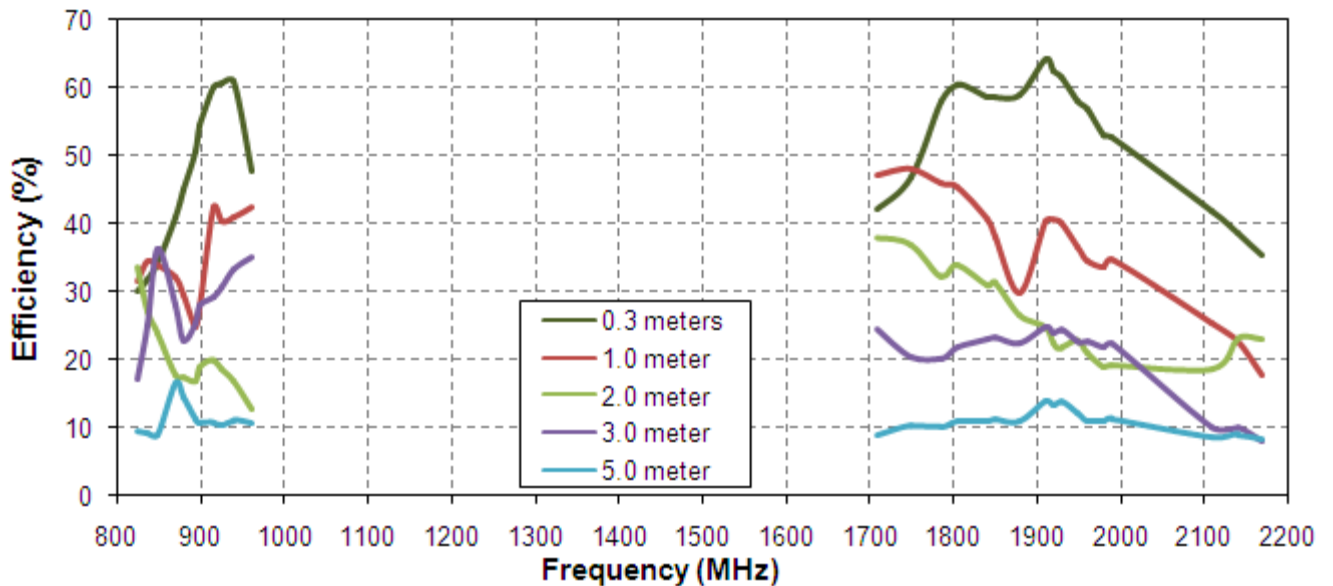
**Figure 4.** Return Loss of the FMA103 antenna on 60\*60cm metal plate



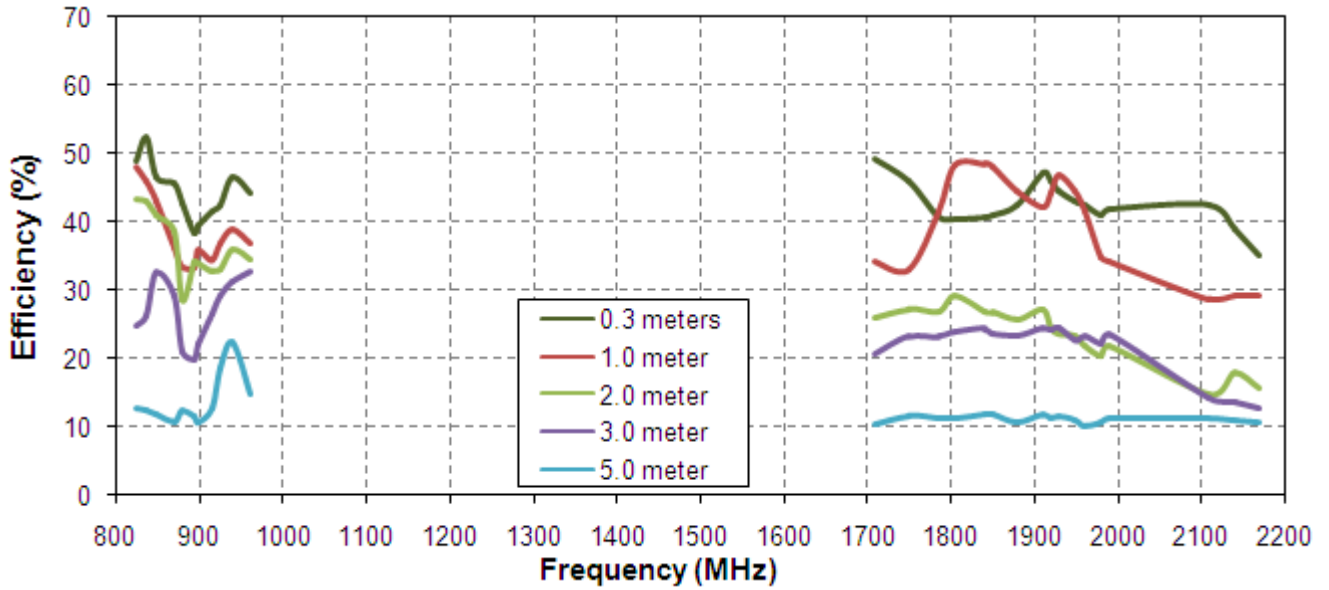
## 4.2 Efficiency



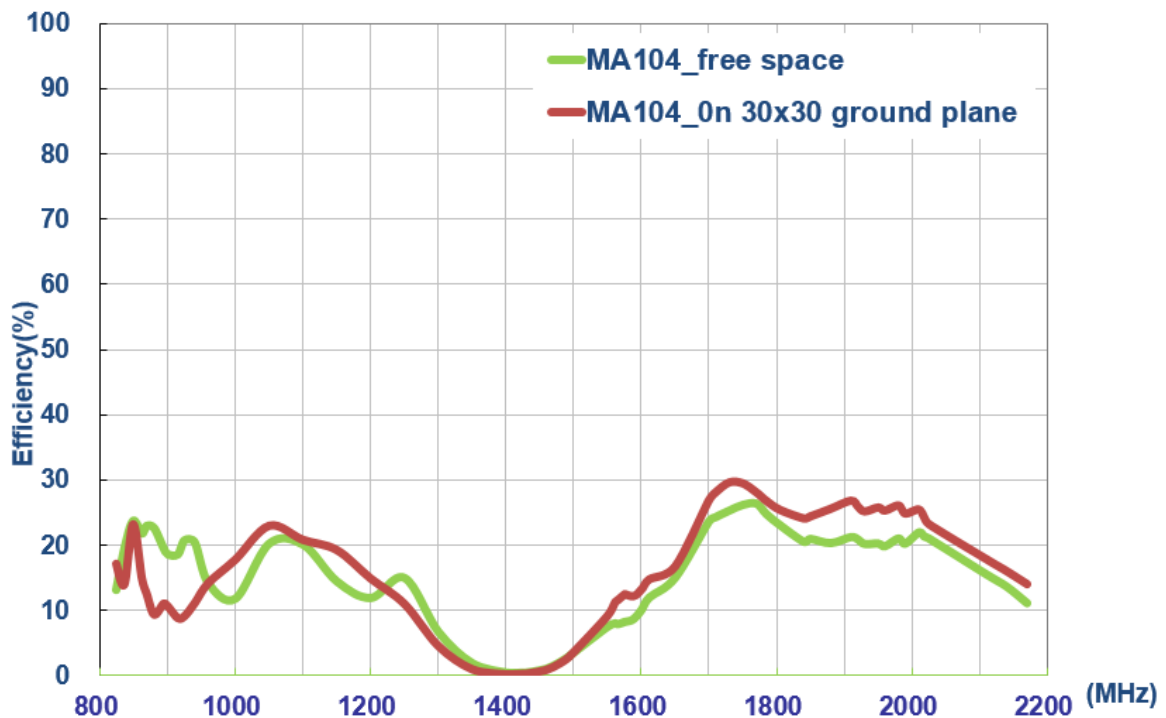
**Figure 5.** Efficiency of the FMA103 antenna in free space



**Figure 6.** Efficiency of the FMA103 antenna on 30\*30cm metal plate

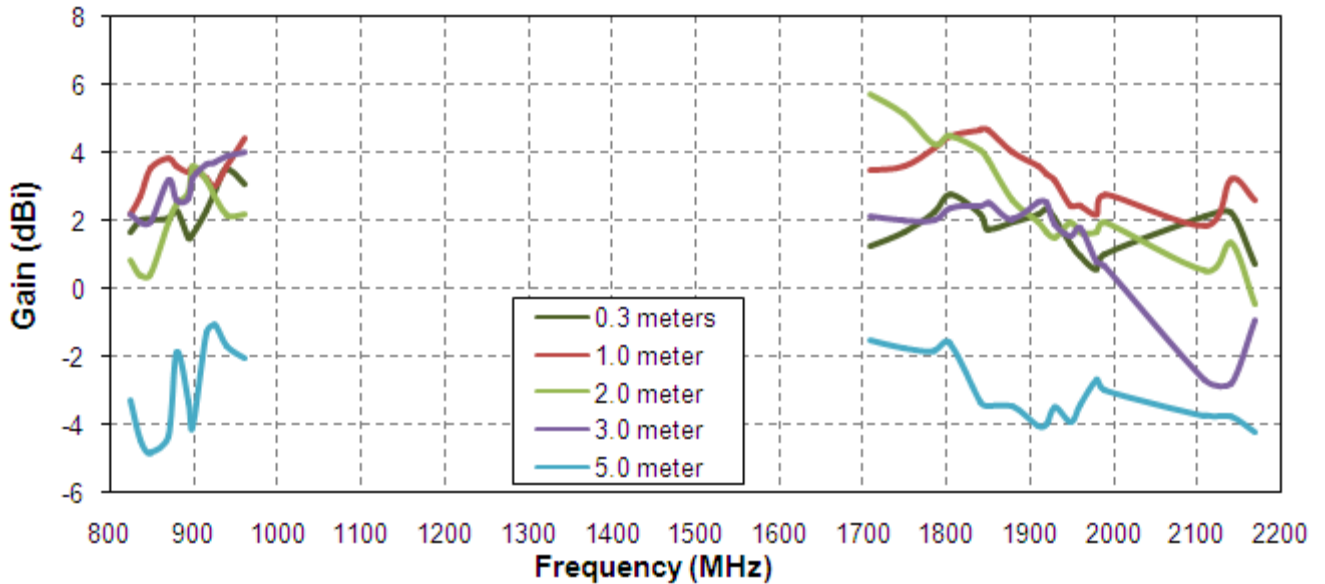


**Figure 7.** Efficiency of the FMA103 antenna on 60\*60cm metal plate.

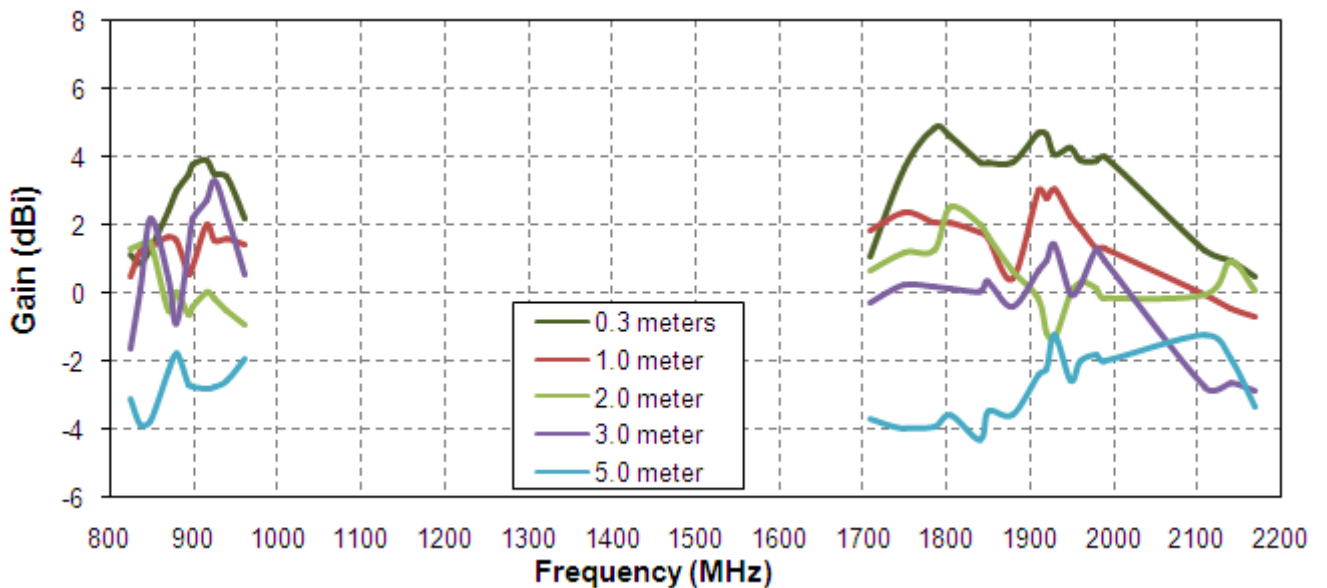


**Figure 8.** Efficiency of the FMA103 antenna with 960~1700MHz

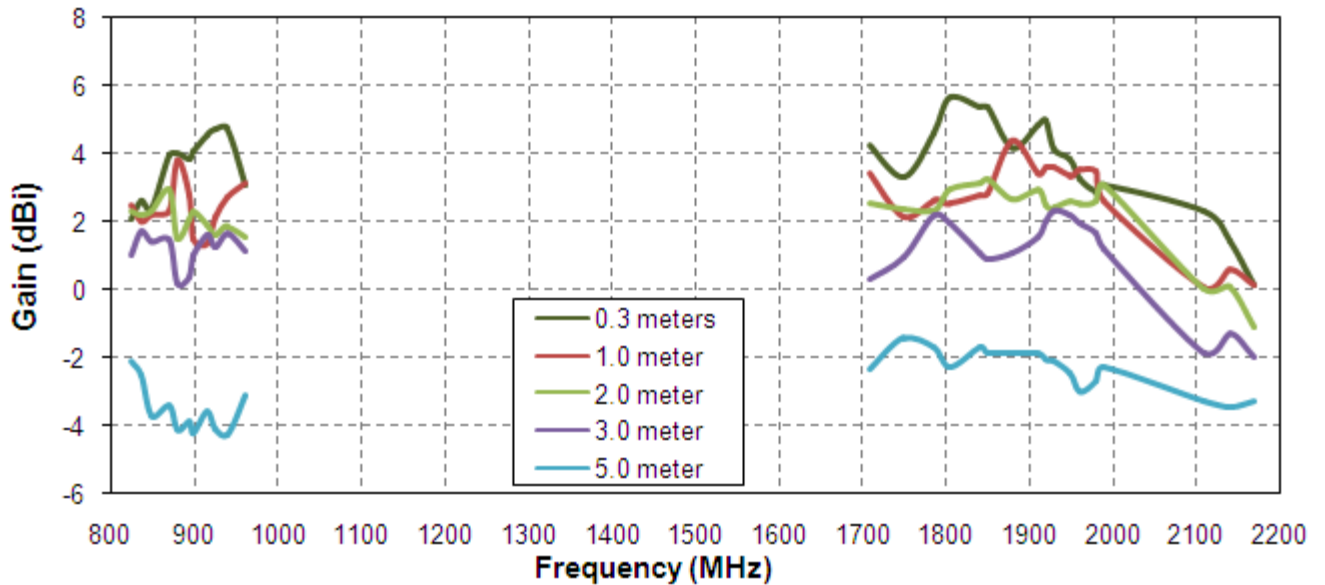
### 4.3 Peak Gain



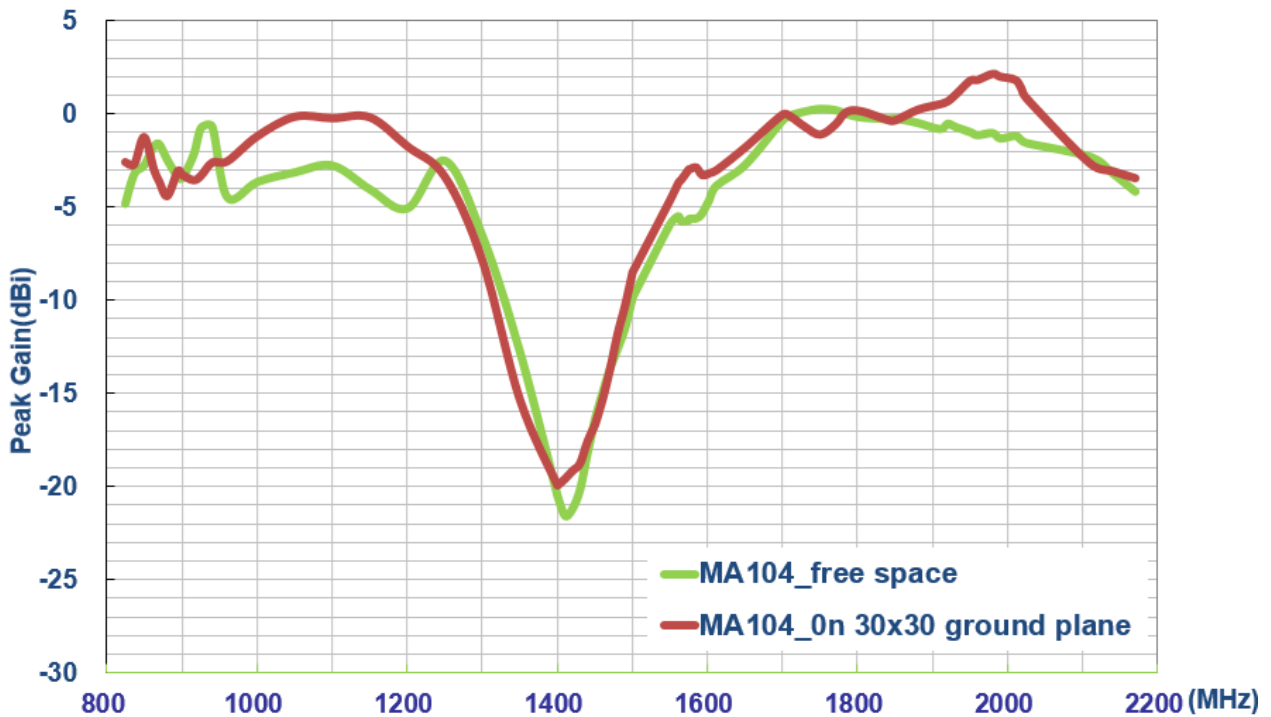
**Figure 9.** Gain of the FMA103 antenna in free space



**Figure 10.** Gain of the FMA103 antenna on 30\*30cm metal plate

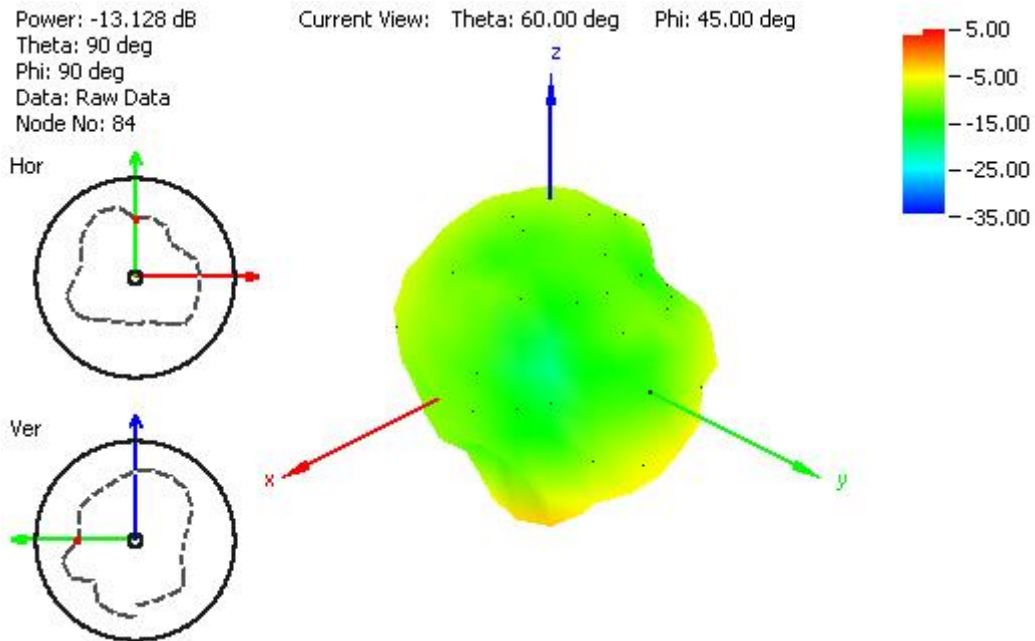


**Figure 11.** Gain of the FMA103 antenna on 60\*60cm metal plate

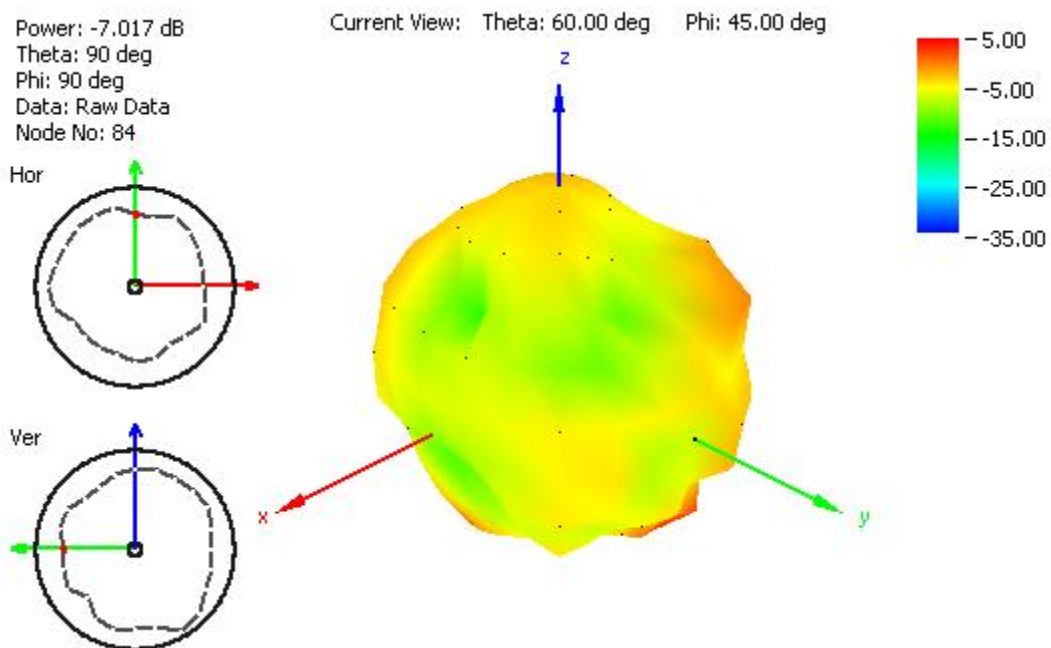


**Figure 12.** Gain of the FMA103 antenna from 960~1700MHz

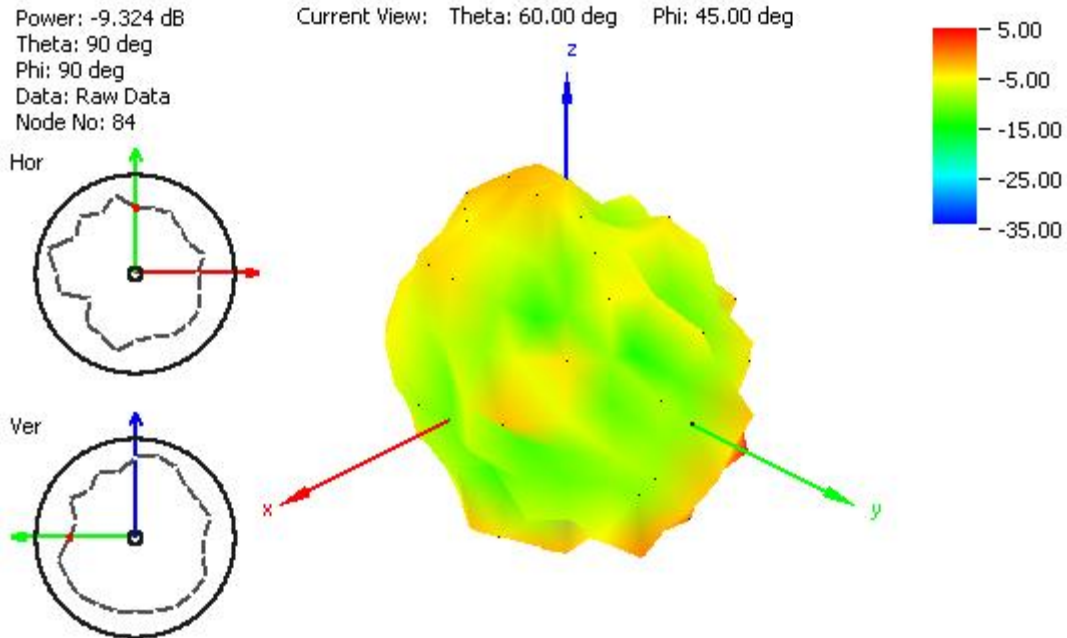
## 4.4 Radiation pattern



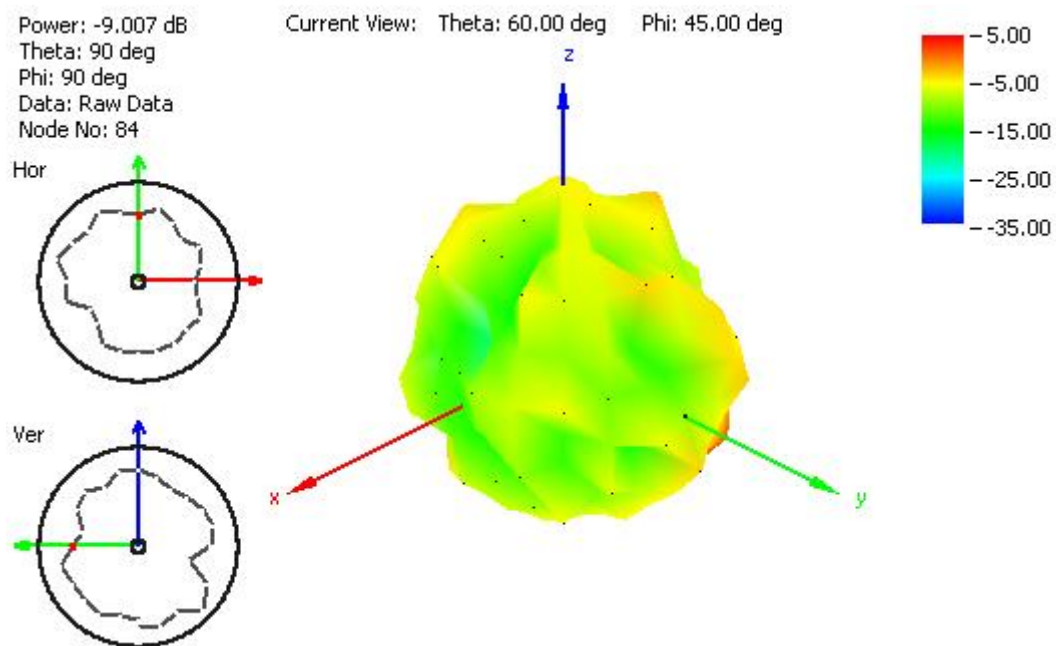
**Figure 13.** Radiation pattern at 849 MHz, Figure 1 as reference (dB), with 2 m RG174 cable and free space



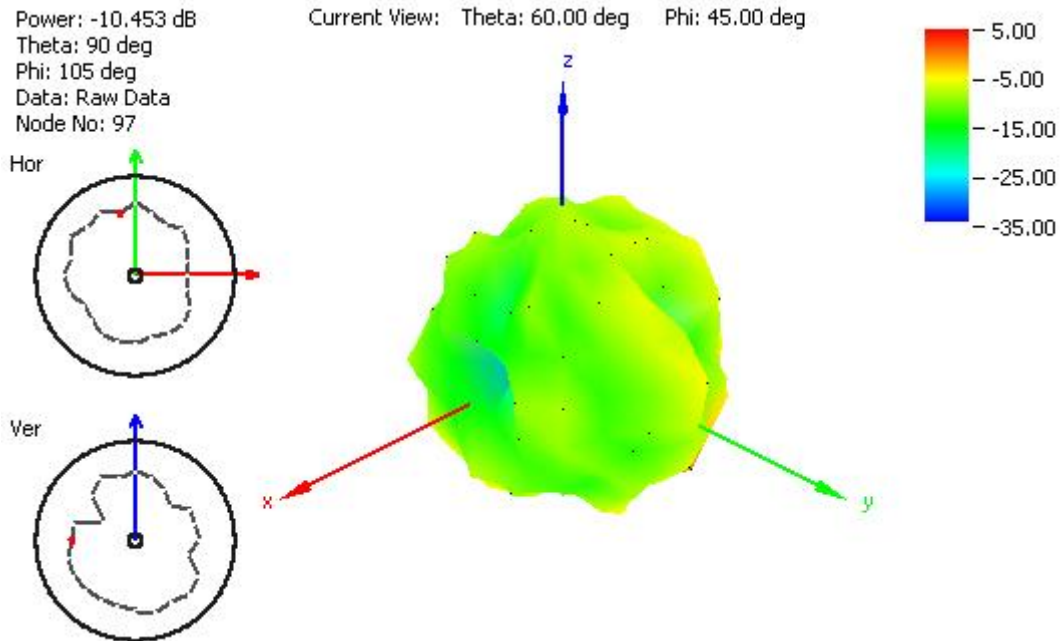
**Figure 14.** Radiation pattern at 915 MHz, Figure 1 as reference (dB), with 2 m RG174 cable and free space



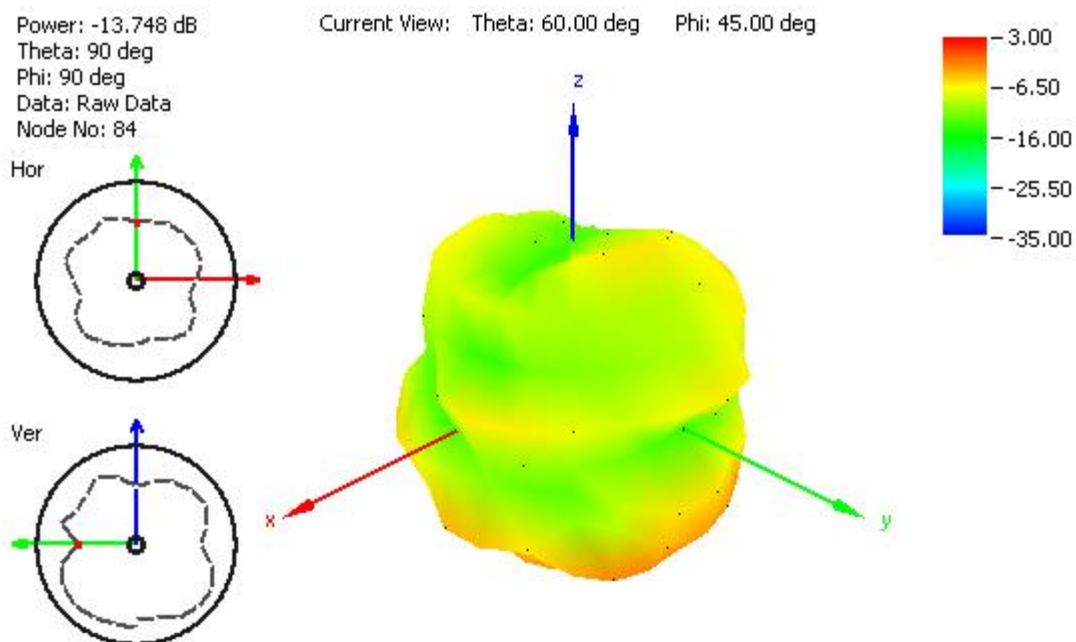
**Figure 15.** Radiation pattern at 1805 MHz, Figure 1 as reference (dB), with 2 m RG174 cable and free space



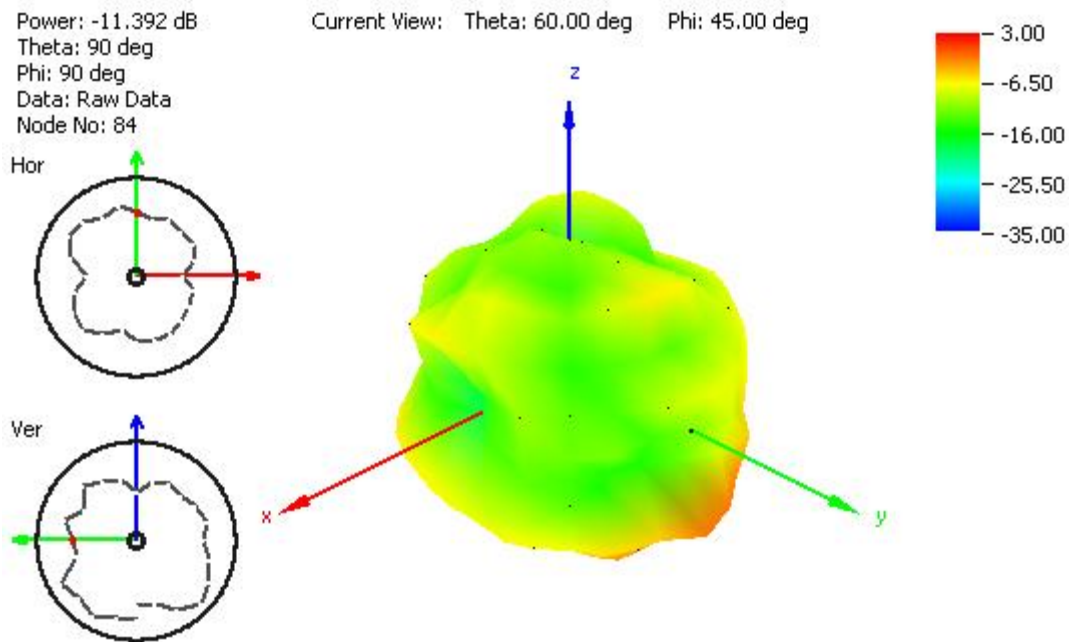
**Figure 16.** Radiation pattern at 1910 MHz, Figure 1 as reference (dB), with 2 m RG174 cable and free space



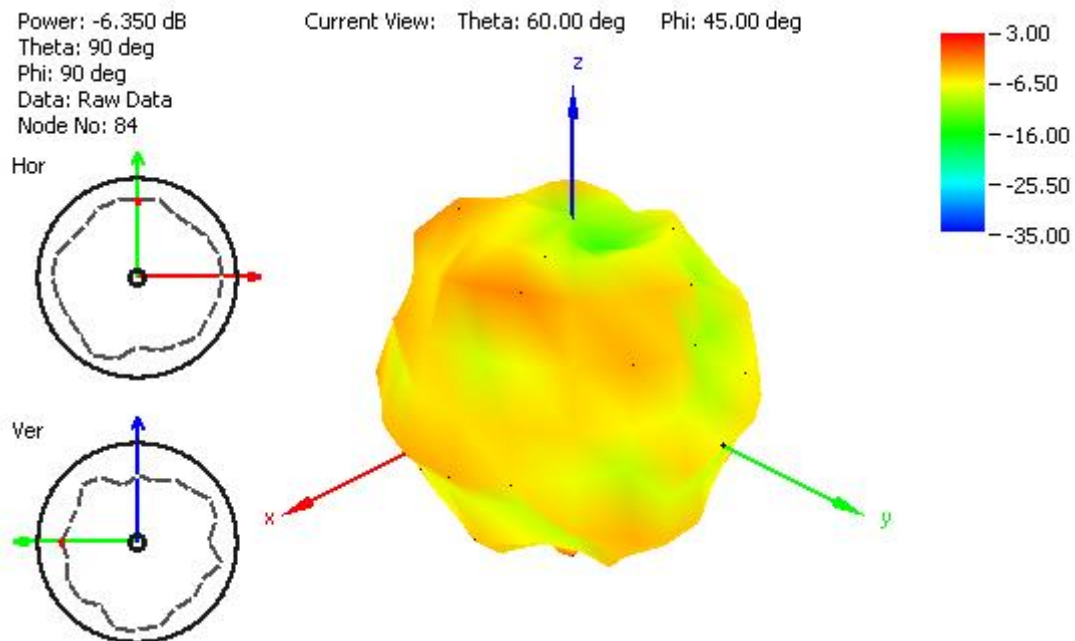
**Figure 17.** Radiation pattern at 2110 MHz, Figure 1 as reference (dB), with 2 m RG174 cable and free space.



**Figure 18.** Radiation pattern at 849 MHz, Figure 1 as reference (dB), with 2 m RG174 cable and 30x30 cm metal plate

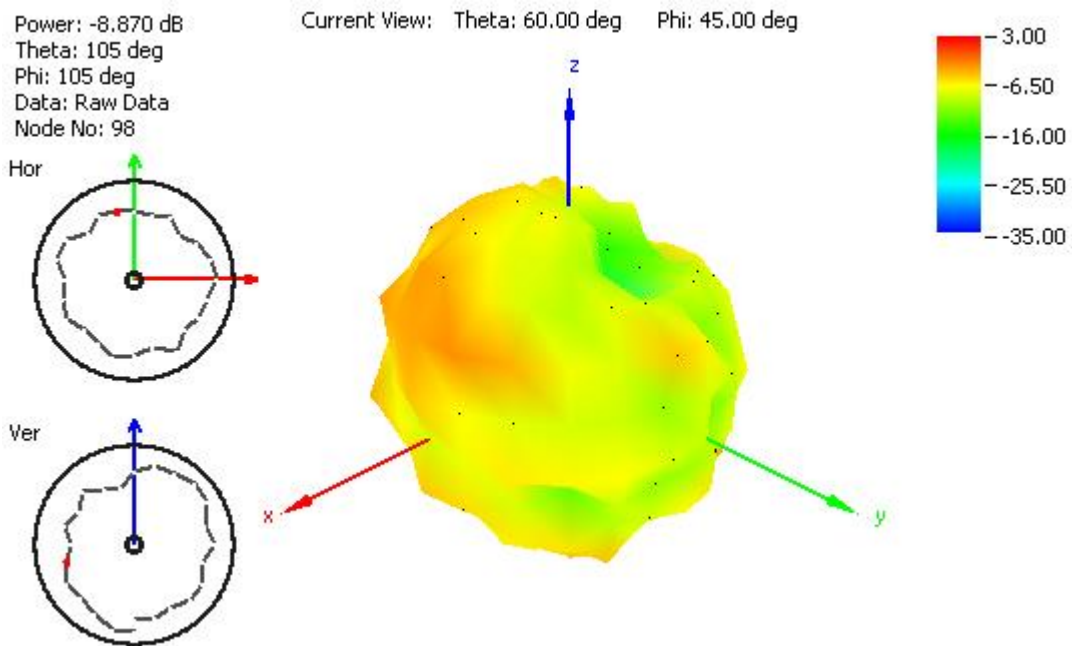


**Figure 19.** Radiation pattern at 915 MHz, Figure 1 as reference (dB), with 2 m RG174 cable and 30x30 cm metal plate

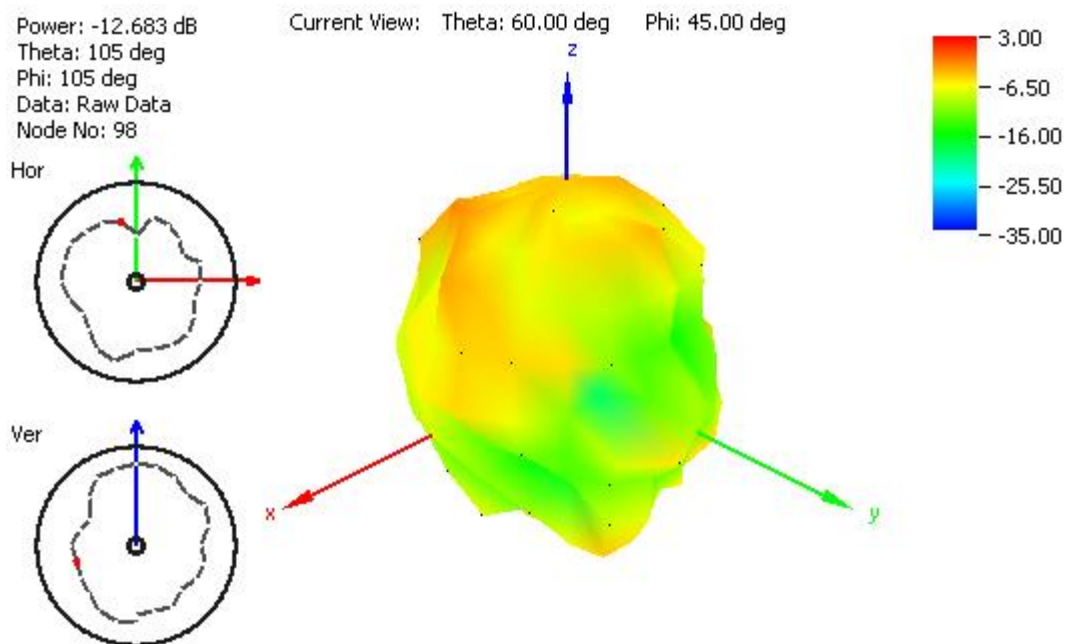


**Figure 20.** Radiation pattern at 1805 MHz, Figure 1 as reference (dB), with 2 m RG174 cable and 30x30 cm metal plate

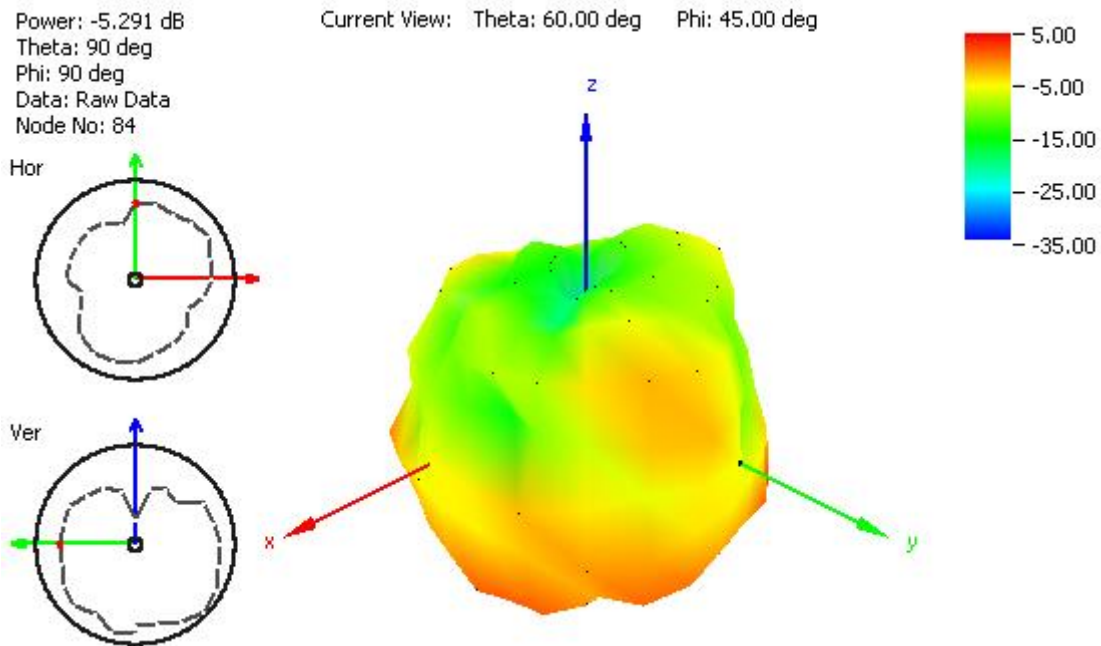




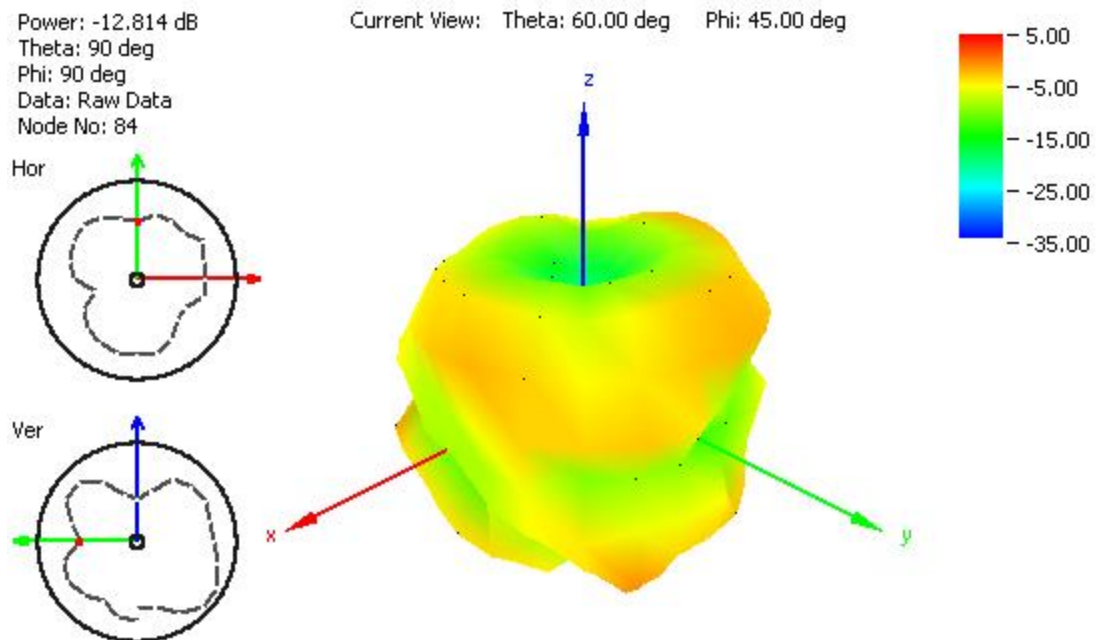
**Figure 21.** Radiation pattern at 1910 MHz, Figure 1 as reference (dB), with 2 m RG174 cable and 30x30 cm metal plate



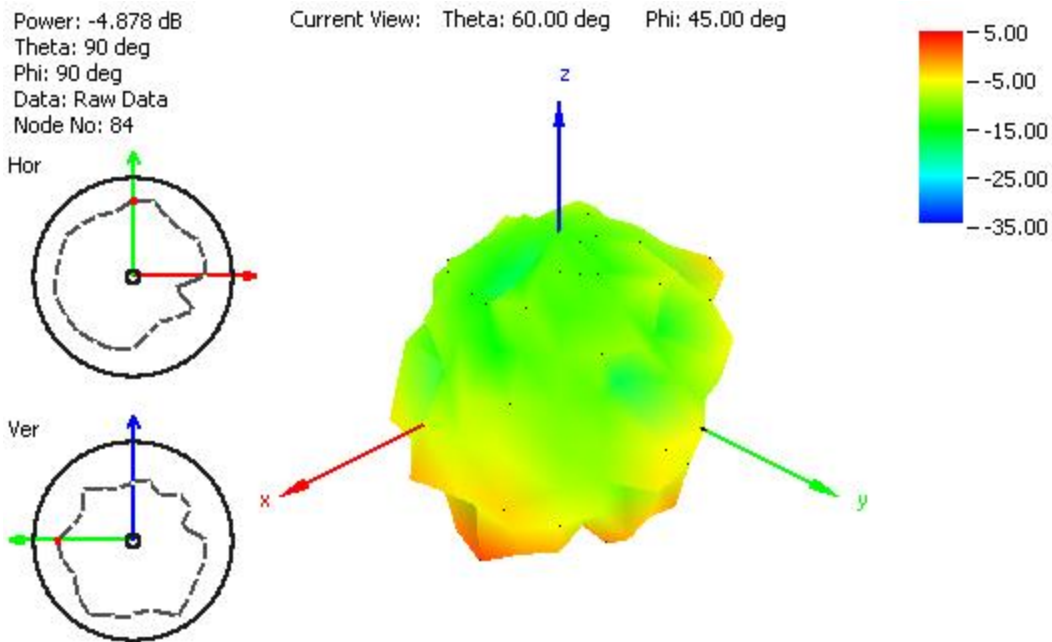
**Figure 22.** Radiation pattern at 2110 MHz, Figure 1 as reference (dB), with 2 m RG174 cable and 30x30 cm metal plate



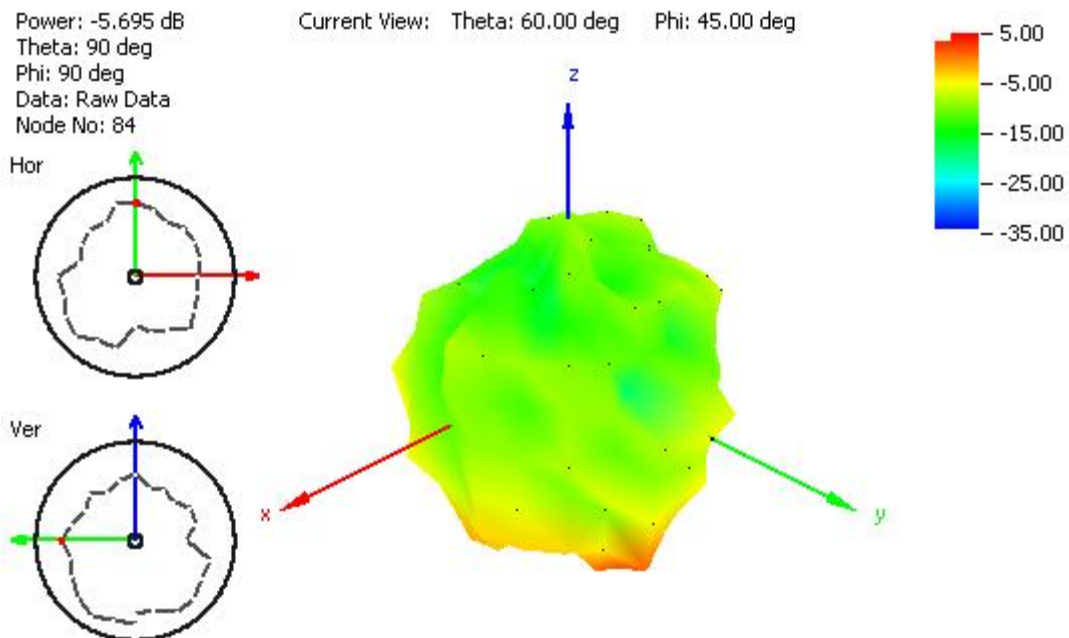
**Figure 23.** Radiation pattern at 849 MHz, Figure 1 as reference (dB), with 2 m RG174 cable and 60x60 cm metal plate



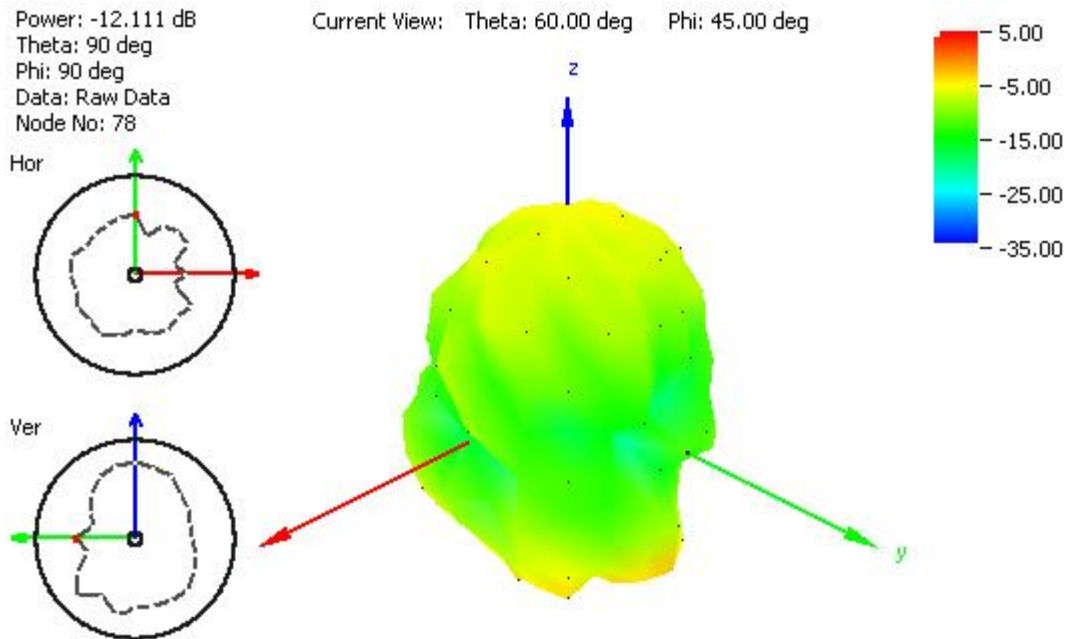
**Figure 24.** Radiation pattern at 915 MHz, Figure 1 as reference (dB), with 2 m RG174 cable and 60x60 cm metal plate



**Figure 25.** Radiation pattern at 1805 MHz, Figure 1 as reference (dB), with 2 m RG174 cable and 60x60 cm metal plate

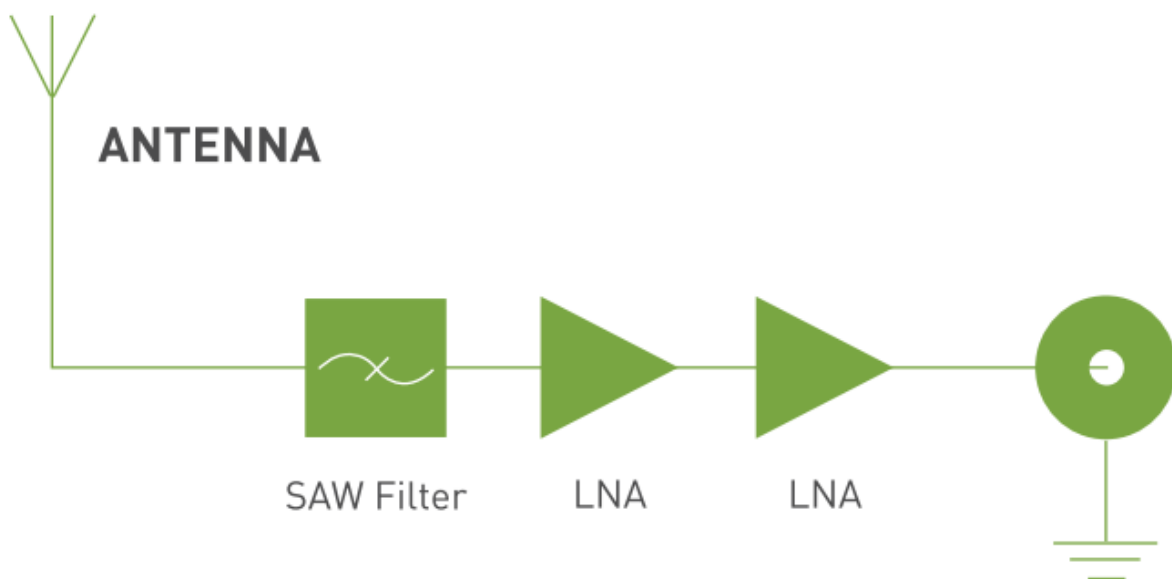


**Figure 26.** Radiation pattern at 1910 MHz, Figure 1 as reference (dB), with 2 m RG174 cable and 60x60 cm metal plate

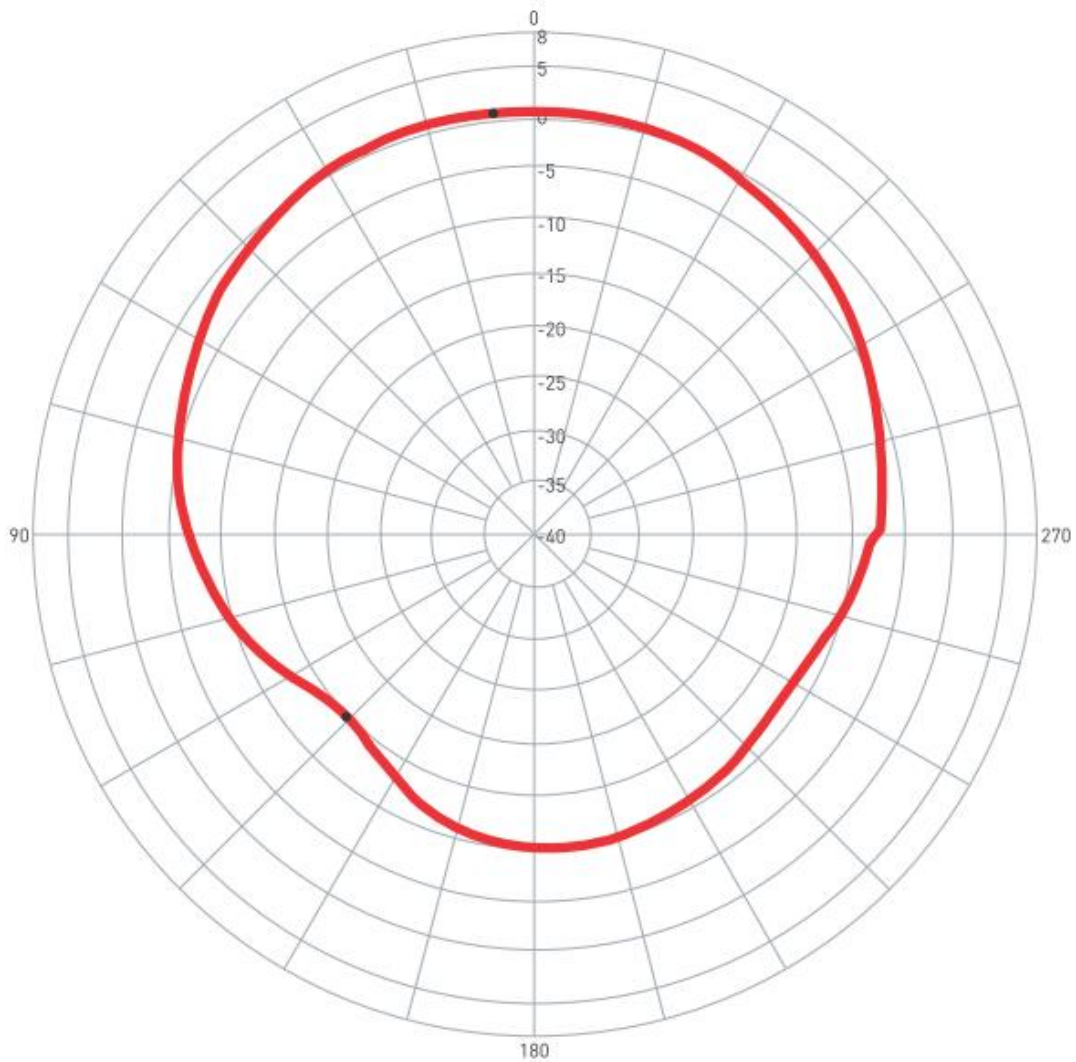


**Figure 27.** Radiation pattern at 2110 MHz, Figure 1 as reference (dB), with 2 m RG174 cable and 60x60 cm metal plate

## 5. System Block Diagram



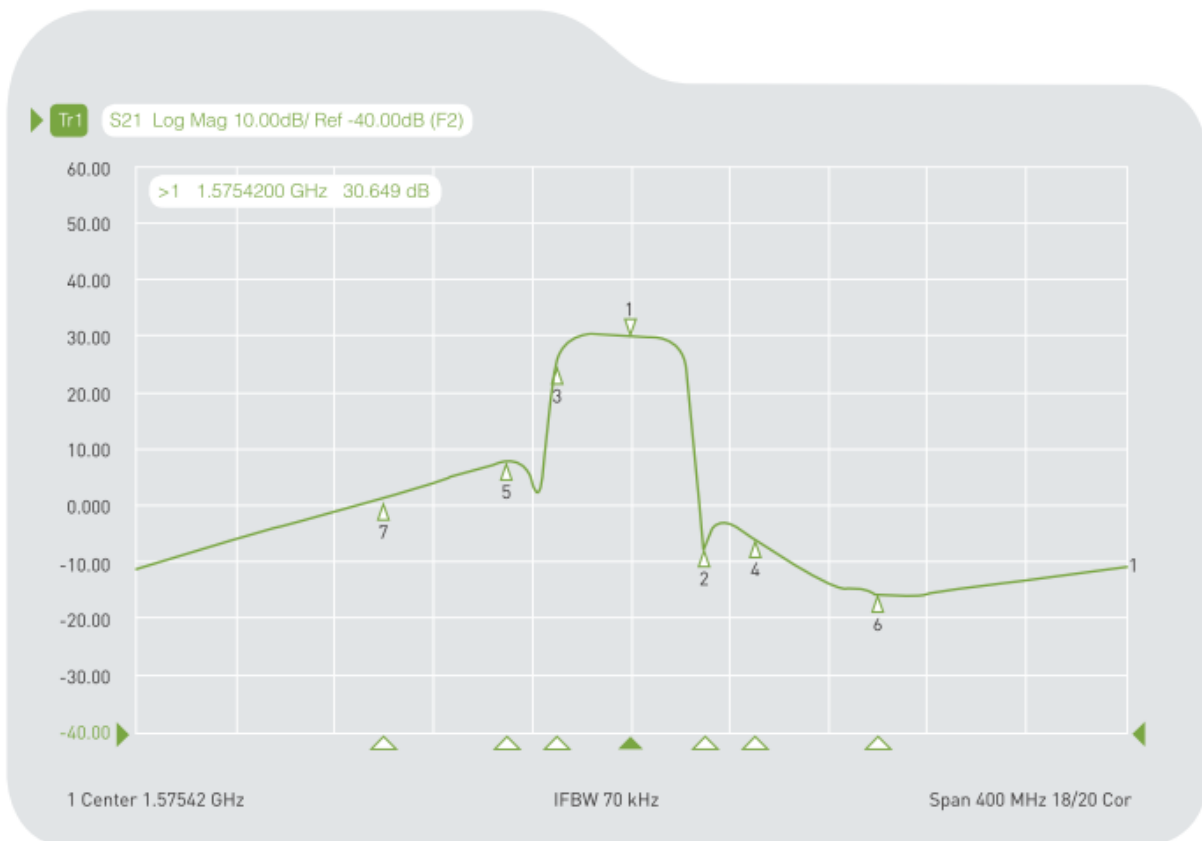
## 6. GPS/GALILEO Patch Radiation Pattern



0 degree is the top of Hercules.

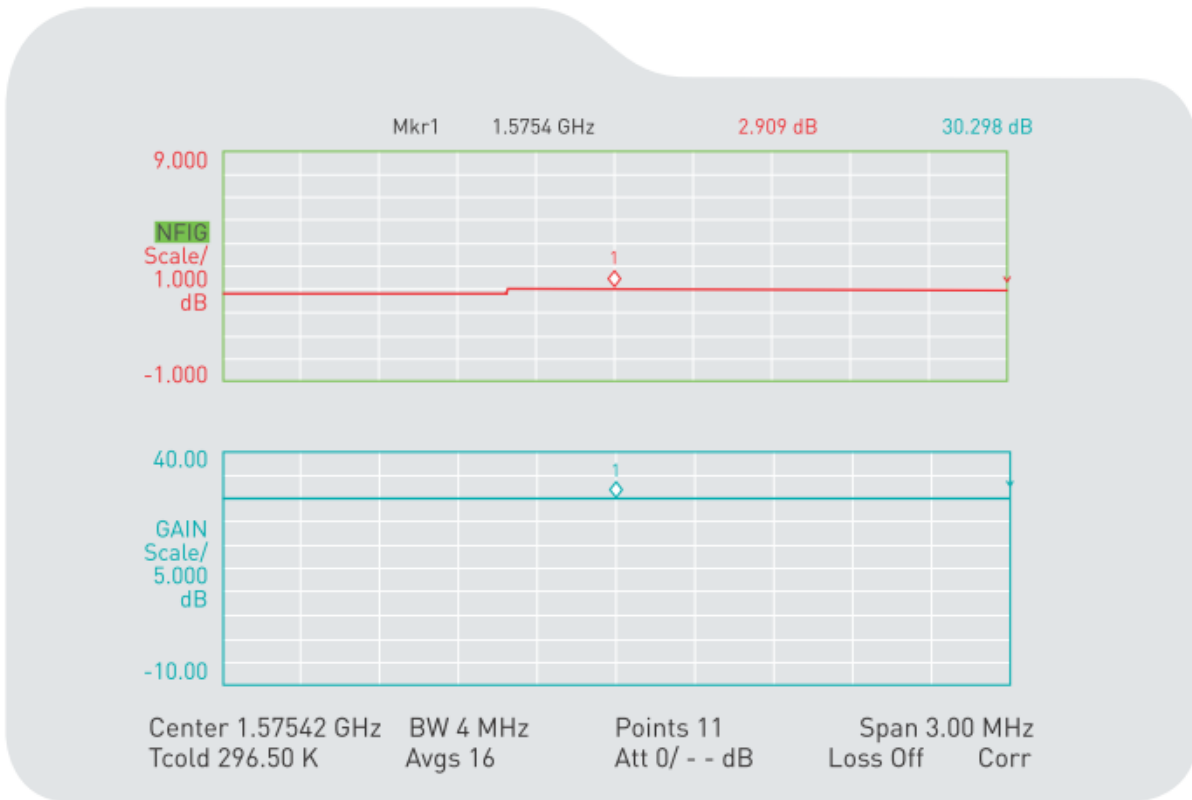
## 7. LNA Properties

### 7.1 LNA Gain and Out-band Rejection @ 3.0V



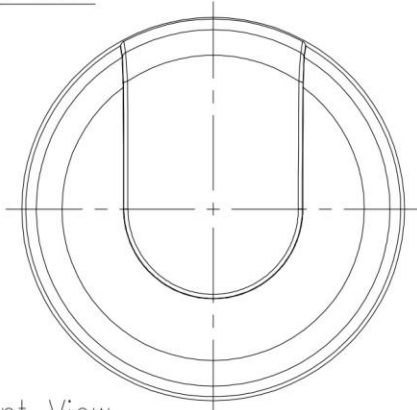
Cg1	Tr1	S21	>1	1.5754200 GHz	30.649 dB
Cg1	Tr1	S21	2	1.6054200 GHz	-6.7098 dB
Cg1	Tr1	S21	3	1.5454200 GHz	24.584 dB
Cg1	Tr1	S21	4	1.6254200 GHz	-5.6354 dB
Cg1	Tr1	S21	5	1.5254200 GHz	8.0734 dB
Cg1	Tr1	S21	6	1.6754200 GHz	-15.436 dB
Cg1	Tr1	S21	7	1.4754200 GHz	-1.5714 dB

## 7.2 Noise Figure

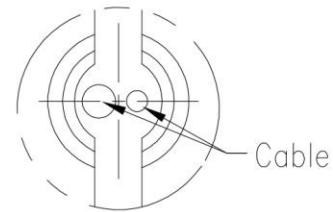


## 8. Drawing (Unit: mm)

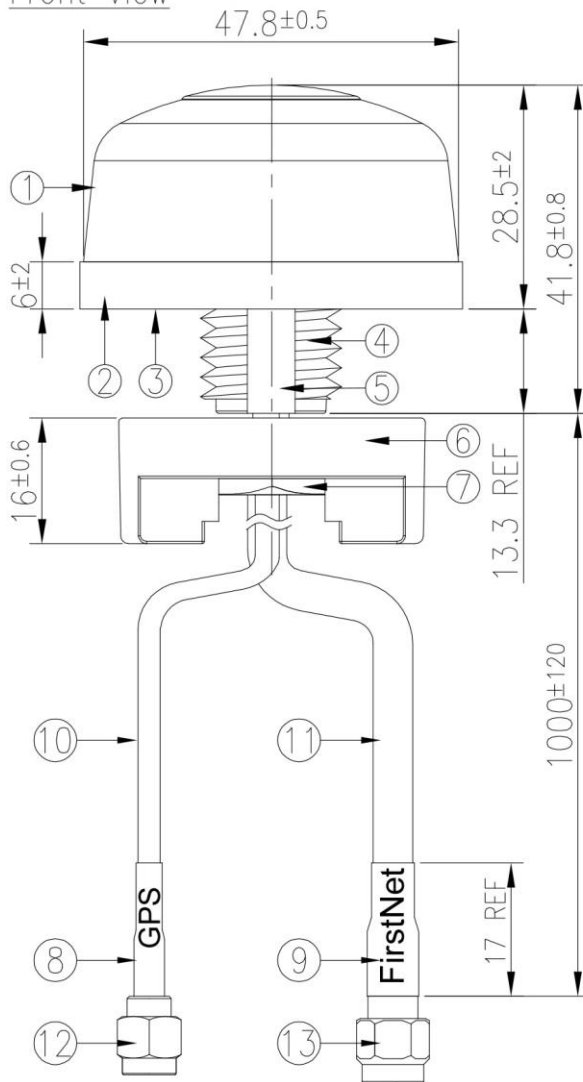
Top View



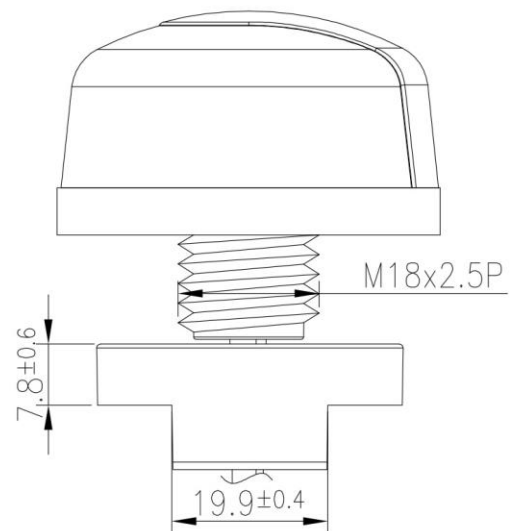
Bottom Thread View



Front View



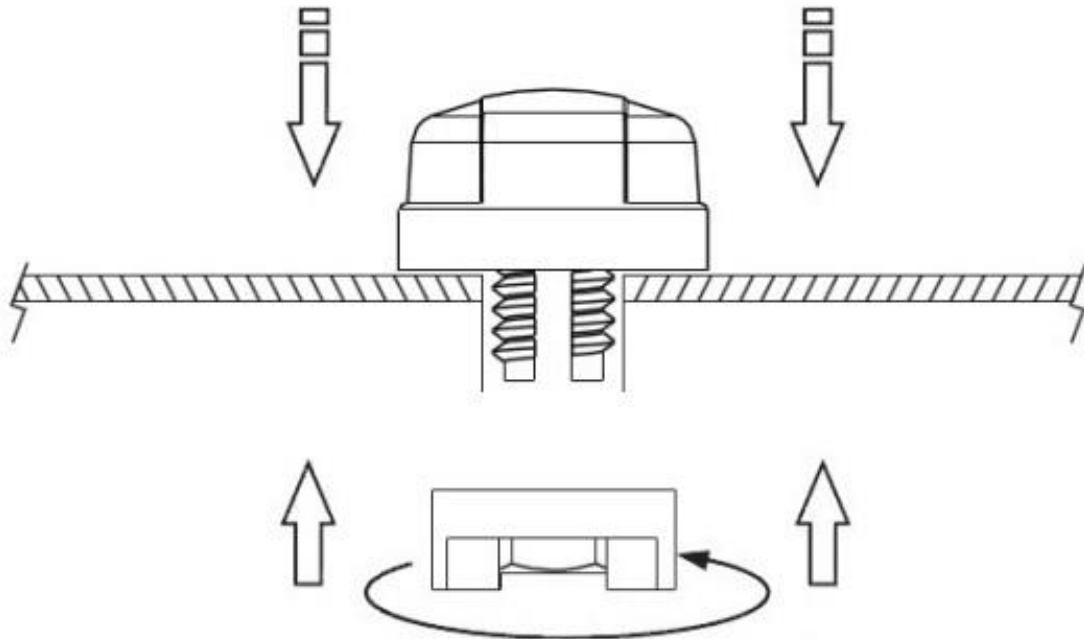
Side View



	Name	Material	Finish	QTY
1	Housing	PC	Black	1
2	Closed Cell Foam	CR 4305	Black	1
3	3M Double Adhesive	3M 9448 HK	White Liner	1
4	Metal Base	Zinc Alloy	Ni Plated	1
5	Rubber Stopper	Silicone Rubber	Black	1
6	Outer Nut Cover	ASA	Black	1
7	M18 Inner Nut	Steel Carbon	Zn Plated	1
8	Heat Shrink Tube (GPS)	PE	Blue Tube/White Text	1
9	Heat Shrink Tube (FirstNet)	PE	Red Tube/White Text	1
10	RG174 Coaxial Cable	PVC	Black	1
11	TGC200 Coaxial Cable	PE	Black	1
12	SMA(M)ST for RG174	Brass	Au Plated	1
13	SMA(M)ST for TGC200	Brass	Au Plated	1



## 9. Installation

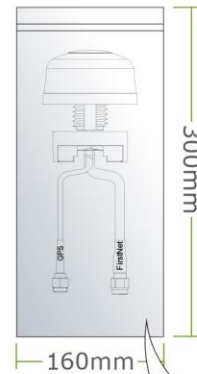


Recommended torque for Mounting is 24.5N·m  
Maximum torque for mounting is 29.4N·m



## 10. Packaging

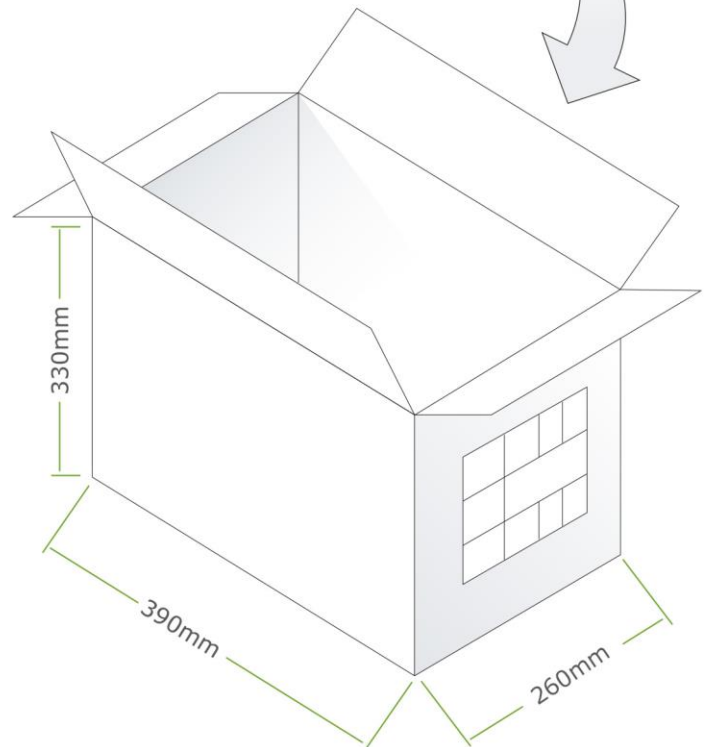
1pcs FMA103.A.AF.001 per Small PE Bag  
Bag Dimensions - 160\*300mm  
Weight - 193g



10pcs FMA103.A.AF.001 per Large PE Bag  
Bag Dimensions - 280\*450mm  
Weight - 1.93Kg



60pcs FMA103.A.AF.001 per carton  
Carton - 390\*260\*330mm  
Weight - 12Kg



Taoglas makes no warranties based on the accuracy or completeness of the contents of this document and reserves the right to make changes to specifications and product descriptions at any time without notice. Taoglas reserves all rights to this document and the information contained herein.

Reproduction, use or disclosure to third parties without express permission is strictly prohibited.

Copyright © Taoglas Ltd.