



101 Segment, 4 Digit 0.32" LEDs
in a 9/64 DIN CASE

General Features

- Standard Input Range
 - 4-20mA
 - IP01 : 4-20mA Process Loop
 - IP02 : 4-20mA Process Loop with Excitation 24VDC@100mA
 - 0-10V
 - ID01 : DC-Volts 2/20/200V with 24V DC Exc
 - ID05 : DC-Volts 2/20/200V with offset and 24V DC Exc
- Optional isolated 16 bit analog output. User or factory scalable to 4 to 20 mA, 0 to 20 mA or 0 to 10 V across any desired digital span from \pm one count to the full scale range of -1999 to 9999.
- A Programmable Tricolor (Red-Green-Orange) or mono color (red or green), 101 segment high brightness bargraph. Vertical or optional horizontal format.
- Red 4-digit LED display with a range of -1999 to 9999. Optional green digital display.
- Front panel LED annunciators provide indication of setpoint status.
- Two 9 Amp Form C, and two 4 Amp Form A relays available
- Provision to connect an external programming lockout switch.
- Provision for external DIM switch to reduce the brightest display setting by 50%.
- Optional NEMA-4 front cover.
- Automatic intelligent averaging, smooths noisy signals while providing a fast display response to real level changes.
- UL Listed

Software Features

- The bargraph can display, full scale, any desired portion of the digital reading.
- Bargraph center zero function.
- Four programmable setpoints with adjustable Hysteresis.
- Setpoint 1 has delay-on-make and delay-on-break plus a special "pump on pump off" mode that creates a Hysteresis Band between SP1 and SP2.
- Relay activation can be selected to occur above (hi) or below (Lo) each setpoint.
- Digital display blanking.
- Decimal point setting.
- Four-level brightness control accessed by the button and adjusted by the button.

FL-BDPSF-PROCESS

Smart 4-20mA/0-10V process Tri or Mono-color digital bargraph with four fully programmable set points and Isolated 4-20 mA analog output capability

Built-in Programmable Scale Factor
No Input required to calibrate

Specifications

- Input Specs:** Series connection to 4-20mA process loop or Single ended 0-10V DC
- A/D Converter:** 14 bit single slope
- Accuracy:** \pm (0.05% of reading + 2 counts)
- Temp. Coeff.:** 100 ppm/ $^{\circ}$ C (Typical)
- Warm up time:** 2 minutes
- Conversion Rate:** 10 conversions per second (Typical)
- Digital Display:** **4 digit 0.31" LED red (std), green (optn)**
Range -1999 to 9999 counts.
- Bargraph Display:** **101 segment 4" red vertical (std), green or tricolor (optn), horizontal (optn)**
- Polarity:** Assumed positive. Displays - negative
- Decimal Selection:** Front panel button selectable, X•X•X•X•
- Positive Overrange:** Bargraph and top segments of digital display flash.
- Negative Overrange:** First segment of bargraph and bottom segments of digital display flash.
- Relay Output:** Two 4 Amp Form A relays and Two 9 Amp Form C relays.
- Analog Output:** Isolated 16 bit user scalable mA or V
OIC (mA out) 4-20 mA @ 0 to 500 Ω max loop resistance
OIV (volts out) 0-10 V DC @ 500 Ω or higher resistance
- Power Supply:** AC/DC Auto sensing wide range supply
PS1 (std) **85-265 VAC / 95-300 VDC, 50-400Hz 4.2W**
PS2 18-48 VAC / 10-72 VDC, 50-400Hz 4.2W
- Operating Temp.:** 0 to 50 $^{\circ}$ C
- Storage Temp.:** -20 $^{\circ}$ C to 70 $^{\circ}$ C
- Relative Humidity:** 95% (non condensing)
- Case Dimensions:** 9/64 DIN (Bezel 36Wx144Hmm)
Depth behind bezel (5.83") 148mm
Plus (0.7") 18mm for connectors
- Weight:** 9.5 oz., 12 oz when packed

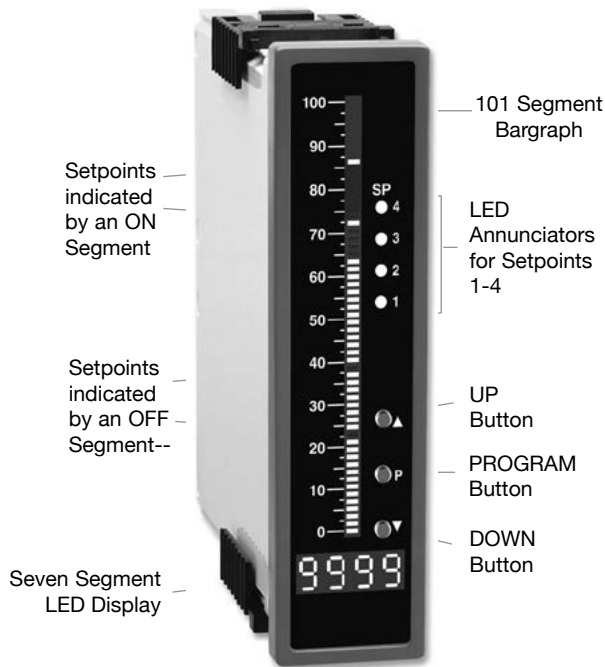

Index

Bargraph Center Point Display Mode Selection . . .	6	Digital Span Selection for Display	5	Programming Conventions.	2
Bargraph Color Programming Mode	9	Digital Span Selection for Analog Range Output. . .	6	Setpoint Setting & Relay Configuration Mode. . .	8-9
Case Dimensions	7	Functional Diagram	10	Software Features	1
Component Layout.	11	General Features	1	Software Logic Tree	3
Connector Pinouts	10	I-Series Input Signal Conditioning Modules . . .	12-15	Specifications.	1
Connectors.	11	Input Module Calibration Procedures	17	Standard Faceplates and Scales.	18
Controls and Indicators	2	Input Module Component Glossary.	16	Two Point Analog Range Setting & Calibration . . .	7
Custom Faceplates and Scales.	19	Ordering Information	20	Two Point Digital Calibration Mode	4
Decimal Point and Brightness Selection	5	Pin Descriptions	10		





Front Panel Buttons

Program Button

The  button is used to move from one program step to the next. When pressed at the same time as the  button, it initiates the **calibration mode**. When pressed at the same time as the  button, it initiates the **setpoint setting mode**.

Up Button

When in the operational display, pressing the  button allows you to view the setting of the saved **Peak and Valley Values**.

When setting a displayed parameter during programming, the  button is used to increase the value of the displayed parameter.

Down Button

When in the operational display, pressing the  button allows you to change the **Brightness Level** as well as to view the setting of the setpoints **SP1, SP2, SP3 & SP4**.

When setting a displayed parameter during programming, the  button is used to decrease the value of the displayed parameter.

Front Panel LED Display

Annunciator LEDs

The annunciator LEDs indicate the alarm status. They are labeled from bottom to top: SP1, SP2, SP3, SP4.

Digital LED Displays

The digital LED displays are used to display the meter input signal readings. They also display the programming settings during programming.

Setpoint Indication

The position of setpoints on the bargraph display are indicated by an ON or OFF segment dependent on the bargraph display being above or below the setpoint.

Programming Conventions

To explain software programming procedures, logic diagrams are used to visually assist in following the programming steps. The following symbols are used throughout the logic diagrams to represent the buttons and indicators on the meter:



This symbol represents the OPERATIONAL DISPLAY.



This is the PROGRAM button.



This is the UP button.



This is the DOWN button.

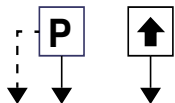

When a button is shown, press and release it to go onto the next step in the direction indicated by the arrow. When an alternative dotted line is shown, this indicates that an alternative logic branch will be followed when a particular option is present.

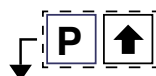



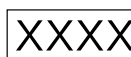

When two buttons are shown side by side and enclosed by a dotted line, they must be pressed at the same time then released to go onto the next programming step.







If an X appears through a digit, it means that any number displayed in that digit is not relevant to the function being explained.



When the  and  buttons are shown together, the display value can be increased by pressing and releasing the  button or decreased by pressing and releasing the  button.



When the  and  buttons are shown with two displays, either display can be selected by pressing and releasing the  or  buttons.

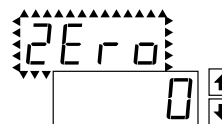

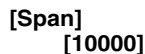

When two displays are shown together with bursts, this indicates that the display is toggling (flashing) between the name of the function and the value.

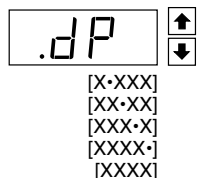

Text or numbers shown between square brackets in a procedure indicate the programming code name of the function or the value displayed on the meter display.



When there are more than two display selections they are shown in brackets below the first display and are also selectable by pressing and releasing the  or  buttons.

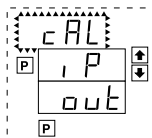

A dotted line enclosing an entire logic diagram indicates that programming branch will appear only when a particular option is present.

The FL-BDPSF-PROCESS is an intelligent bargraph meter with a hierarchical software structure designed for easy programming and operation, as shown below in the software logic tree.

Software Version is Displayed on Power-up

When power is applied, all segments of the bargraph and digital display light up for 3 seconds. The version number of the installed software is then displayed for 2 seconds, after which, the operational display indicates the input signal.

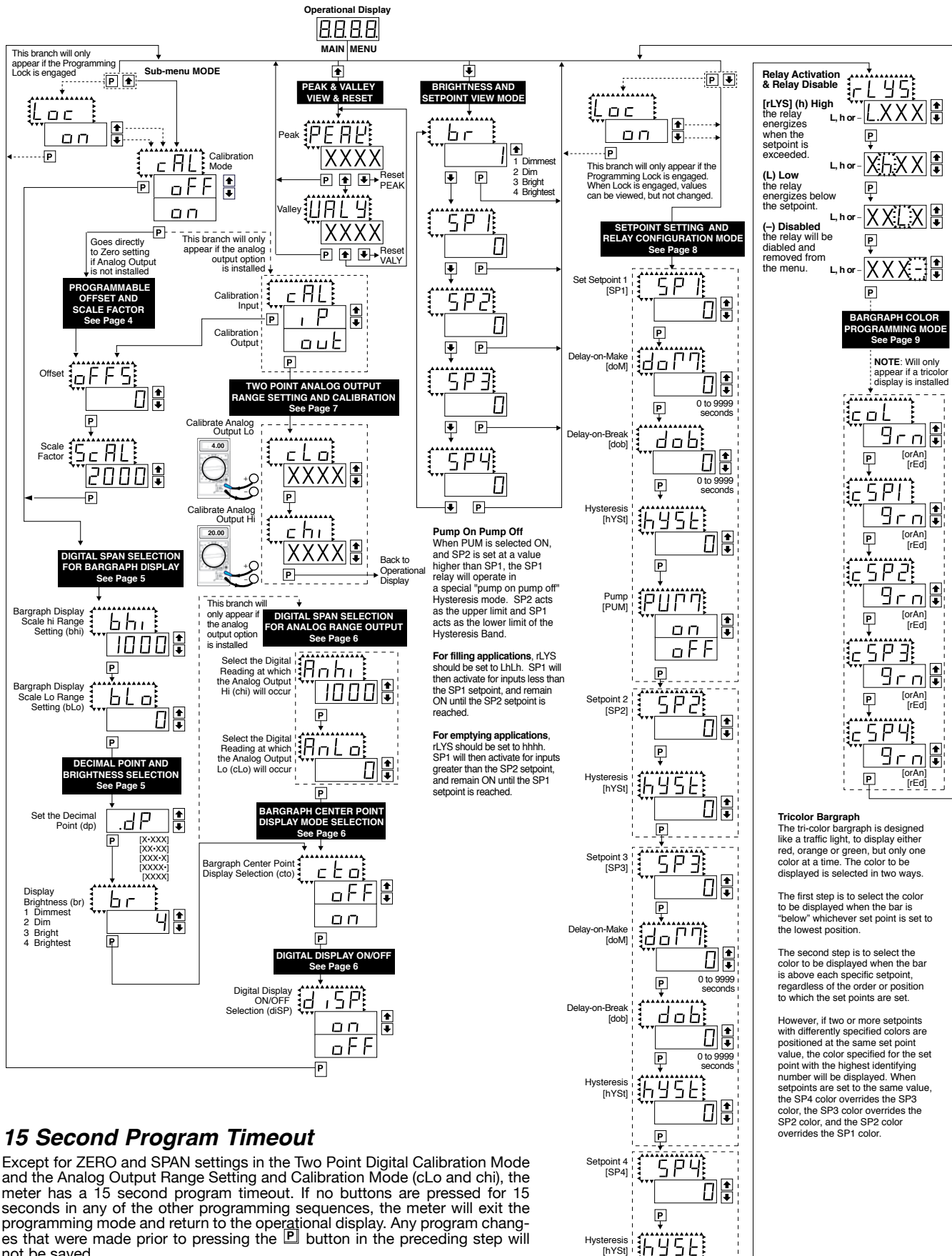

15 Second Program Timeout

Except for ZERO and SPAN settings in the Two Point Digital Calibration Mode and the Analog Output Range Setting and Calibration Mode (cLo and chi), the meter has a 15 second program timeout. If no buttons are pressed for 15 seconds in any of the other programming sequences, the meter will exit the programming mode and return to the operational display. Any program changes that were made prior to pressing the **P** button in the preceding step will not be saved.

Digital Rescaling

The FL-BDPSF-PROCESS meter may be rescaled without applying an external signal by changing the Offset and Scale factor.

Offset is the reading that the meter will display for a zero input. The Offset may be set to any value from -1999 to +9999. The default value of the Offset is 000

Scale factor is the gain of the meter. The displayed reading is directly proportional to the Scale factor. The default value of the scale factor is 2000, but it may be set to any value between -1999 and +9999.

For an input of 2V a calibrated meter will read 2000 with the default Scale factor of 2000, 3000 with a Scale factor of 3000 and 500 with a Scale factor of 500

If a linear scale is represented by $mx + b$, then the Scale Factor corresponds to the slope 'm' and the Offset corresponds to the intercept 'b'

The internal Signal Span is limited to 3 V DC between - 1 V DC to + 2 V DC. Outputs from an Input Signal Conditioning module that exceed these limits will cause the meter to indicate overrange.

Note: Most input signal conditioners have provisions for analog calibration and scaling. If the meter's digital Scale Factor is set to 2000 and Offset set to 0000 then, any pre-calibrated signal conditioner with an output that does not exceed - 1 V to + 2 V, will read correctly in the meter without any further calibration.

Digital Rescaling Procedure

STEP A Enter the Calibration Mode

- 1) Press the **[P]** and **[↑]** buttons at the same time. Display toggles between [CAL] and [oFF].
- 2) Press the **[↑]** or **[↓]** button. Display changes from [oFF] to [on].
- 3) Press the **[P]** button. Display toggles between [CAL] and [out].

Note: If at this point, the display skips directly to STEP C and toggles between [SPAN] and the previous [SPAN] setting, the software is detecting that the optional analog output hardware is NOT installed.

STEP B Select Two Point Digital Calibration of Input Signal

- 1) Press the **[↑]** or **[↓]** button to select CAL [iP] for input signal calibration.
- 2) Press the **[P]** button. Display toggles between [oFFS] and the previous offset setting.

STEP C Set the Offset on the Digital Display

- 1) Using the **[↑]** and **[↓]** buttons, adjust the digital display to the desired offset. This is the reading that the meter will display for a zero input
- 2) Press the **[P]** button. Display toggles between [ScAL] and the previous Scale factor.

STEP D Set the Scale factor on the Digital Display

- 1) Using the **[↑]** and **[↓]** buttons, adjust the meter display to the desired Scale factor. The default value is 2000, for which a 2V input will read 2000. If the scale factor is changed the display will change proportionately. Therefore if the Scale factor is changed to 1000 then for the same 2V input the display would read 1000.
- 2) Press the **[P]** button.

The Digital Rescaling is now complete.

If the Digital Rescaling was successfully completed, the menu branches to the Digital Span Selection for Bargraph Display (see page 6), and the display flashes [bhi] and the previous setting.

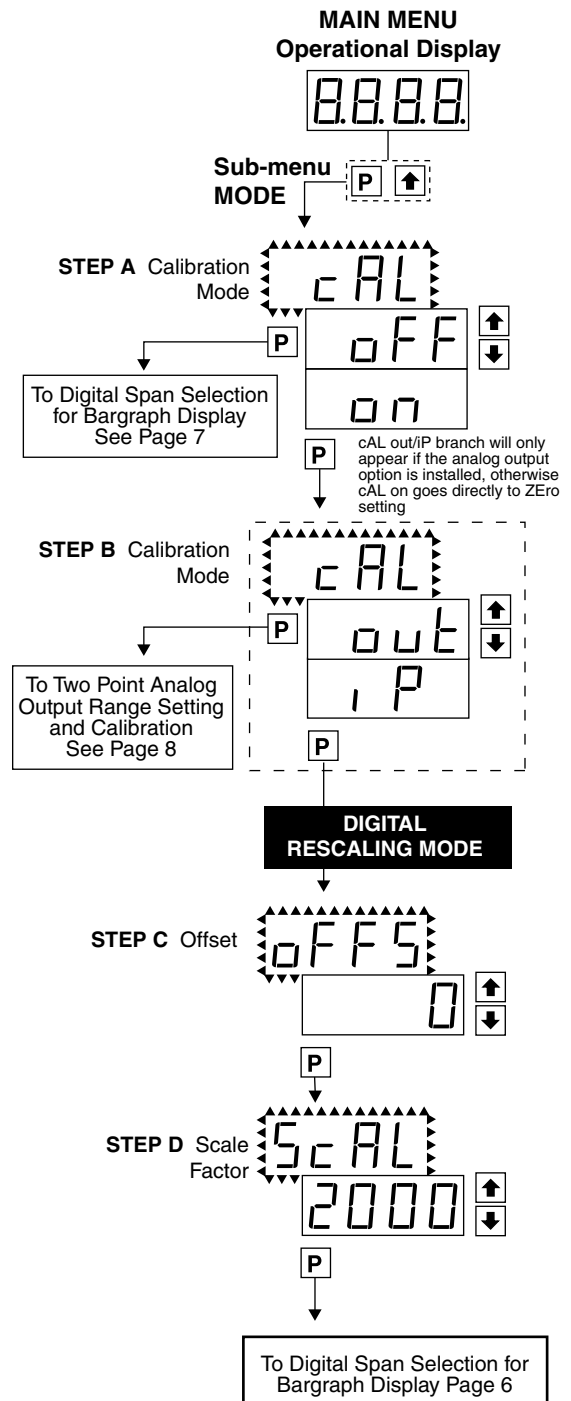

Digital Span Selection For Bargraph Display

The bargraph can be set to display full scale (0-101 bars) any portion of the digital reading from a minimum of 100 counts to a maximum of 12,000 counts. This provides higher resolution bargraph indication for those applications where the normal operating input signal range is less than the desired full scale display range of the digital display.

For Example:

If the full scale range of the meter has been set from -1999 to 9999 (0-12,000 counts), but the normal operating range of the input signal is between 4000 & 6000. The bargraph high parameter [bhi] can be set to 6000 and the bargraph low parameter [bLo] can be set to 4000.

This means that although the meter could digitally display a signal from -1999 to 9999 (0-12,000 counts), the bargraph display only begins to function at a reading of 4000, and reaches full scale indication at a reading of 6000. Although the digital display will continue reading up to 9999 before indicating overrange, the bargraph display will indicate its overrange by flashing for readings above 6000.

Example of Setting the Digital Span of the Bargraph Display to be Different than the Digital Display Range

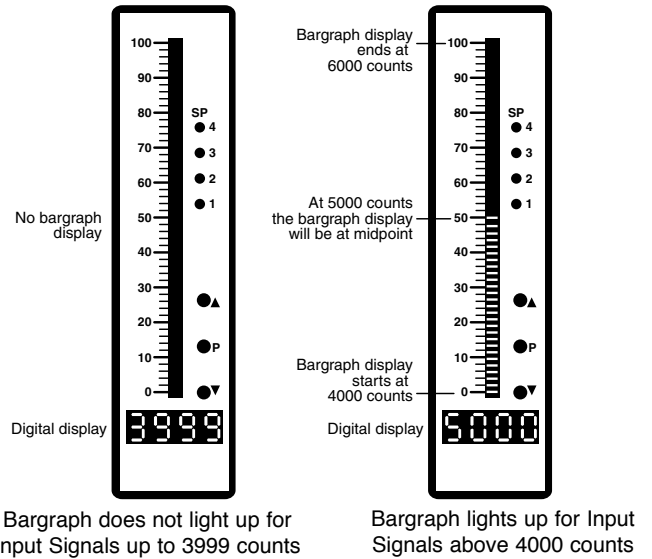

STEP A Enter the Calibration Sub Menu Mode

- 1) Press the **[P]** and **[↑]** buttons at the same time. Display toggles between [CAL] and [oFF].
- 2) Press the **[P]** button. Display toggles between [bhi] and the previous setting.

STEP B Set the Digital Span of the Bargraph Display (See example above)

- 1) Using the **[↑]** and **[↓]** buttons, adjust the display to the desired high parameter reading, e.g. 6000 counts.
- 2) Press the **[P]** button. Display toggles between [bLo] and the previous setting.
- 3) Using the **[↑]** and **[↓]** buttons, adjust the display to the desired low parameter reading, e.g. 4000 counts.
- 4) Press the **[P]** button. Display changes from [4000] to [dP].

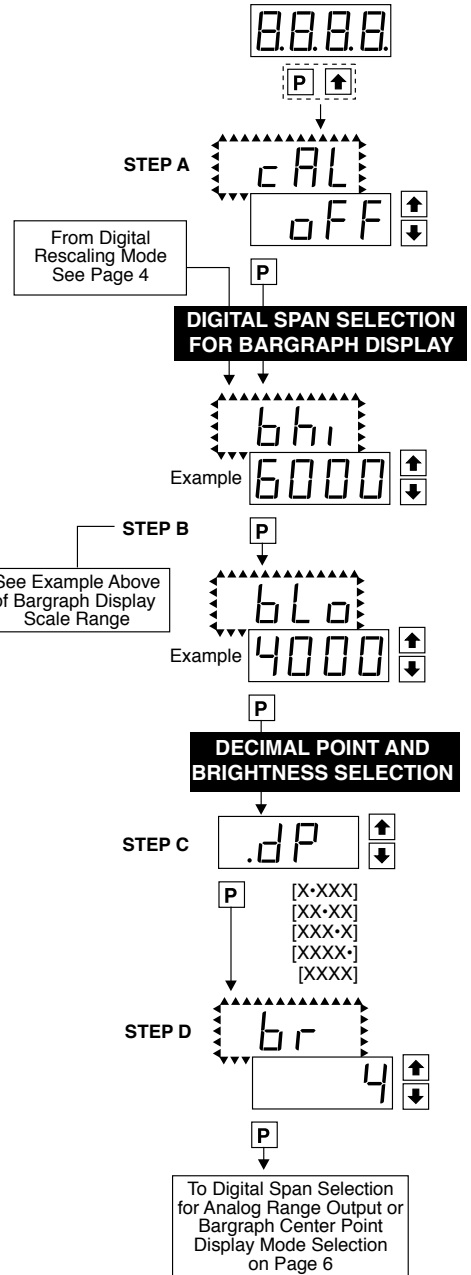

Decimal Point and Brightness Selection

STEP C Set the Decimal Point

- 1) Using the **[↑]** and **[↓]** buttons, adjust the display to the desired decimal point setting.
- 2) Press the **[P]** button. Display toggles between [br] and the previous brightness setting.

STEP D Set the Bargraph and Digital Display Brightness

- 1) Using the **[↑]** and **[↓]** buttons, adjust the display to the desired brightness setting (4 is the brightest setting).
- 2) Press the **[P]** button. Display toggles between [Anhi] and the previous [Anhi] setting.

Note: If at this point, the display skips directly to STEP G and toggles between [Cto] and [oFF], the software is detecting that the optional analog output hardware is NOT installed.

Digital Span Selection for Analog Range Output

STEP E Selecting the [Anhi] Digital Value for Analog High Output

- Using the \uparrow and \downarrow buttons, adjust the display to the desired digital value at which the [chi] Calibrated Analog High output will occur. For digital readings outside the digital span selected, the analog output will linearly rise above the value set for chi, up to the maximum analog output capability. However, the analog output will not go lower than the calibrated value set for cLo (see below).
- Press the P button. Display toggles between [AnLo] and previous [AnLo] setting.

STEP F Selecting the [AnLo] Digital Value for Analog Low Output

- Using the \uparrow and \downarrow buttons, adjust the display to the desired digital value at which the [cLo] Calibrated Analog Low output will occur. For Digital readings outside the Digital Span selected, the analog output will not go lower than the calibrated value set for cLo.
- Press the P button. The display toggles between [cto] and [oFF].

Note: Any two digital span points from -1999 to 9999 can be selected. The digital values for [Anhi] analog high and [AnLo] analog low can be reversed to provide a 20 to 4mA output. The digital span selected can be as small as two counts, when using the analog output to function as a Control or Alarm Driver. Small digital spans will cause the high resolution 16 bit D to A to increment digitally in stair case steps.

See Two Point Analog Output Range Setting and Calibration at the top of the next page.

Bargraph Center Point Display Mode Selection

Example of Using the Center Point Bargraph Display Mode with a Unipolar Input

If the meter's full scale range is set to 5000 counts, the midpoint would be 2500 counts. If a signal of 2500 counts is applied only one segment at the 2500 count mark will light up. If a signal of 4000 counts is applied the segments between the center segment (2500 counts) and the 4000 count mark light up.

If a signal of 1000 counts is applied, the segments between the center segment (2500 counts) and the 1000 count mark will light up.

Example of Using the Center Point Bargraph Display Mode with Bipolar Signal Inputs

The meter may also be calibrated to display symmetrical bipolar signals such as ± 1 V or ± 10 V. When the center point display mode is selected, it will then function as a center zero meter. When positive signals are applied, the bar will go up from the center point, and when negative signals are applied, the bar will go down from the center point.

STEP G Bargraph Center Point Mode Selection (See example above)

- To select bargraph center point mode, press the \uparrow or \downarrow button. Display changes from [oFF] to [on].
- Press the P button. Display toggles between [diSP] and [on] or [oFF].

STEP H Digital Display ON/OFF Selection

- To set the display to [oFF], press the \uparrow or \downarrow button. Display toggles between [diSP] and [oFF].
- Press the P button. The display exits the calibration mode and returns to the operational display. Only the bargraph display is on and the digital display is off.

If the digital display is selected to be off, pressing any button to make programming changes or to view setpoints activates the digital display. When the procedure is complete, the digital display will then automatically switch off.

The Display/Bargraph settings are now complete.

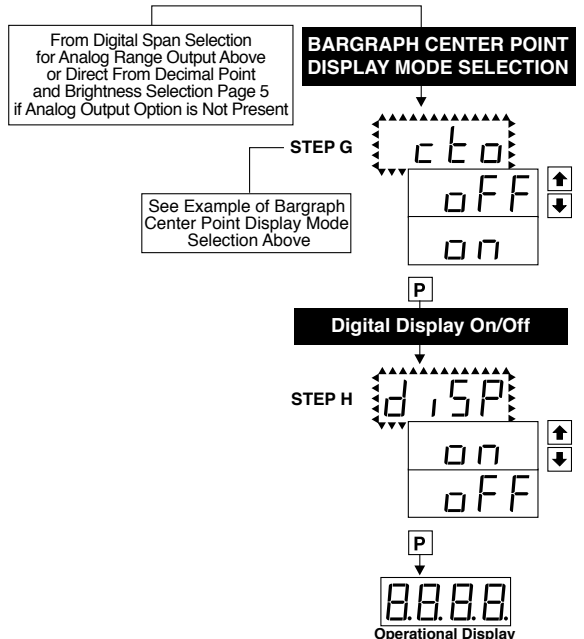
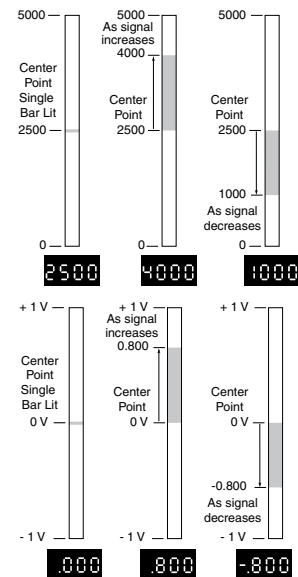
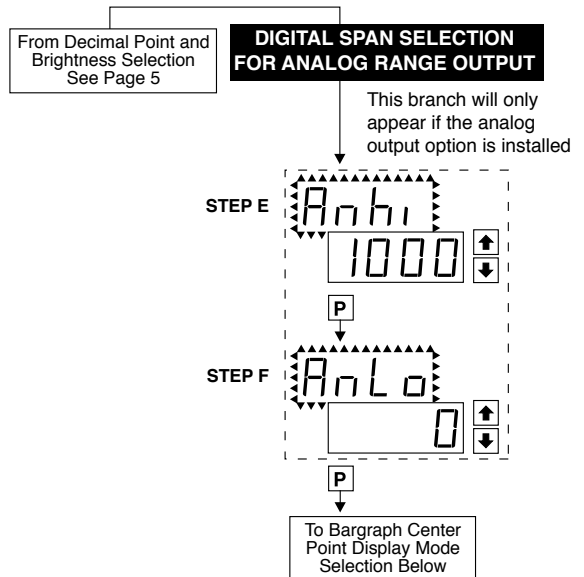

Two Point Analog Output Range Setting and Calibration

Determine if the Analog Output Selection Header is in the 4 to 20mA (0-20mA) position or the 0 to 10VDC position. If necessary, the module may have to be removed and the header position changed (see Component Layout below).

Note: Always disconnect power from the meter before removing the analog output module to adjust the mA or Volts output selection header and reinstalling it. When power is reconnected, the meter's software will automatically detect the presence or absence of the analog output module.

STEP A Enter the Calibration Mode

- 1) Press the **[P]** and **[↑]** buttons at the same time. Display toggles between [cAL] and [oFF].
- 2) Press the **[←]** or **[→]** button. Display changes from [oFF] to [on].
- 3) Press the **[P]** button. Display toggles between [cAL] and [out] input calibration.

Note: If at this point the display skips directly to toggle between Zero and the previous Zero setting, the software is detecting that the optional analog output hardware is NOT installed.

STEP B Enter the Two Point Analog [ouT] Output Range Setting and Calibration Mode

- 1) Press the **[P]** button. Display toggles between [cLo] and an internal scale factor.

STEP E Set or Calibrate [cLo] the Low Analog Value of the Analog Output Range

- 1) Connect a multimeter to analog output pins 17 and 18 (see Rear Panel Pinouts on page 10). Using the **[←]** and **[→]** buttons, adjust the analog output to the desired low value as measured on the multimeter. cLo may be adjusted to any value from -0.3 mA to 18 mA (mA output selected) or from -0.6 V to 8 V (volt output selected). However, the output of cLo must always be less than the value selected for chi. If a reversed analog output is desired, the values selected to establish the Digital Span can be reversed (see top of page 6). For digital readings outside the Digital Span selected, the analog output will not go any lower than the calibrated value set for cLo. However, the analog output will linearly rise above the value set for chi, up to the maximum analog output capability (see chi below).
- 2) Press the **[P]** button. Display toggles between [chi] and an internal scale factor.

STEP F Set or Calibrate [chi] the High Analog Value of the Analog Output Range

- 1) Using the **[←]** and **[→]** buttons, adjust the analog output to the desired high value as measured on the multimeter display. chi may be adjusted to any value from 18 mA to 24 mA (mA output) or from 8 V to 10.3 V (volt output). However, the value must be higher than the value selected for cLo. For digital readings outside the Digital Span selected, the analog output will linearly rise above the value set for chi, up to the maximum analog output capability.
- 2) Press the **[P]** button. The meter exits the calibration mode and returns to the operational display.

Note: The analog output range established by the values selected for cLo and chi will occur, automatically scaled, between the two digital values selected for AnHi and AnLo. However, the analog output can linearly rise above the chi value set for digital readings outside the digital span selected. See Digital Span Selection on page 6.

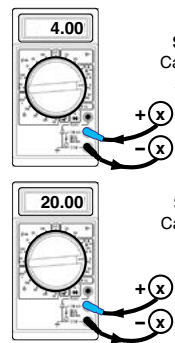
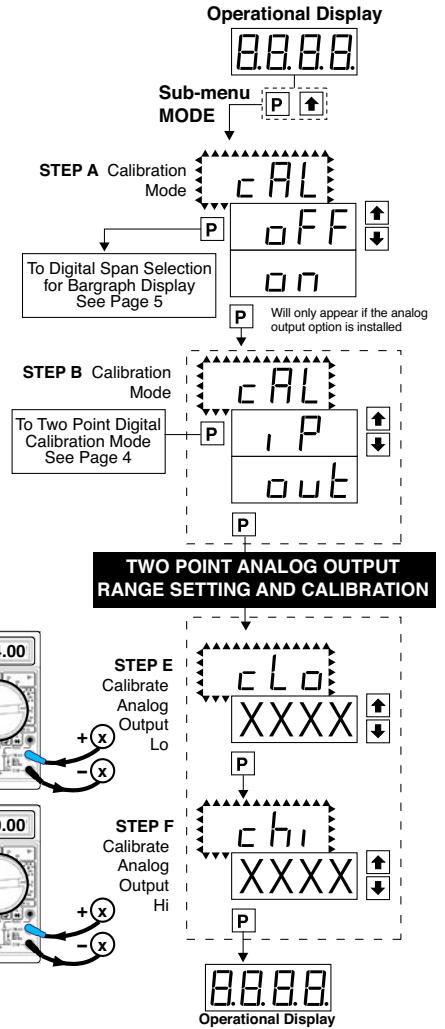

Case Dimensions

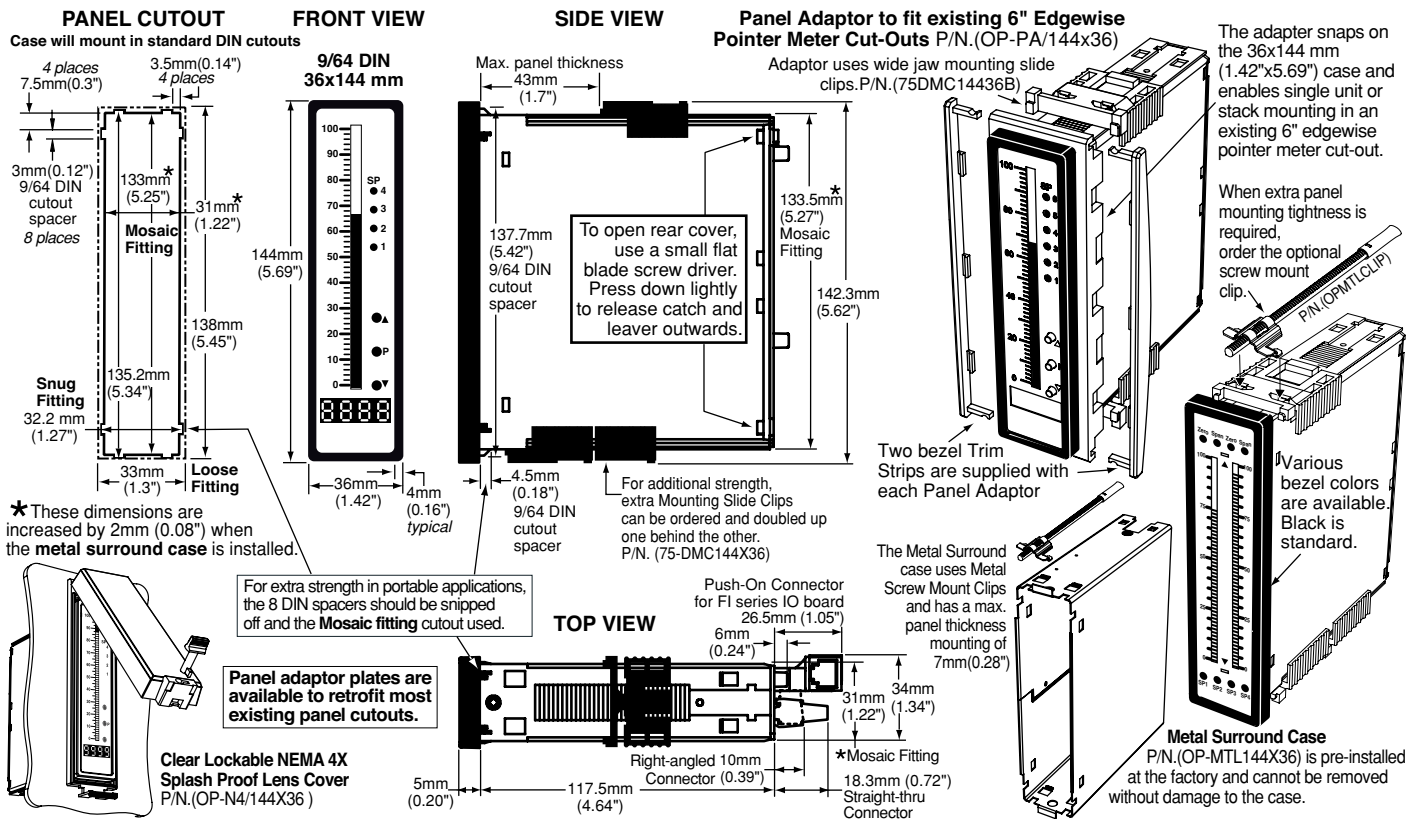

Setpoint Setting and Relay Configuration Mode

The following programming steps are required to enter the setpoint values and configure the relay functions in a meter with four relays using four setpoints. Generally if less than four relays are installed, the setpoints without relays are operational in software for tri-color control or display only purposes. To remove unwanted setpoint indications, set them to 9999 or -1999 depending on the relay activation mode selected.

STEP A Enter the Setpoint Mode

- 1) Press the **P** and **↓** buttons at the same time. Display toggles between [SP1] and the previous SP1 setting.

STEP B Set Setpoint 1 [SP1]

- 1) Using the **↑** and **↓** buttons, adjust the display to the desired SP1 value.
- 2) Press the **P** button. Display toggles between [doM] and the previous [doM] setting.

STEP C Set the SP1 Delay-on-Make [doM] Delay Time Setting

- 1) Using the **↑** and **↓** buttons, adjust the display to the desired [doM] value (0 to 9999 seconds). The reading must continuously remain in an alarm condition until this delay time has elapsed before the relay will make contact (energize).
- 2) Press the **P** button. Display toggles between [dob] and the previous [dob] setting.

STEP D Set the SP1 Delay-on-Break [dob] Delay Time Setting

- 1) Using the **↑** and **↓** buttons, adjust the display to the desired [dob] value (0 to 9999 seconds). The reading must continuously remain in a non-alarm condition until this delay time has elapsed before the relay will break contact (de-energize).
- 2) Press the **P** button. Display toggles between [hYSt] and the previous [hYSt] setting.

STEP E Select the Hysteresis [hYSt]

- 1) Using the **↑** and **↓** buttons, select the Hysteresis to be ON or OFF.
- 2) Press the **P** button. Display toggles between PUM and (on) or (oFF).

STEP F Select Pump [PUM] (on) or (oFF)

- 1) Using the **↑** and **↓** buttons, select the Pump to be ON or OFF. When PUM is selected ON, and SP2 is set at a value higher than SP1, the SP1 relay will operate in a special "pump on pump off" mode. SP2 acts as the upper limit and SP1 acts as the lower limit of the Hysteresis Band on the SP1 relay.

For filling applications:

[rLYS] should be set to [LhXX] (see step M). The SP1 relay and SP1 LED Annunciator will then activate for inputs less than the SP1 setpoint, and remain ON until the SP2 setpoint is reached.

For emptying applications:

[rLYS] should be set to [hhXX] (see step M). The SP1 relay and SP1 LED Annunciator will then activate for inputs greater than the SP2 setpoint, and remain ON until the SP1 setpoint is reached.

- 2) Press the **P** button. Display toggles between [SP2] and the previous SP2 setting.

STEP G Set Setpoint 2 (SP2)

- 1) Using the **↑** and **↓** buttons, adjust the display to the desired SP2 value.
- 2) Press the **P** button. Display toggles between [hySt] and the previous [hySt] setting.

STEP H Select the Hysteresis [hYSt]

- 1) Using the **↑** and **↓** buttons, select the Hysteresis to be ON or OFF.
- 2) Press the **P** button. Display toggles between [SP3] and the previous [SP3] setting.

STEP I Set Setpoint 3 (SP3) (No [doM] or [dob])

- 1) Using the **↑** and **↓** buttons, adjust the display to the desired SP3 value.
- 2) Press the **P** button. Display toggles between [hySt] and the previous [hySt] setting.

STEP J Select the Hysteresis [hYSt]

- 1) Using the **↑** and **↓** buttons, select the Hysteresis to be ON or OFF.
- 2) Press the **P** button. Display toggles between [SP4] and the previous [SP4] setting.

STEP K Set Setpoint 4 (SP4) (No [doM] or [dob])

- 1) Using the **↑** and **↓** buttons, adjust the display to the desired SP4 value.
- 2) Press the **P** button. Display toggles between [hySt] and the previous [hySt] setting.

STEP L Select the Hysteresis [hYSt]

- 1) Using the **↑** and **↓** buttons, select the Hysteresis to be ON or OFF.
- 2) Press the **P** button. Display toggles between [rLYS] and the previous relay setting.

Please Continue On Next Page.

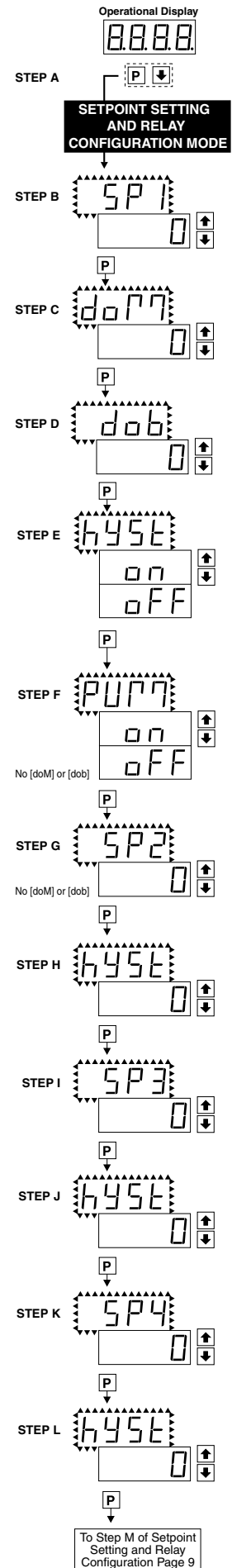

Setpoint Setting and Relay Configuration Mode Continued

STEP M Set Relay Activation mode [rLYS] for SP1

(h) High the relay energizes when the setpoint is exceeded. (L) Low the relay energizes below the setpoint. The setpoint is indicated from left to right SP1, SP2, SP3, SP4.

- Using the and buttons, select (L) or (h) for the first digit, which corresponds to SP1.
- Press the button. The SP2 Relay Activation digit begins to flash, and its decimal point is lit.

STEP N Set High (h) or Low (L) for SP2

- Using the and buttons, select (L) or (h) for the second digit, which corresponds to SP2.
- Press the button. The SP3 Relay Activation digit begins to flash, and its decimal point is lit.

STEP O Set High (h) or Low (L) for SP3

- Using the and buttons, select (L) or (h) for the third digit, which corresponds to SP3.
- Press the button. The SP4 Relay Activation digit begins to flash, and its decimal point is lit.

STEP P Set High (h) or Low (L) for SP4

- Using the and buttons, select (L) or (h) for the fourth digit, which corresponds to SP4.
- Press the button.

If a mono-color red or green display is installed then the Setpoint Relay Programming Mode is now complete and the meter returns to the operational display.

If a tricolor bargraph display is installed then the Bargraph Color Programming Mode will be entered and display toggles between [CoL] and the previous setting. Color selection menu will be displayed.

Bargraph Color Programming Mode

To comply with the latest safety requirements, the tri-color bargraph is designed like a traffic light, to display either red, orange or green, but only one color at a time. When the bar reaches a selected color change point, the entire bar will change to the color designated for that zone. This eliminates any ambiguity as to the signal status, especially just after transitioning to a new zone.

First (Step Q) is to select the color to be displayed, when the bar is “below*”, whichever set point is set to the lowest position.

Second (Steps R, S, T, and U) is to select the color to be displayed when the bar is above each specific set point, regardless of the order or position to which the set points are set.

However, if two or more setpoints with differently specified colors are positioned at the same set point value, the color specified for the set point with the highest identifying number will be displayed. When set points are set to the same value, the SP4 color overrides the SP3 color, the SP3 color overrides the SP2 color, and the SP2 color overrides the SP1 color.

STEP Q Select Bargraph Color when the bar is BELOW* the Setpoint that is set to the lowest position

- Using the and buttons, select the desired bargraph color [grn], [oran] or [red]
- Press the button. Display toggles between [CSP1] and the previous color setting.

STEP R Select Bargraph Color when the bar is ABOVE* SP1 Setpoint

- Using the and buttons, select the desired bargraph color [grn], [oran] or [red]
- Press the button. Display toggles between [CSP2] and the previous color setting.

STEP S Select Bargraph Color when the bar is ABOVE* SP2 Setpoint

- Using the and buttons, select the desired bargraph color [grn], [oran] or [red]
- Press the button. Display toggles between [CSP3] and the previous color setting.

STEP T Select Bargraph Color when the bar is ABOVE* SP3 Setpoint

- Using the and buttons, select the desired bargraph color [grn], [oran] or [red]
- Press the button. Display toggles between [CSP4] and the previous color setting.

STEP U Select Bargraph Color when the bar is ABOVE* SP4 Setpoint

- Using the and buttons, select the desired bargraph color [grn], [oran] or [red]
- Press the button. The meter exits the setpoint mode and returns to the operational display.

The Bargraph Color programming mode is now complete.

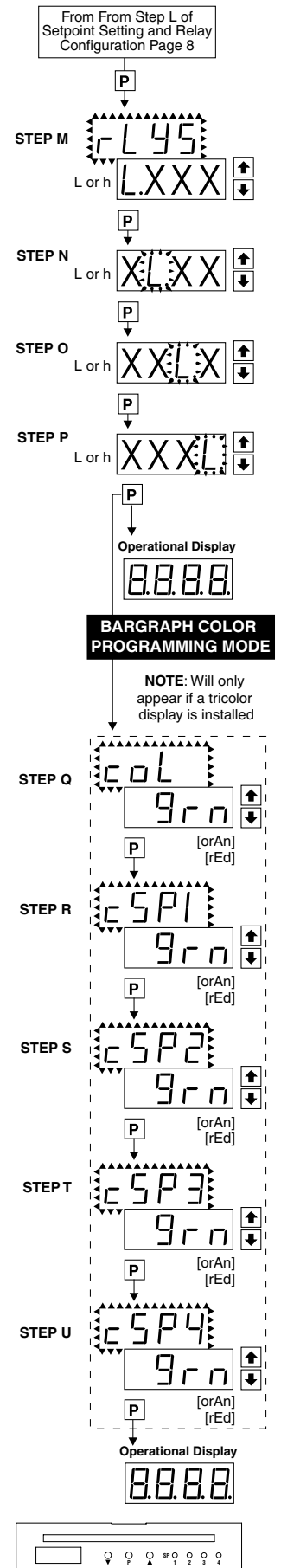

***Note:** For horizontal display formats BELOW* should be read as, “to the left” and ABOVE* should be read as, “to the right”.

Connector Pinouts

This meter uses plug-in type screw terminal connectors for all input and output connections. The power supply connections (pins 23 and 24) have a unique plug and socket outline to prevent cross connection. The main board uses standard right-angled connectors.

Replacement 2-, 3-, and 4-pin plug connectors are available (see Accessories on page 20).

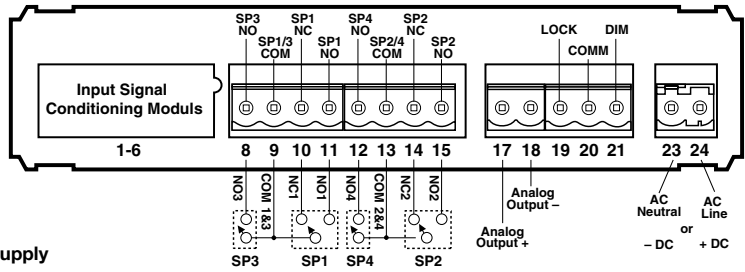

WARNING: AC and DC input signals and power supply voltages can be hazardous. Do Not connect live wires to screw terminal plugs, and do not insert, remove or handle screw terminal plugs with live wires connected.

Note: The sequence of setpoint outputs is now 3-1-4-2, enabling delay on make (dom) and delay on break (dob) to be used with both Form "C" relays.

Pin Descriptions

Pins 1 to 6 – Input Signal

Pins 1 to 6 are reserved for the input signal conditioner. See the data sheet for the selected input signal conditioner.

Pins 8 to 15 – Relay Output Pins

- Pin 8** SP3 NO. Normally Open 4 Amp Form A.
- Pin 9** SP1/3 COM. Common for SP1 and SP3.
- Pin 10** SP1 NC. Normally Closed 9 Amp Form C.
- Pin 11** SP1 NO. Normally Open 9 Amp Form C.
- Pin 12** SP4 NO. Normally Open 4 Amp Form A.
- Pin 13** SP2/4 COM. Common for SP2 and SP4.
- Pin 14** SP2 NC. Normally Closed 9 Amp Form C.
- Pin 15** SP2 NO. Normally Open 9 Amp Form C.

Pins 17 to 21 – Rear Panel Switches

- Pin 17** ANALOG OUTPUT (+). mA (0 to 20 mA/4 to 20 mA) or V (0 to 10 V) output is header selectable.
- Pin 18** ANALOG OUTPUT (-). mA (0 to 20 mA/4 to 20 mA) or V (0 to 10 V) output is header selectable.
- Pin 19** Programming LOCK. By connecting the LOCK pin to the COMMON pin, the meter's programmed parameters can be viewed but not changed.
- Pin 20** COMMON. To activate the LOCK or DIM functions from the rear of the meter, the respective pins have to be connected to the COMMON pin. This pin is connected to the internal power supply ground.
- Pin 21** DIM. By connecting the display dim (DIM) pin to the COMMON pin, the display brightness setting is halved.

Pins 23 and 24 – AC/DC Power Input

Auto-sensing AC/DC power supply. For voltages between 85-265 V AC / 95-300 V DC (PS1) or 18-48 V AC / 10-72 V DC (PS2).

- Pin 23** AC Neutral / -DC. Neutral power supply line.
- Pin 24** AC line / +DC. Live power supply line.

Connectors



WARNING

AC and DC input signals and power supply voltages can be hazardous. Do Not connect live wires to terminal blocks, and do not insert, remove or handle terminal blocks with live wires connected.

Standard plug-in screw terminal blocks provided by Texmate:

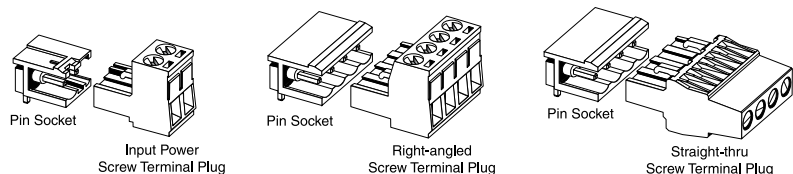

Component Layout

MAIN BOARD

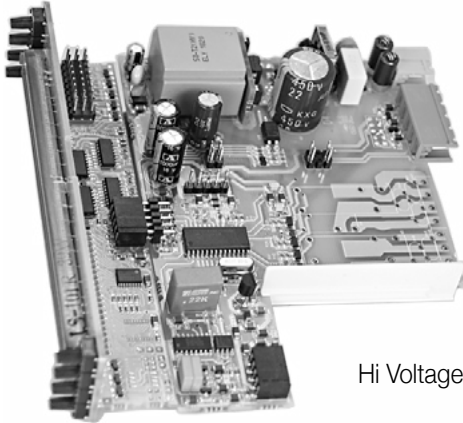

Hi Voltage

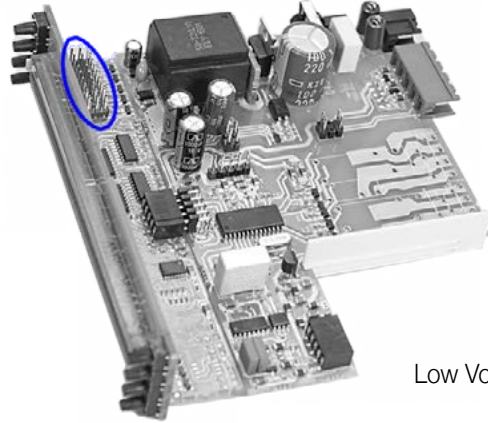

Low Voltage

4-20mA INPUT MODULE

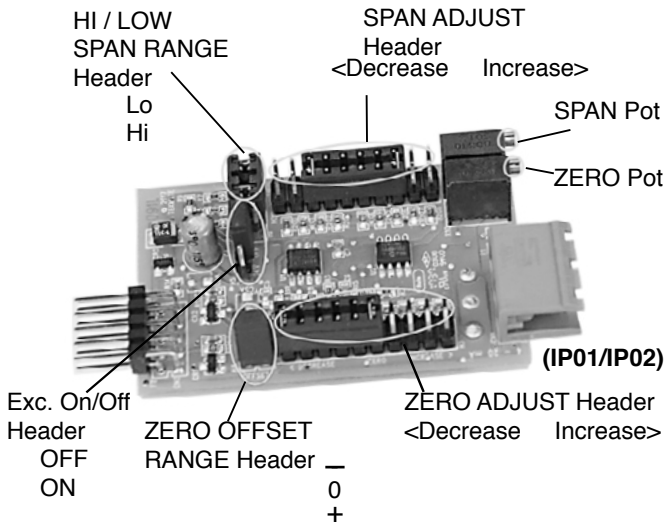

4 to 20mA Process Loop Measurement

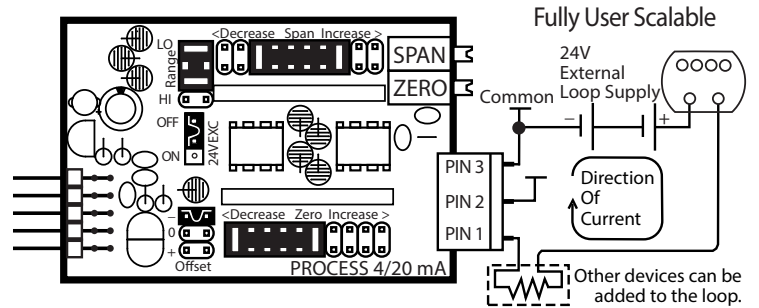

Order IP02, if you require the loop excitation voltage (24VDC@100mA) to be supplied by the meter.

0-10V INPUT MODULE

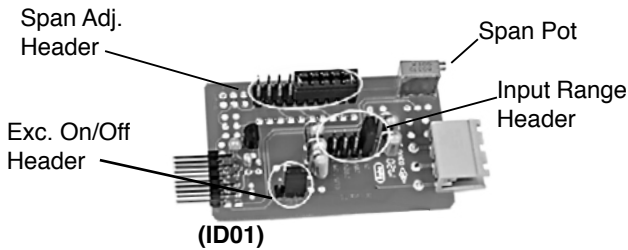

ID01: DC Volts, 2/20/200V/Custom w/24V DC Exc

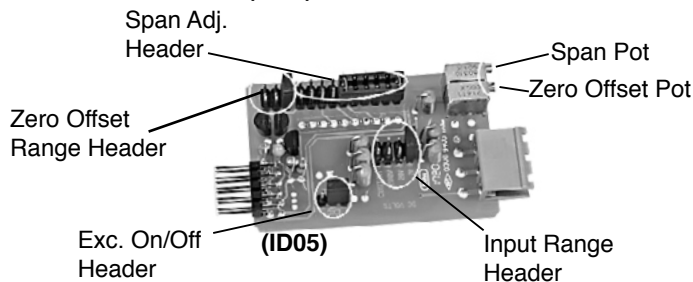
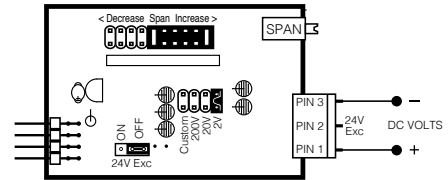

ID05: DC Volts 2/20/200/Custom V DC with Offset and 24V Exc.

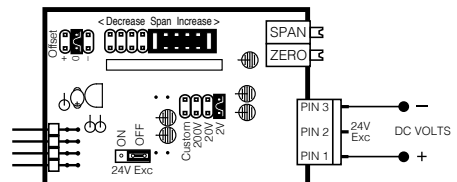

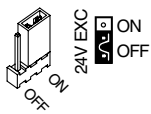

24V DC Output Header

On some modules this header enables a 24V DC 25mA (max) Excitation/Auxiliary output to be connected to Pin 2.

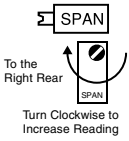

SPAN Potentiometer (Pot)

If provided, the 15 turn SPAN pot is always on the right side (as viewed from the rear of the meter). Typical adjustment is 20% of the input signal range.

SPAN ADJUST Header

This unique five-position header expands the adjustment range of the SPAN pot into five equal 20% steps, across 100% of the input Signal Span. Any input Signal Span can then be precisely scaled down to provide any required Digital Display span from 1999 counts to 001 (one count).

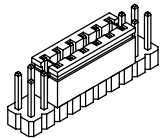

SPAN Adjust Header position	1	2	3	4	5
SPAN Pot %	20%	20%	20%	20%	20%
Signal Span %	20%	40%	60%	80%	100%

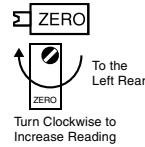
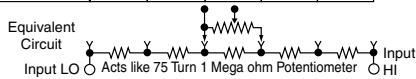

ZERO Potentiometer (Pot)

If provided, the ZERO pot is always to the left of the SPAN pot (as viewed from the rear of the meter). Typically it enables the input signal to be offset $\pm 5\%$ of full scale (-100 to +100 counts).

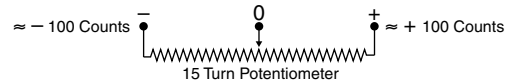

ZERO OFFSET RANGE Header

When provided, this three position header increases the ZERO pot's capability to offset the input signal, to $\pm 25\%$ of the digital display span. For example a Negative offset enables a 1 to 5V input to display 0 to full scale. The user can select negative offset, positive offset, or no offset (ZERO pot disabled for two step non-interactive span and offset calibration).

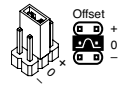

ZERO Pot%	- 100% of Offset	No Offset Zero Pot Disabled	+ 100% of Offset
Offset Range	$\oplus - 500$ Counts		$\oplus + 500$ Counts



SPAN RANGE Header

When this header is provided it works in conjunction with the SPAN ADJUST Header by splitting its adjustment range into a Hi and a Lo range. This has the effect of dividing the adjustment range of the SPAN pot into ten equal 10% steps across 100% of the input Signal Span.

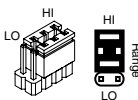

SPAN Adjust Header position	1	2	3	4	5	1	2	3	4	5
SPAN Pot %	10%	10%	10%	10%	10%	10%	10%	10%	10%	10%
Signal Span %	10%	20%	30%	40%	50%	60%	70%	80%	90%	100%

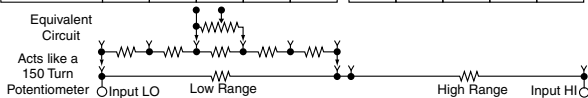

ZERO ADJUST Header

When this header is provided, it works in conjunction with the ZERO OFFSET RANGE Header, and expands the ZERO pot's offset capability into five equal negative steps or five equal positive steps. This enables virtually any degree of input signal offset required to display any desired engineering unit of measure.

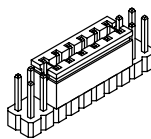

ZERO Adjust Header position	5	4	3	2	1	1	2	3	4	5
ZERO Pot %	-20%	-20%	-20%	-20%	-20%	+20%	+20%	+20%	+20%	+20%
Offset Range	-1200 or more counts					+1200 or more counts				

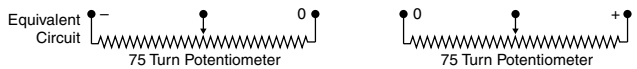

Fits 6" Edgewise Pointer Meter Cut-Outs

The adapter snaps on the 36x144 mm (1.42"x5.69") case and enables single unit or stack mounting in an existing 6" edgewise pointer meter cut-out.

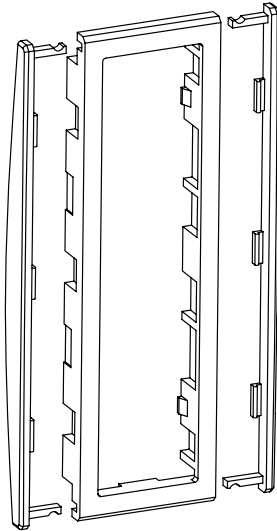

Panel Adapter
Part #: OP-PA/144X36

Fits existing cut-outs for 6" (150 mm) edgewise switchboard pointer meters from:

- Crompton
- G.E.
- Westinghouse
- Yokogawa
- and most others

Width: 43.7 mm to 48 mm (1.72" to 1.89")

Height: 143.4 mm to 149 mm (5.62" to 5.88")

Two bezel trim strips are provided with each adapter to finish off the edge of each individually mounted meter or the edge of each stack mounted array.

When extra panel mounting tightness is required, order the optional screw mount clip. P/N: OPMTLCLIP

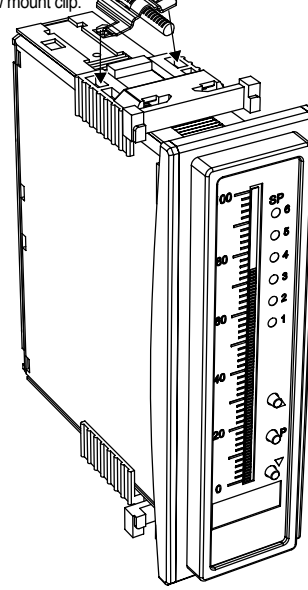

Adapter uses wide jaw mounting slide clips. P/N (75-DMC14436B)

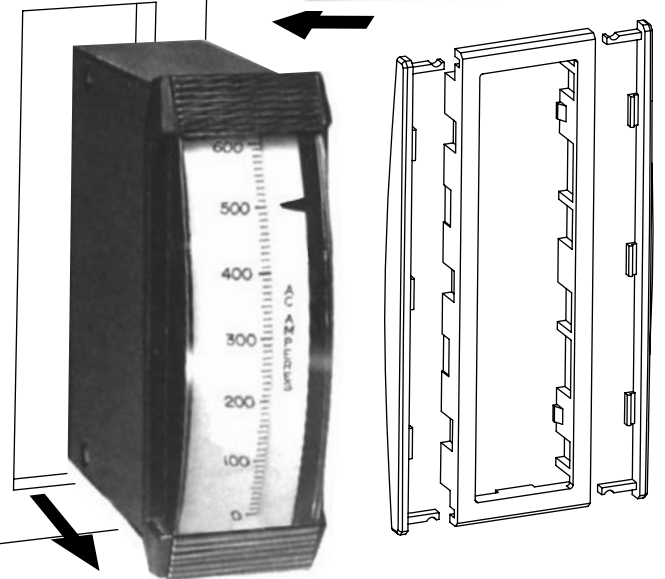
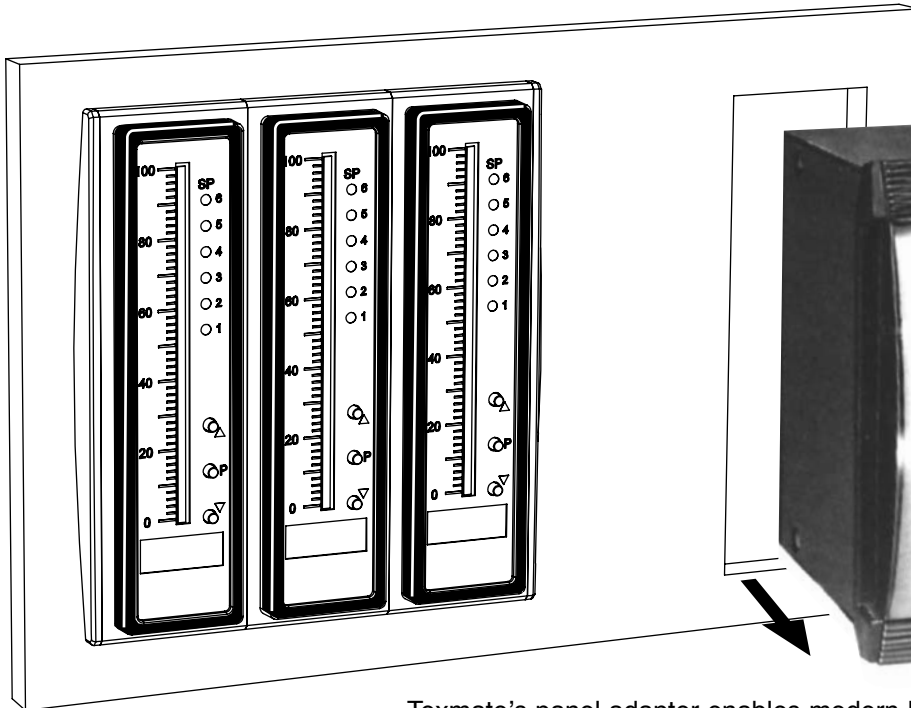
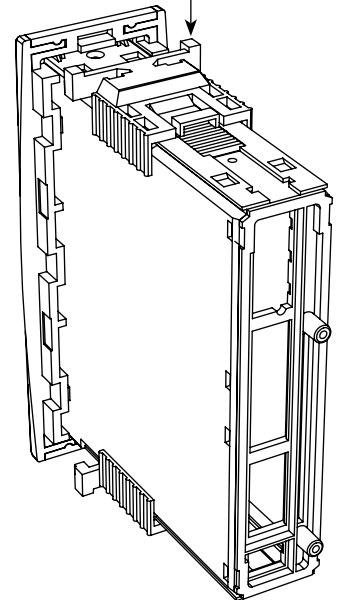

Texmate's panel adapter enables modern DIN meters to fit in existing cutouts individually or stacked when replacing old 6" edgewise mechanical pointer meters.

Custom Face Plates and Scales



Texmate Produces Thousands of Custom OEM Face Plates

Have Texmate Design and Build a Custom Face Plate to Suit your Next project!

- Custom face plates have a non-recurring artwork charge. A serial number is then assigned to each artwork, to facilitate re-ordering. We prefer custom logos and special artwork to be supplied in an Illustrator or Photoshop file format.
- Small Run or One-Off custom face plates incur an installation charge, and are generally printed on a special plastic film, which is then laminated to custom faceplate blanks as required.
- Large Run (300 pieces min): custom face plates are production silk screened, issued a part number, and held in stock for free installation as required by customer orders.
- OEMs may also order Custom Meter Labels, Box Labels Custom Data Sheets and Instruction Manuals.

Part Number	Description	List
-------------	-------------	------

Small Run Custom Face plates for Bargraphs

ART-NRC-DES . . .	Small run NRC custom faceplate design.	
ART-NRC-LOGO. . .	Small run NRC custom faceplate design with Co.Logo . .	
ART-FS1	Small run custom Faceplate - 1 color	
ART-FS2	Small run custom Faceplate - 2 color	
ART-FS3	Small run custom Faceplate - 3 color	
ART-FS4	Small run custom Faceplate - 4 color	
ART-FS5	Small run custom Faceplate - 5 color	
	Specify artwork serial number when ordering face plate installation. ie: AFB-XXXXX	

Large Run Custom Face plates for Bargraphs

ART-NRC-FILM. . .	Large run NRC custom faceplate design & films.	
ART-FPMAINT . . .	Inventory management fee for 2 years	
ART-FL1	Large run 300pcs custom faceplate - 1 color	
ART-FL2	Large run 300pcs custom faceplate - 2 color	
ART-FL3	Large run 300pcs custom faceplate - 3 color	
ART-FL4	Large run 300pcs custom faceplate - 4 color	
ART-FL5	Large run 300pcs custom faceplate - 5 color	

When ordering Large Run Face plates to be installed specify the custom part number issued for each different artwork. ie: 77-FLXXXX

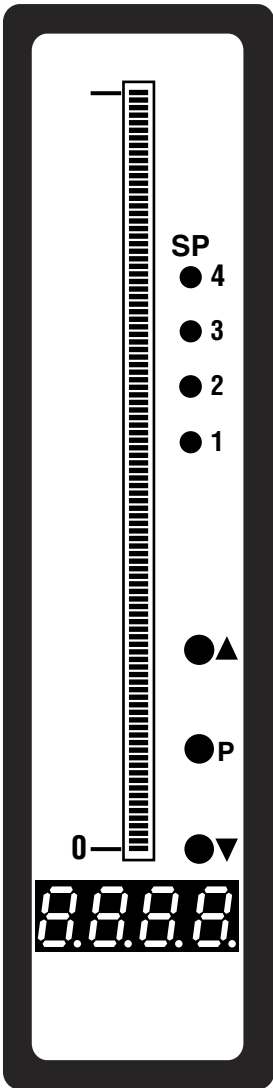

Face plate scales and numbers are shown close to their actual size

1	1.2	1.5	2	2.5	3	4	4.5	5	6	7.5	8	9
10	12	15	20	25	30	40	45	50	60	75	80	90
100	120	150	200	250	300	400	450	500	600	750	800	900
1000	1200	1500	2000	2500	3000	4000	4500	5000	6000	7500	8000	9000

10	12	15	20	25	30	40	45	50	60	75	80	90
9						35	40	45		70		80
8	10			20	25		35	40	50	60		70
7		12		15		30		35	40	50	60	70
6	8			20	25		30	35	40	50	60	70
5		9		15		25		30	40	50	60	70
4	6		10		15	20		25	30	40	50	60
3		10		15	20		25	30	40	50	60	70
2	8			20	25		30	35	40	50	60	70
1		12		15		25		30	40	50	60	70
0	6		10		15	20		25	30	40	50	60
		9		15		20		25	30	40	50	60
	4		10		15	20		25	30	40	50	60
		12		15		20		25	30	40	50	60
	3		10		15	20		25	30	40	50	60
		15		20		25		30	40	50	60	70
	2		15		20	25		30	40	50	60	70
		20		25		30		35	40	50	60	70
	1		20		25	30		35	40	50	60	70
		25		30		35		40	50	60	70	80
	0		25		30	35		40	50	60	70	80
		30		35		40		45	50	60	70	80
			30		35	40		45	50	60	70	80
		35		40		45		50	60	70	80	90
			35		40	45		50	60	70	80	90
		40		45		50		55	60	70	80	90
			40		45	50		55	60	70	80	90
		45		50		55		60	70	80	90	90
			45		50	55		60	70	80	90	90
		50		55		60		65	70	80	90	90
			50		55	60		65	70	80	90	90
		55		60		65		70	80	90	90	90
			55		60	65		70	80	90	90	90
		60		65		70		75	80	90	90	90
			60		65	70		75	80	90	90	90
		65		70		75		80	90	90	90	90
			65		70	75		80	90	90	90	90
		70		75		80		85	90	90	90	90
			70		75	80		85	90	90	90	90
		75		80		85		90	90	90	90	90
			75		80	85		90	90	90	90	90
		80		85		90		90	90	90	90	90
			80		85	90		90	90	90	90	90
		85		90		90		90	90	90	90	90
			85		90	90		90	90	90	90	90
		90		90		90		90	90	90	90	90
			90		90	90		90	90	90	90	90

10x5	6x2x2	5x3x2	4x5x2	5x5x2	6x5	8x5	9x5	10x5	6x5	7.5x5	8x5	9x5
Div. 50	24	30	40	50	30	40	45	50	30	37.5	40	45

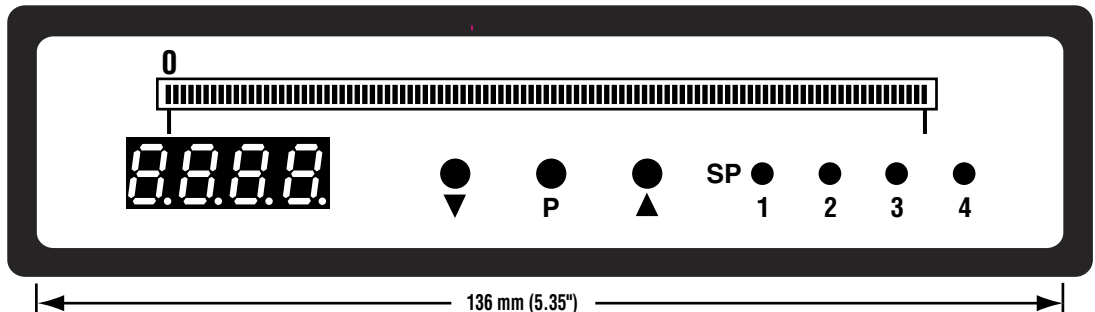

Installation

1. Install and wire meter per local applicable codes/regulations, the particular application, and good installation practices.
2. Install meter in a location that does not exceed the maximum operating temperature and that provides good air circulation.
3. Separate input/output leads from power lines to protect the meter from external noise. Input/output leads should be routed as far away as possible from contactors, control relays, transformers and other noisy components. Shielding cables for input/output leads is recommended with shield connection to earth ground near the meter preferred.
4. A circuit breaker or disconnect switch is required to disconnect power to the meter. The breaker/switch should be in close proximity to the meter and marked as the disconnecting device for the meter or meter circuit. The circuit breaker or wall switch must be rated for the applied voltage (e.g., 120VAC or 240VAC) and current appropriate for the electrical application (e.g., 15A or 20A).
5. See *Case Dimensions* section for panel cutout information.
6. See *Connector Pinouts* section for wiring.
7. Use 28-12 AWG wiring, minimum 90°C (HH) temperature rating. Strip wire approximately 0.3 in. (7-8 mm).
8. Recommended torque on all terminal plug screws is 4.5 lb-in (0.51 N-m).



Ordering Information

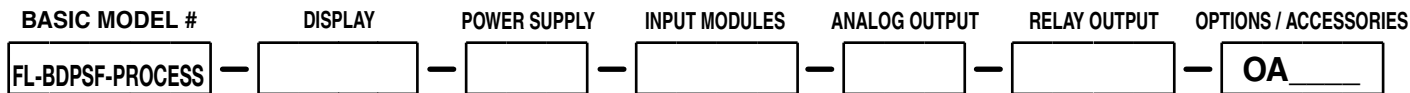

Add to the basic model number the order code suffix for each standard option required. The last suffix is to indicate how many different special options and or accessories that you may require to be included with this product.

Ordering Example: FL-BDPSF-PROCESS-VRR-PS1-IA01-OIC-R11-OA2 plus ZR and an OP-N4/144X36

► **BASIC MODEL NUMBER**

FL-BDPSF-PROCESS
 144x36mm 101 Seg Bargraph w/4 Digit Process input

Standard Options for this Model Number

Order Code Suffix	Description	List
-------------------	-------------	------

► **DISPLAY**

- VRR **Red LED Bargraph w/4 Digit Red DPM, Vertical.**
- VGG Green LED Bargraph w/4 Digit Green DPM, Vertical
- VGR Green LED Bargraph w/4 Digit Red DPM, Vertical
- VRG Red LED Bargraph w/4 Digit Green DPM, Vertical
- VTG Tri-Color Bargraph w/4 Digit Green DPM, Vertical
- VTR Tri-Color Bargraph w/4 Digit Red DPM, Vertical
- HRR Red LED Bargraph w/4 Digit Red DPM, Horizontal
- HGG Green LED Bargraph w/4 Digit Green DPM, Horizontal
- HGR Green LED Bargraph w/4 Digit Red DPM, Horizontal
- HRG Red LED Bargraph w/4 Digit Green DPM, Horizontal
- HTG Tri-Color Bargraph w/4 Digit Green DPM, Horizontal
- HTR Tri-Color Bargraph w/4 Digit Red DPM, Horizontal
- DSGG Dual Scale Green LED Vertical Bargraph w/4 Digit Green DPM
- DSGR Dual Scale Green LED Vertical Bargraph w/4 Digit Red DPM
- DSRG Dual Scale Red LED Vertical Bargraph w/4 Digit Green DPM
- DSRR Dual Scale Red LED Vertical Bargraph w/4 Digit Red DPM
- DSTG Dual Scale Tri-Color Vertical Bargraph w/4 Digit Green DPM
- DSTR Dual Scale Tri-Color Vertical Bargraph w/4 Digit Red DPM

► **POWER SUPPLY**

- PS1 **.85-265VAC/95-300VDC**
- PS2 15-48VAC/10-72VDC

► **INPUT MODULES (Partial List. See www.texmate.com)**

Unless otherwise specified Texmate will ship all modules precalibrated with factory preselected ranges and/or scalings as shown in **BOLD** type.

- IP01 **Process Loop, 4-20mA(0-100.00)**
- IP02 **Process Loop, 4-20mA(0-100.00) w/24VDC Exc**
- ID01 **DC-Volts, 2/20/200V/Custom w/24V DC Exc**
- ID05 **DC-Volts 2/20/200/Custom V DC w/Offset and 24V Exc.**

► **ANALOG OUTPUT**

- OIC Isolated 16 Bit Current Output, 4-20mA
- OIV Isolated 16 Bit Voltage Output, 0-10VDC

► **RELAY OUTPUT**

- R1 Single 4A Form A Relay
- R2 Dual 4A Form A Relays
- R11 Single 9A Form C Relay
- R12 Dual 9A Form C Relays
- R13 Dual 9A Form C & One 4A Form A Relays
- R14 Dual 9A Form C & Dual 4A Form A Relays
- R15 Single 9A Form C & Dual 4A Form A Relays
- R16 Single 9A Form C & Single 4A Form A Relays

Special Options and Accessories

Part Number	Description	List
-------------	-------------	------

► **SPECIAL OPTIONS (Specify Inputs or Outputs & Req. Reading)**

- ZR Calibrated Range Change to another Standard Range
- ZS Custom display scaling within standard ranges
- ZS-AO Custom scaling of analog output

► **ACCESSORIES (Specify Serial # for Custom Artwork Installation)**

- 75-DMC14436B Side Slide Brackets-Wide opening (2 pc)
- 75-DMC144X36 Side Slide Brackets-stand. (2 pc) - extra set
- 93-PLUG2P-DP Extra Screw Terminal Conn., 2 Pin Power Plug
- 93-PLUG2P-DR Extra Screw Terminal Conn., 2 Pin Plug
- 93-PLUG3P-DR Extra Screw Terminal Conn., 3 Pin Plug
- 93-PLUG4P-DR Extra Screw Terminal Conn., 4 Pin Plug
- 93-PLUG5P-DR Extra Screw Terminal Conn., 5 Pin Plug
- OP-MTL144x36 Metal Surround Case, includes screw mounting clips
- OP-MTLCLIP Screw Mounting Clips (2 pc) - to screw tighten slide brackets
- OP-N4/144X36 144x36mm clear lockable front cover-NEMA 4X, splash proof
- OP-PA/144X36 Panel Adapter for 144x36mm from 6 inch cutout

For Custom Face Plates and Scales see page 14.

Prices subject to change without notice.

WARRANTY

Texmate warrants that its products are free from defects in material and workmanship under normal use and service for a period of one year from date of shipment. Texmate's obligations under this warranty are limited to replacement or repair, at its option, at its factory, of any of the products which shall, within the applicable period after shipment, be returned to Texmate's facility, transportation charges pre-paid, and which are, after examination, disclosed to the satisfaction of Texmate to be thus defective. The warranty shall not apply to any equipment which shall have been repaired or altered, except by Texmate, or which shall have been subjected to misuse, negligence, or accident. In no case shall Texmate's liability exceed the original purchase price. The aforementioned provisions do not extend the original warranty period of any product which has been either repaired or replaced by Texmate.

USER'S RESPONSIBILITY

We are pleased to offer suggestions on the use of our various products either by way of printed matter or through direct contact with our sales/application engineering staff. However, since we have no control over the use of our products once they are shipped, **NO WARRANTY WHETHER OF MERCHANTABILITY, FITNESS FOR PURPOSE, OR OTHERWISE** is made beyond the repair, replacement, or refund of purchase price at the sole discretion of Texmate. Users shall determine the suitability of the product for the intended application before using, and the users assume all risk and liability whatsoever in connection therewith, regardless of any of our suggestions or statements as to application or construction. In no event shall Texmate's liability, in law or otherwise, be in excess of the purchase price of the product.

Texmate cannot assume responsibility for any circuitry described. No circuit patent or software licenses are implied. Texmate reserves the right to change circuitry, operating software, specifications, and prices without notice at any time.



1934 Kellogg Ave., Carlsbad, CA 92008
 Tel: 1-760-598-9899 • USA 1-800-839-6283 • 1-800-TEXMATE
 Fax: 1-760-598-9828 • Email: orders@texmate.com • Web: www.texmate.com

FL-BDPSF-PROCESS Technical Manual Copyright © 2019 Texmate Inc. All rights reserved. Published by: Texmate Inc. USA. Information in this Technical Manual is subject to change without notice due to correction or enhancement. The information described in this manual is proprietary to Texmate, Inc. and may not be copied, reproduced or transmitted, in whole or in part, in connection with the design, manufacture, or sale of apparatus, device or private label product without the express written consent of Texmate, Inc.