

FK4B01100L1

Single N-channel MOS FET

For load switching circuits

■ Features

- Low Drain-source ON resistance: $R_{DS(on)}$ typ. = 27 m Ω ($V_{GS} = 2.5$ V)
- CSP (Chip Size Package)
- RoHS compliant (EU RoHS / MSL: Level 1 compliant)

■ Marking Symbol: 1A

■ Packaging

Embossed type (Thermo-compression sealing) : 1 000 pcs / reel (standard)

■ Absolute Maximum Ratings $T_a = 25$ °C

Parameter	Symbol	Rating	Unit
Drain-Source Voltage	V _{DS}	12	V
Gate-Source Voltage	V _{GS}	±8	V
Drain Current	ID1 ^{*1}	3.4	A
	ID2 ^{*2}	5.2	
	ID3 ^{*3}	6.5	
Peak Drain Current	IDp1 ^{*1*4}	27	A
	IDp2 ^{*2*4}	41	
	IDp3 ^{*3*4}	52	
Power Dissipation	PD1 ^{*1}	0.36	W
	PD2 ^{*2}	0.82	
	PD3 ^{*3}	1.3	
Channel Temperature	T _{ch}	150	°C
Operating Ambient Temperature	T _{opr}	-40 ~ +85	°C
Storage Temperature	T _{stg}	-55 ~ +150	°C

Note *1 FR4 board (25.4mm×25.4mm×1.0mm), Min Cu 36mm² Copper

*2 FR4 board (25.4mm×25.4mm×1.0mm), Full Cu

*3 Ceramic substrate (70mm×70mm×1.0mm)

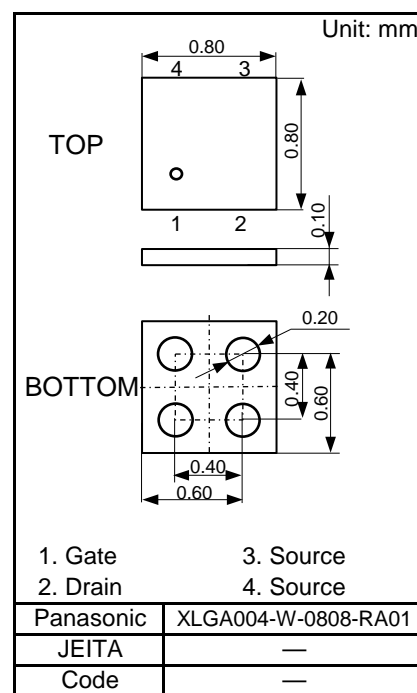
*4 t = 10 μ s, Duty Cycle < 1%

■ Internal Connection

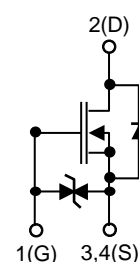

■ Electrical Characteristics Ta = 25 °C ± 3 °C

Parameter	Symbol	Conditions	Min	Typ	Max	Unit
Drain-Source Breakdown Voltage	VDSS	ID = 1 mA, VGS = 0	12			V
Zero Gate Voltage Drain Current	IDSS	VDS = 12 V, VGS = 0			10	μA
Gate-Source Leakage Current	IGSS	VGS = ±8 V, VDS = 0 V			±10	μA
Gate Threshold Voltage	Vth	ID = 236 μA, VDS = 10 V	0.3		1.0	V
Drain-Source ON Resistance	RDS(on)	ID = 1.5 A, VGS = 4.5 V		22	30	mΩ
		ID = 1.0 A, VGS = 2.5 V		27	40	
		ID = 0.5 A, VGS = 1.8 V		33	56	
		ID = 0.25 A, VGS = 1.5 V		43	99	
Input Capacitance ^{*1}	Ciss	VDS = 10 V		275		pF
Output Capacitance ^{*1}	Coss	VGS = 0		100		
Reverse Transfer Capacitance ^{*1}	Crss	f = 1MHz		70		
Turn-on delay time ^{*1,*2}	td(on)	VDD = 6 V VGS = 0 to 4.5 V ID = 1.0 A		7		ns
Rise time ^{*1,*2}	tr			14		
Turn-off delay time ^{*1,*2}	td(off)			165		
Fall time ^{*1,*2}	tf			76		
Total Gate Charge ^{*1}	Qg	VDD = 6 V		5.8		nC
Gate to Source Charge ^{*1}	Qgs	VGS = 4.5 V		0.75		nC
Gate to Drain Miller Charge ^{*1}	Qgd	IS = 1.0 A		0.95		nC
Body Diode Forward Voltage	VF(D-S)	IF = 0.2A, VGS = 0V		0.6	1.2	V

Note Measuring methods are based on JAPANESE INDUSTRIAL STANDARD JIS C 7030 Measuring methods for transistors.

*1 Guaranteed by design, not subject to production testing

*2 Measurement circuit for Turn-on delay time / Rise time / Turn-off delay time / Fall time

■ Electrical State Discharge Characteristics

Standard	Test Type	Symbol	Conditions	Class	Value	Unit
AEC-Q101-001	Human body model	HBM	C = 100 pF, R = 1.5 kΩ	H1C	>1k to ≤ 2k	V
	Machine model	MM	C = 200 pF, R = 0 Ω	M2	>100 to ≤ 200	V

Note2: Measurement circuit

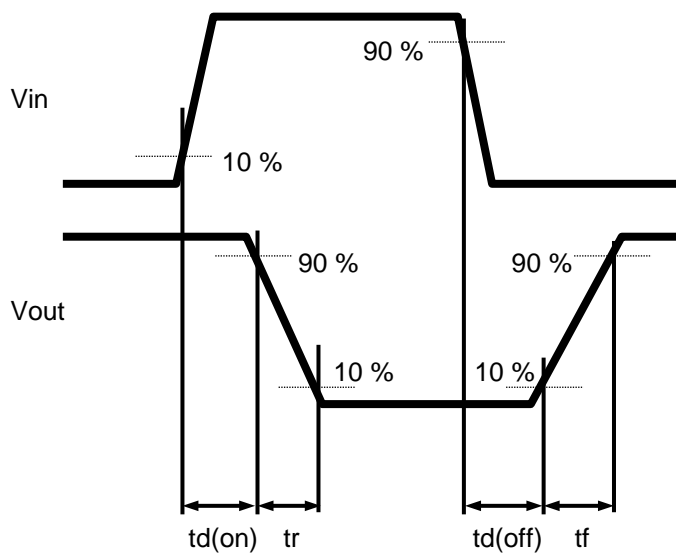
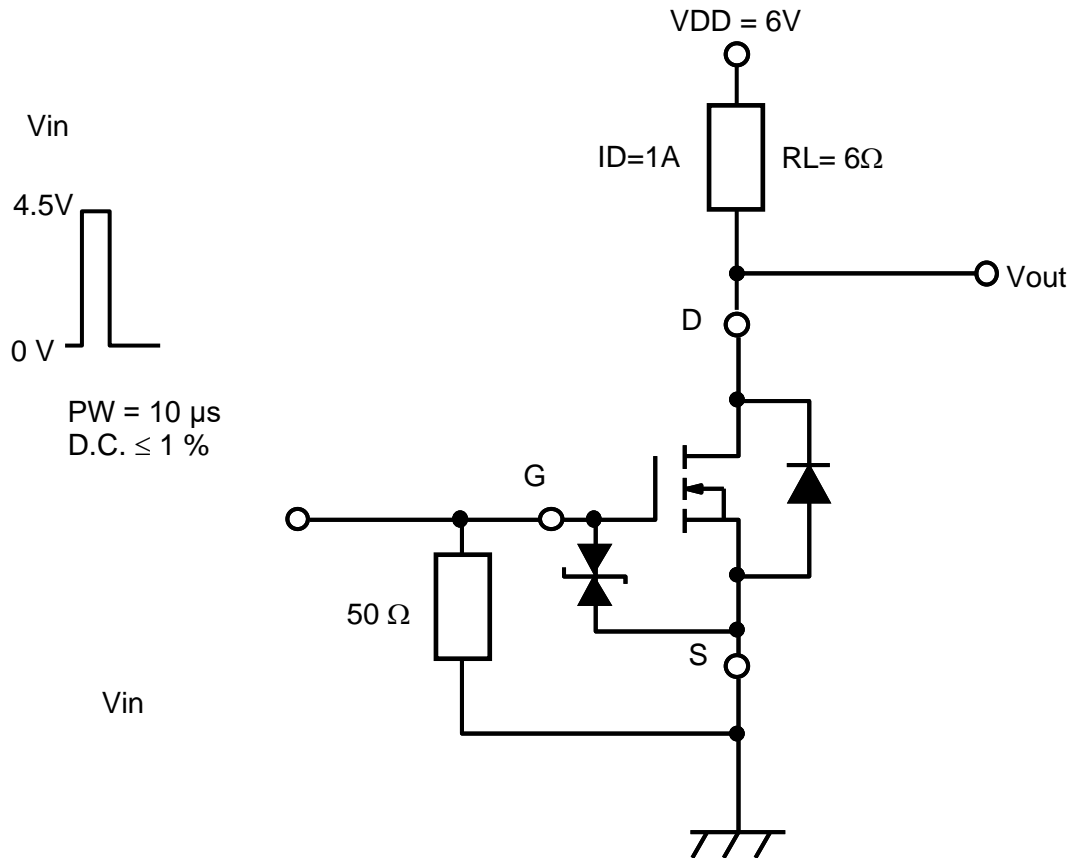



ID - VDS

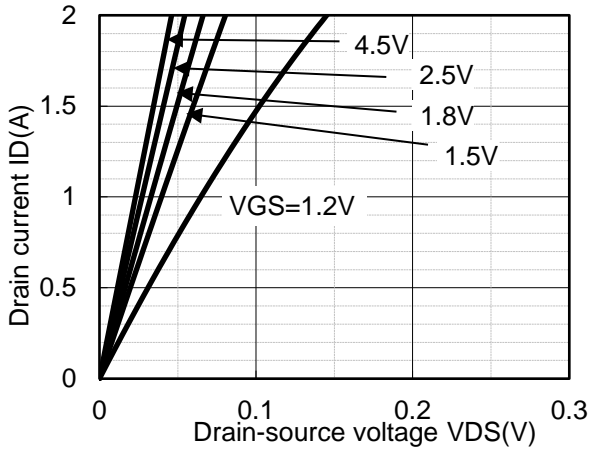

RDS(on) - ID

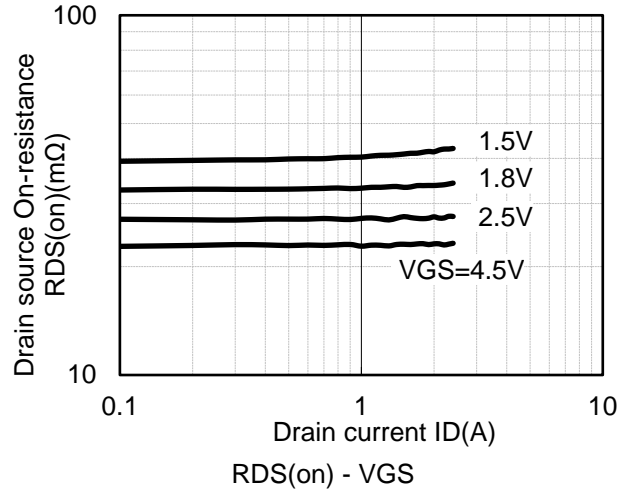

ID - VGS

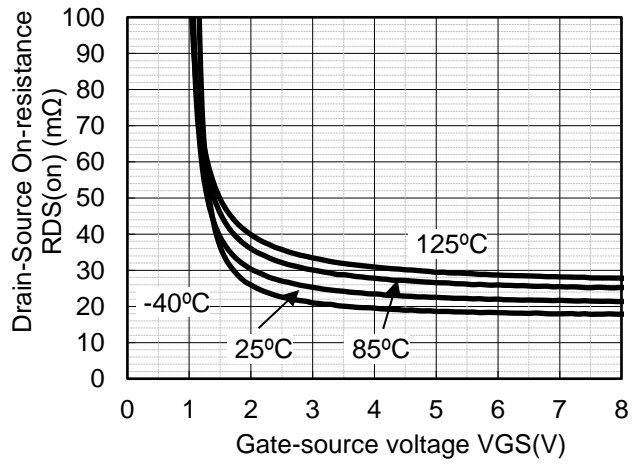
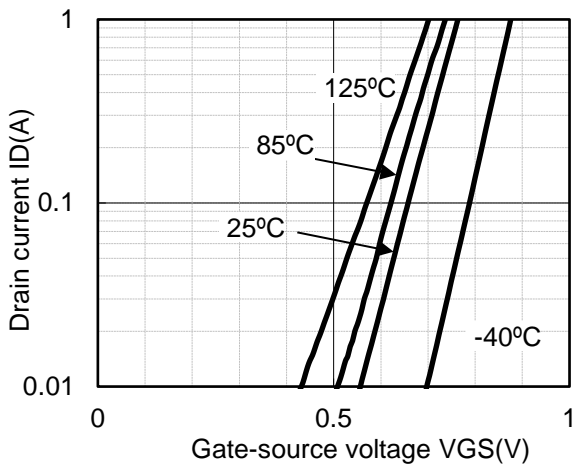

IF - VF

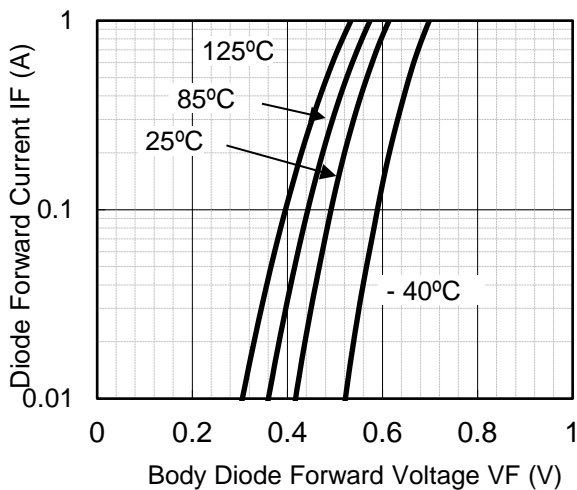

IGS - VGS

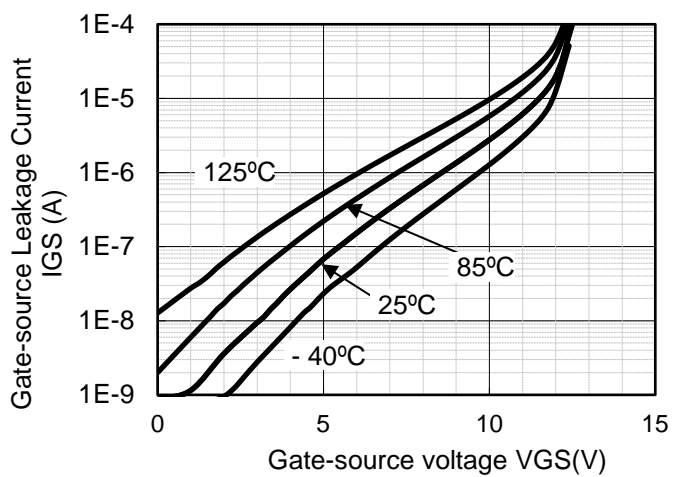



IDS - VDS

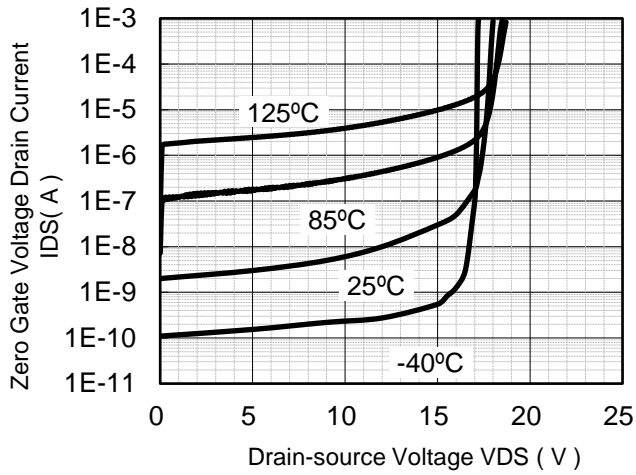

Dynamic Input/Output Characteristics

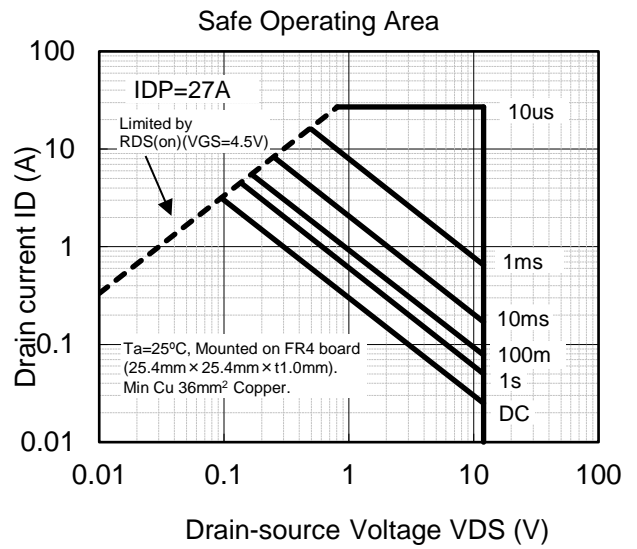
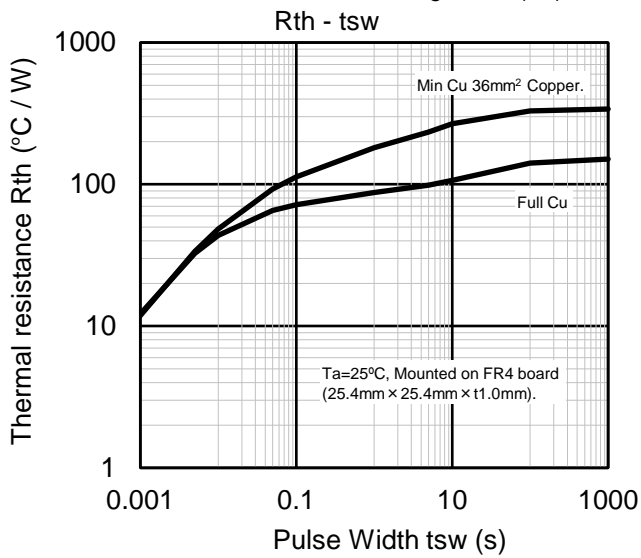
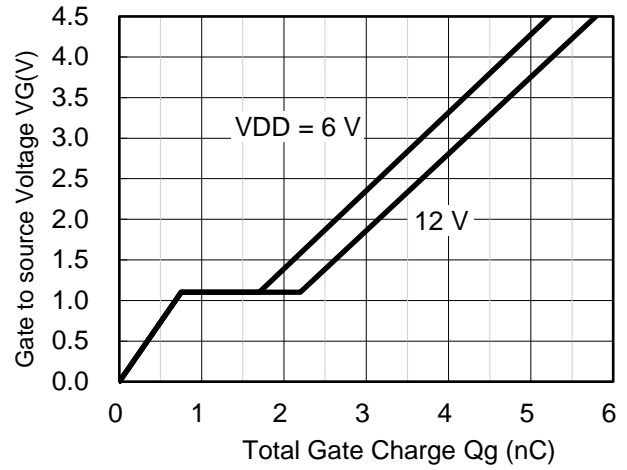

■ XLGA004-W-0808-RA01

Unit: mm

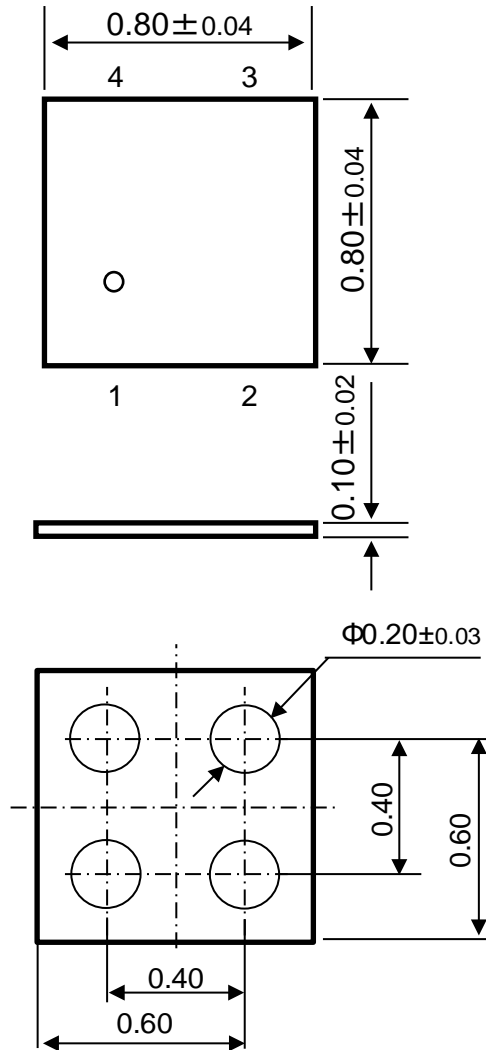

■ Land Pattern (Reference)

