



SPECIFICATIONS

Model	Stroke mm	Max Absorption Energy J(kgf·m)	Max Equivalent Mass kg (kgf)
FA-1010D2-C	10	0.98(0.1)	10(10)

Max Drag N (kgf)	Absorption Energy per min. J/min(kgf·m/min)	Extension Force N(kgf)	Mass g
980 (100)	44.1(4.5)	5.88(0.6) or lower	41.5

COMMON SPECIFICATIONS

Operating Speed Range	m/s	0.1~1.0
Maximum Cycle Rate	cycle/min	45
Operating Temperature	C°	-10~50

PRECAUTIONS FOR USE

- Do not use this product without carefully reading the attached owner's manual.
- Use with an external stopper.
- Ensure that sufficient mounting strength is secured for this product. (As a guideline, it should be 2 to 3 times the maximum drag listed in the catalogue.)
- Do not turn the oil inlet screw located at the bottom of the main unit.
- 2 or more of this product can be used in parallel.
- Do not use this product in a vacuum or a location where it may come in contact with oil.
- Ensure that an eccentric load is not applied to the soft absorber. (Allowable eccentric angle: within $\pm 2.5^\circ$)

OPTIONAL PARTS

Liquid-proof cap FA-1010D2-C-60

- A drip-proof cap is fitted on the main unit when shipped from the factory.
- Ideal for use in environments where oil splatter poses a problem.
- Ensure that the cap is facing upward. If the cap is facing sideways or downward, it cannot provide an effective means for liquid proofing.

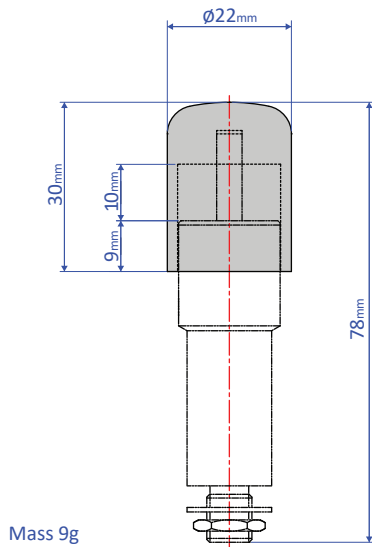

***Standard nuts are sold separately as well — M08 nut**

Bracket OP-1012A

- This is a mounting fixture for FA-1010D

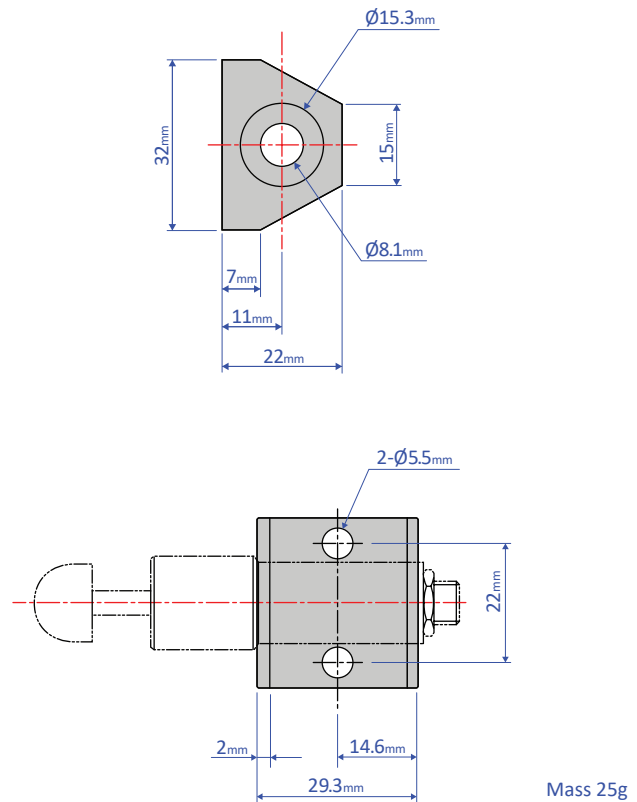

Bellofram seal type

Unlike the conventional U packing type, it uses a Bellofram seal, as shown in the diagram. Because it does not generate sliding resistance between the piston rod and the packing, the spring power required to recover the piston rod can be reduced. The Bellofram also acts as an accumulator based on its ability to change shape. In principle, as long as the Bello is not damaged, oil will never leak.

