



### SPECIFICATIONS

Model	Stroke mm	Max Absorption Energy J(kgf·m)	Max Equivalent Mass kg(kgf)
FA-0805SB1-S	5	0.39(0.04)	3(3)

Max Drag N(kgf)	Absorption Energy per min. J/min(kgf·m/min)	Extension Force N(kgf)	Mass g
490 (50)	17.6(1.8)	4.9(0.5) or lower	8.6

■ The thread pitch P1.0 is supplied as well

### COMMON SPECIFICATIONS

Range of Impact Rate	m/s	0.3~1
Maximum Cycle Rate	cycle/min	45
Operating Temperature	C°	-5~70

### PRECAUTIONS FOR USE

- Do not use this product without carefully reading the attached owner's manual.
- Ensure that an external stopper (Stopper nut OP-020SB) is also used.
- Do not turn the oil inlet screw located at the bottom of the main unit.
- Ensure that sufficient mounting strength is secured for this product. (As a guideline, it should be 2 to 3 times the maximum drag listed in the catalogue.)
- Do not use this product in a vacuum or a location where it may come in contact with oil.
- Ensure that an eccentric load is not applied to the soft absorber. (Allowable eccentric angle: within  $\pm 2.5^\circ$ )

## OPTIONAL PARTS

### Eccentric angle adaptor OP-010MB

- Screw the eccentric angle adaptor into the main unit until the cap for the eccentric angle and the piston rod form a tight connection. While maintaining this position, fasten the main unit's nut until it is secured.
- Use the eccentric angle adaptor when the eccentric angle is  $2.5^\circ$  or larger.
- The main unit can also be used as a stopper.
- Use it with a capless soft absorber.
- The maximum operating eccentric angle with an eccentric angle adaptor is  $\pm 10^\circ$ .
- The caps and the guides for inclined use are not unbundled.

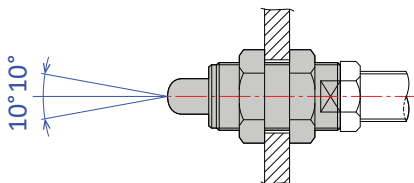
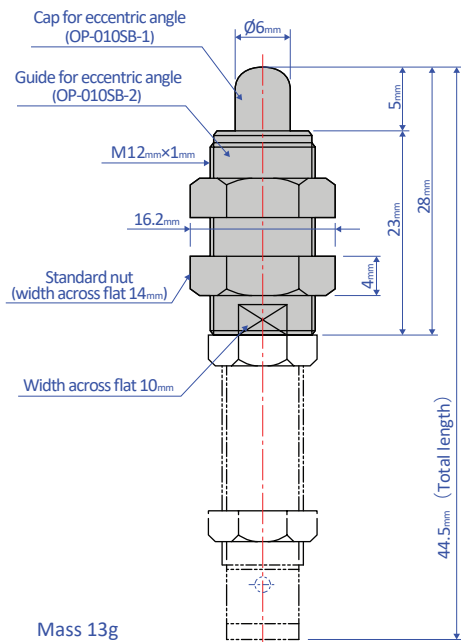

Note: Material of cap for eccentric angle: POM

### Stopper nut OP-020SB

- Adjust so that it stops 1 mm before the stroke end, and fasten with the main unit's nut until secured.

#### OP-020SB-S (without cap)

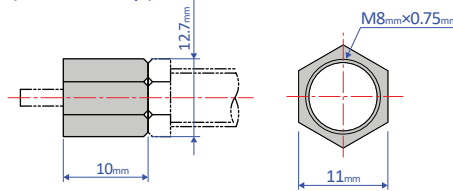

Mass 5g

#### OP-020SB-C (with cap)

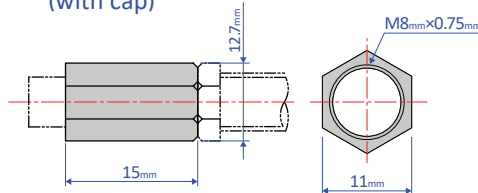

Mass 7g

Note: When attaching, make sure that the side without a bearing chamfer is the impact surface.

Standard nuts are sold separately as well - M08 Nut

### Holder with a switch OP-030SB-2

- Although a holder with a switch can be ordered on its own, we strongly recommend ordering one with the main unit. Please include the main unit's model number when placing an order.

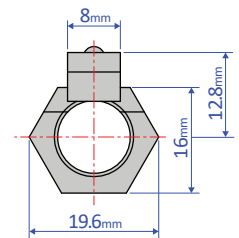
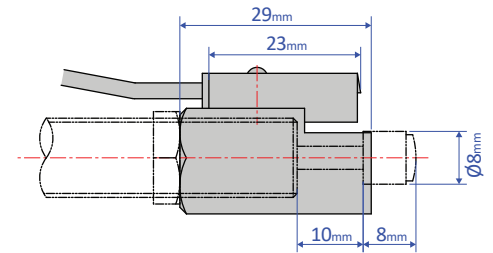

Mass 38g

### Square flange OP-040SB

- Once the attachment site is determined, use the main unit's nut to securely fasten in place.

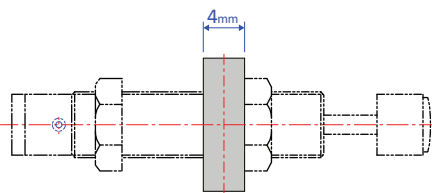
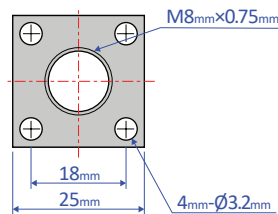

Mass 17g