

Document information

Title	EVK-ANNA-B4		
Subtitle	Evaluation kit for ANNA-B4 modules		
Document type	User guide		
Document number	UBX-21008123		
Revision and date	R04	2-May-2023	
Disclosure restriction	C1-Public		

This document applies to the following products:

Product name	Type number	Firmware version	PCN reference
EVK-ANNA-B402U	EVK-ANNA-B402U-00	N/A	-
EVK-ANNA-B402C	EVK-ANNA-B402C-00	N/A	-
EVK-ANNA-B412U	EVK-ANNA-B412U-00	All	-
EVK-ANNA-B412C	EVK-ANNA-B412C-00	All	-

u-blox or third parties may hold intellectual property rights in the products, names, logos and designs included in this document. Copying, reproduction, or modification of this document or any part thereof is only permitted with the express written permission of u-blox. Disclosure to third parties is permitted for clearly public documents only. The information contained herein is provided "as is". No warranty of any kind, either express or implied, is made in relation to the accuracy, reliability, fitness for a particular purpose or content of this document. This document may be revised by u-blox at any time. For most recent documents, please visit www.u-blox.com.
Copyright © u-blox AG.

Contents

Document information	2
Contents	3
1 Quick start guide	5
1.1 Installing s-center evaluation software	5
1.2 Installing J-Link drivers	5
1.3 Installing serial port drivers	5
2 Product description	6
2.1 Overview	6
2.2 Kit includes	7
2.3 Key features	7
2.4 EVK-ANNA-B4 block diagram	9
2.5 Connectors	10
3 Setting up the evaluation board	11
3.1 Software and hardware preparation	11
3.1.1 Installing software	11
3.1.2 Connecting external antennas	11
3.1.3 Power on evaluation board	11
3.1.4 Assigning COM ports	12
3.2 Starting up	12
3.2.1 EVK-ANNA-B412	12
3.2.2 EVK-ANNA-B402	12
3.3 Measuring current consumption	13
3.3.1 Using an amperemeter	13
3.3.2 Using a voltmeter	13
3.3.3 Using an external power supply or power analyzer	14
4 Board configuration	15
4.1 Powering options	15
4.1.1 Selecting the power configuration jumpers	15
4.1.2 Default power configuration, 3.3 V	17
4.1.3 Battery powered, 3.0 – 1.7 V	19
4.1.4 Battery powered with protection diode, 2.7 – 1.7 V	20
4.1.5 External supply, 3.6 – 1.7 V	21
4.1.6 Raspberry Pi HAT	22
4.2 Disconnecting ANNA signals from board peripherals	23
5 Interfaces and peripherals	25
5.1 Buttons and LEDs	25
5.2 Arduino interface	26
5.2.1 Arduino shield compatibility	28
5.3 Raspberry Pi compatible interface	28
5.3.1 Powering considerations	31

5.3.2	UART	31
5.3.3	EEPROM support	31
5.4	Additional Interfaces	31
5.4.1	Extra USB to UART interface	33
5.4.2	CPU trace interface	33
Appendix	34
A Schematics	34
B Assembly drawings	39
C Glossary	41
Related documents	42
Revision history	42
Contact	42

1 Quick start guide

EVK-ANNA-B4 software and documentation is available at www.u-blox.com/evk-search.

1.1 Installing s-center evaluation software

s-center is a powerful and easy-to-use tool for evaluating, configuring, and testing u-blox short range modules. Running on Windows 10 operating systems, the software allows end users to assess and configure u-blox short range modules using the EVK.

Follow the procedure outlined below to download and install the s-center software and documentation. The software can be downloaded from the u-blox [s-center](#) product page and is available free of charge.

1. Download the latest s-center software to your computer.
2. Open the s-center setup installer to install the software.
3. Select Launch button in the installer or open the application from the Windows Start button.

1.2 Installing J-Link drivers

Follow the procedure outlined below to install the J-Link drivers needed for programming the module.

1. Connect the EVK-ANNA-B4 board to your PC using the USB cable provided with the product.
2. Verify that the USB drivers are installed successfully. If the drivers do not install automatically, see also [Evaluation board setup](#).
3. Once the drivers are installed, a COM port is enabled in Windows. Use the Windows Device Manager to view the COM port number for the USB serial port.
4. Start s-center to communicate with the module.

For EVK-ANNA-B4x2U (with external antenna), attach the antenna to the antenna cable and connect the antenna cable to the U.FL connector.

1.3 Installing serial port drivers

EVK-ANNA-B4 EVKs include a mounted FTDI chip to provide serial port connectivity. Normally the driver for the UART is installed automatically when the board is connected. If the driver fails to install, the driver files can be retrieved from the manufacturers website [\[10\]](#).

2 Product description

2.1 Overview

The EVK-ANNA-B4 evaluation kit is a versatile development platform that allows quick prototyping of a variety of extremely low-powered Internet of Things (IoT) applications, using full Bluetooth 5.1, NFC, and IEEE 802.15.4.

EVK-ANNA-B4 boards are available in the following four variants that accommodate alternative antenna and software solutions:

- EVK-ANNA-B402U – includes an open CPU ANNA-B402 module and U.FL antenna connector for connecting to external antennas.
- EVK-ANNA-B402C – includes an open CPU ANNA-B402 module with an internal 2.4 GHz antenna (integrated in the SiP).
- EVK-ANNA-B412U – includes an ANNA-B412 module, pre-flashed with u-connectXpress software, and a U.FL antenna connector for connecting to external antennas.
- EVK-ANNA-B412C – includes an ANNA-B412 module, pre-flashed with u-connectXpress software, and an internal 2.4 GHz antenna (integrated in the SiP).

 The “Atmel” debug chip is not mounted on ANNA-B412 u-connectXpress secure-boot EVKs as it serves no useful purpose on secure modules.



(a) EVK-ANNA-B402U/B412U

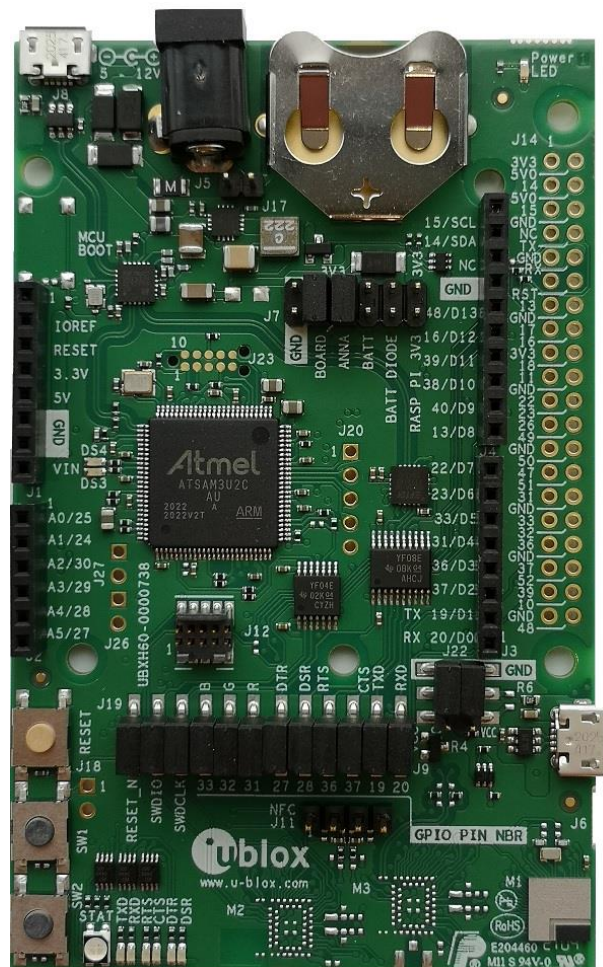

(b) EVK-ANNA-B402C/B412C

Figure 1: EVK-ANNA-B4 evaluation boards

All ANNA-B4 standalone modules include an Arm® Cortex®-M4F microcontroller with a 64 MHz system clock, 512 kB internal flash and 128 kB RAM.

EVK-ANNA-B4 evaluation boards provide access to the 33 GPIO pins and interfaces supported on ANNA-B4 modules. The interfaces are available through a variety of connectors, including Arduino™ Uno R3 [1] and Raspberry Pi [2] header connectors. The boards also support simple USB drag-and-drop programming and SEGGER J-Link debug interface that can be used with the open CPU variants of the EVK.

Nordic Semiconductors, the manufacturer of the nRF52833 SoC, provide a free Software Development Kit (SDK) that includes a broad selection of drivers, libraries, and example applications that can be used for rapid prototyping.

2.2 Kit includes

The EVK-ANNA-B4 evaluation kit includes the following:

- ANNA-B4 evaluation board
- Two 2.4 GHz antennas with U.FL connector (only for EVK-ANNA-B402U and EVK-ANNA-B412U)
- NFC antenna
- USB cable

2.3 Key features

- ANNA-B402 Open CPU, based on Nordic nRF52833 SoC, Bluetooth 5.1 Low Energy modules:
 - Ultra-compact SiP (6.5 x 6.5) offering both internal and external antenna options
 - Open CPU for embedded application development
 - Integrated Arm® Cortex®-M4F microcontroller with 512kB internal flash and 128 kB RAM, and 64 MHz system clock
 - Full Bluetooth 5.1 functionality including long range and direction finding (AoA/ AoD)
 - NFC tag, Bluetooth mesh, Zigbee and Thread
 - HW interfaces:
 - 33 GPIO pins
 - 2x UART
 - 4x SPI
 - 16x PWM capable outputs
 - 8x analog capable inputs
 - 2x I2C
 - 1x I2S
 - 1x PDM input
 - 1x Quadrature decoder
 - 1x USB 2.0
 - Wide 1.7-3.6 V supply range
 - Extended temperature range up to +105 °C
 - Global certification

- ANNA-B412 with u-connectXpress software, based on Nordic nRF52833 SoC, Bluetooth 5.1 Low Energy modules:
 - Ultra-compact SiP (6.5 x 6.5) offering both internal and external antenna options
 - Pre-flashed u-connectXpress software for accelerated time to market
 - Integrated Arm® Cortex®-M4F microcontroller with 64 MHz system clock
 - Pre-flashed u-connectXpress software supporting u-blox Bluetooth Low Energy Serial Port Service, GATT client and server, beacons, Bluetooth long range, NFC™, and simultaneous peripheral and central roles.
 - Direction Finding (AoA/ AoD) capability, u-connectLocate is available on request
 - HW interfaces:
 - 19 GPIO pins
 - 2x UART
 - Bluetooth mesh, available on request
 - Superior security functionality with secure boot
 - Wide 1.7-3.6 V supply range
 - Extended temperature range up to +105 °C
 - Global certification

- EVK-ANNA-B4xx evaluation boards:
 - Two EVK variants:
 - EVK-ANNA-B402 with ANNA-B402 Open CPU modules
 - EVK-ANNA-B412 with ANNA-B412 modules with u-connectXpress software
 - Full UART to USB converter with a virtual COM port for control of the extended UART features of the u-connectXpress software (EVK-ANNA-B412 only)
 - On-board J-Link debugger/programmer with:
 - Mass Storage Device interface to PC, for drag-and-drop programming
 - Debug port
 - Additional virtual COM port that connects to add-on boards, or debug UART on ANNA-B4
 - Dedicated USB connector for the ANNA-B402/B412 USB interface
 - RGB LED and push buttons
 - Arduino UNO R3 and Raspberry Pi compatible pin header interfaces
 - Pin header connectors and level shifters allow for flexible power supply options with different jumper connections for the ANNA- B402/B412 module. The jumpers can isolate the module entirely from other functional parts of the evaluation board to save battery life and control each power net separately to measure low-power applications precisely.
 - Multiple board power supply options include:
 - 5 V USB supply
 - 5-12 V external power supply
 - 5-12 V Arduino VIN input
 - 3 V CR2032 coin cell battery

2.4 EVK-ANNA-B4 block diagram

Figure 2 shows the major interfaces and internal connections supported on the EVK-ANNA-B4.

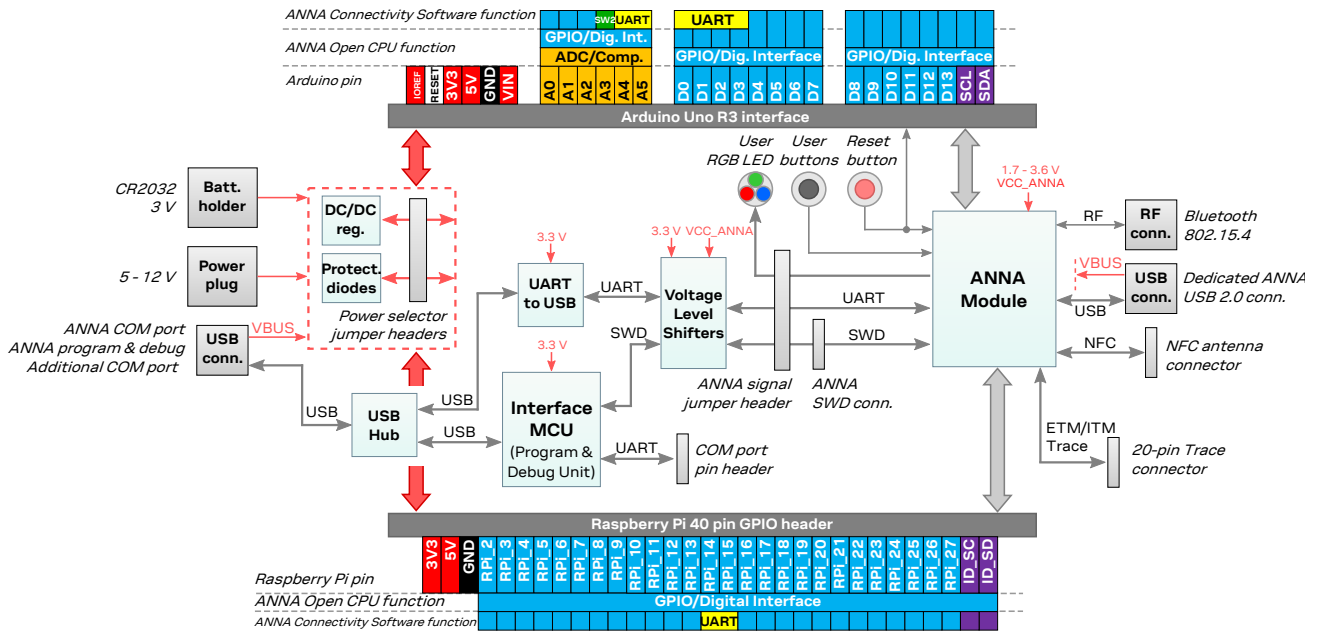

Figure 2: EVK-ANNA-B4 block diagram

2.5 Connectors

Table 1 describes the available connectors of the EVK-ANNA-B4 shown in [Figure 3](#).

Connector	Function	Description
J5	Power supply	2.1 mm power jack. The center pin of the connector is the positive terminal. 5 – 12 V input.
J17	Power supply	Pin header for connecting external power supplies. 5 – 12 V input.
BT1	Battery holder	CR2032 coin cell battery holder. CR2032 usually has a 3 V potential when fully charged.
J11	NFC antenna connector	Pin header that connects to the u-blox NFC antenna included in the kit. The antenna can be mounted in either direction.
J10	2.4 GHz RF antenna connector	U.FL coaxial connector used to connect antennas or RF equipment. This connector is only included in the EVK-ANNA-B402U/EVK-ANNA-B412U.
J12	Cortex Debug connector	10-pin, 50 mil pitch connector used to connect external debuggers to the ANNA-B4 module. ANNA-B4 modules support Serial Wire debug (SWD) and Serial Wire Viewer, but not JTAG debug.
J8	Power supply, COM port and debug USB	The main USB connector used to program, debug, and communicate with the ANNA module. It can also be used to power the entire board.
J6	Power supply and ANNA USB port	Additional USB connector that connects directly to the ANNA-B4 USB interface. The connector can also be used to power the entire board.

Table 1: EVK-ANNA-B4 connector description

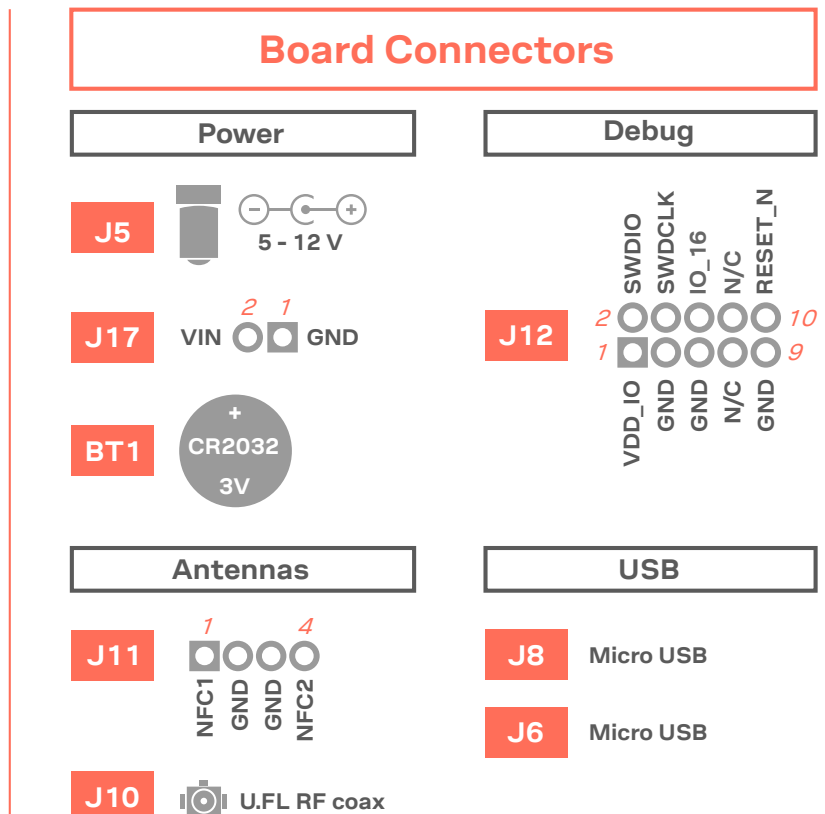
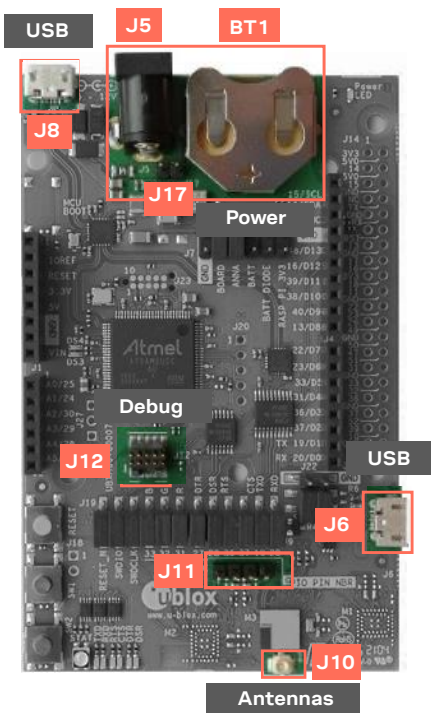

Figure 3: Available connectors, pinout and designation

3 Setting up the evaluation board

As introduced in [Overview](#) section, EVK-ANNA-B4 boards are available for four variants that accommodate alternative antenna and software solutions.

Setting up EVK-ANNA-B402 evaluation boards for the open CPU ANNA-B402 modules and EVK-ANNA-B412 evaluation boards for ANNA-B412 modules with pre-flashed u-connectXpress require different software and hardware prerequisites.

3.1 Software and hardware preparation

Before setting up EVK-ANNA-B402 and EVK-ANNA-B412 evaluation boards, some software and hardware prerequisites are needed.

3.1.1 Installing software

- **EVK-ANNA-B402 evaluation boards only**

J-Link drivers are needed for programming the open CPU ANNA-B402 modules. J-Link drivers are usually automatically installed on a PC correctly when the evaluation boards are plugged in. If the drivers are not installed automatically, download the J-Link driver included in the Nordic [nRF Command Line Tools](#) and follow the procedure [Installing J-Link drivers](#) to install the J-Link drivers needed for programming the open CPU ANNA-B402 modules. The drivers need only be installed once when you connect the EVK to a new computer.

- **EVK-ANNA-B412 evaluation boards only**

EVK-ANNA-B412 evaluation boards are pre-flashed with u-connectXpress software which enables users to configure EVK-ANNA-B4 modules using AT commands with u-blox s-center evaluation software. Follow the procedure [Installing s-center evaluation software](#) to install the u-blox s-center evaluation software.

3.1.2 Connecting external antennas

3.1.2.1 2.4 GHz antenna

To evaluate the 2.4 GHz radio on the EVK-ANNA-B402U and EVK-ANNA-B412U evaluation boards, external antennas might be needed. Connect a 2.4 GHz antenna to the U.FL connector (J10) on the ANNA-B402U or ANNA-B412U module if needed.

EVK-ANNA-B402C and EVK-ANNA-B412C board variants include internal antennas in the modules. External antennas are therefore not needed for evaluating these board variants

3.1.2.2 NFC antenna

To use any of the EVK-ANNA-B4 board variants as an NFC tag, an NFC antenna can be connected to the NFC antenna connector (J11).

3.1.3 Power on evaluation board

Before powering on the evaluation boards, make sure that the power configuration jumpers are connected according to your use cases, as described in [Powering options](#). The default configuration described in [Selecting the power configuration jumpers](#) works for most use cases.

Check the polarity of the EVK connector before connecting an external power supply to the EVK-ANNA-B4 evaluation board. Center conductor is positive (+) and the ring is negative (-).

Plug the external power supply to the power jack connector (J5), or connect a USB host to the USB connector (J8) with a USB cable. Alternatively, you can power on a EVK-ANNA-B4 evaluation board with a CR2032 coin cell battery. See also [Powering options](#) for more details.

3.1.4 Assigning COM ports

Two COM ports are automatically assigned to the device by Windows:

- The COM port labelled “USB Serial Port” is used to communicate with the UART interface of the ANNA-B4 module.
- The COM port labelled “JLink CDC UART Port” can be used as an extra USB to the UART interface. See also [Extra USB to UART interface](#).

Windows 7

To view assigned COM ports on Windows 7:

1. Open the **Control Panel** and select **Hardware and Sound**.
2. Open the **Device Manager** in **Devices and Printers**. This opens the Device Manager window where you can view the assigned COM ports.

Windows 10

To view assigned COM ports on Windows 10:

1. Right click the Windows **Start** button
2. Select **Device Manager**.

3.2 Starting up

3.2.1 EVK-ANNA-B412

3.2.1.1 u-connectXpress software

EVK-ANNA-B412 is equipped with ANNA-B412 module that runs the u-connectXpress software. The software is preinstalled on the module.



Go to the u-blox support webpage to obtain the latest available software. Instructions on reflashing the EVK-ANNA-B4 can be found in the Software section of the ANNA-B4 system integration manual [\[5\]](#).

3.2.1.2 s-center evaluation software

To communicate with the ANNA-B412 modules using AT commands, set the baud rate to 115200 with 8N1 flow control. See also [Quick start guide](#) .

All available AT commands are described in the u-connect AT commands manual [\[6\]](#).

To get started with the basic use-case setup of EVK-ANNA-B412 with u-connectXpress software, see the user guide [\[8\]](#).

3.2.2 EVK-ANNA-B402

3.2.2.1 Nordic Semiconductor SDK

To use the EVK-ANNA-B402 together with Nordic Semiconductor SDK it is necessary to:

- Create your own board file
- Adapt the examples in the Nordic Semiconductor SDK to use this board file

For more information about performing these tasks, see also the Software section of the ANNA-B4 system integration manual [\[5\]](#). See also the u-blox short range open CPU GitHub repository [\[9\]](#).

3.2.2.2 Software debug options

Use either of the following options to debug software with EVK-ANNA-B402:

- Onboard debug solution available through the USB connector
- External debugger connected to J12 connector

An external debugger is useful when powering the evaluation board with a CR2032 coin cell battery or an external power supply through the power jack connector J5. An external debugger is also useful when the MCU interface has been disconnected from the ANNA-B402 module using the jumpers on the J19 header.

SEGGER J-Link software [7] is necessary to debug with the onboard J-Link hardware on the EVK-ANNA-B402.

3.3 Measuring current consumption

 Before starting the current consumption measurement, check the [Board configuration](#) to identify your chosen power configuration and find out what ANNA signals must subsequently be isolated. The J22 jumper pins 1 and 3 must be removed to measure the current consumption.

[Figure 4](#) shows some suggestions for connecting the various instruments when measuring module current consumption.

3.3.1 Using an amperemeter

An amperemeter should be connected in series regardless of the power source and what is being measured. In this way, the current can be measured when the ANNA module is supplied from either the onboard 3.3 V regulator or an external supply.

3.3.2 Using a voltmeter

The EVK board must be modified before module current can be measured with a voltmeter.

To modify the board, solder a low resistance, high-tolerance, 0402 sized resistor to the footprint labeled R6. This resistor replaces the jumper normally positioned between J22 pins - 1 and 3 so that any current running through it produces a voltage across its terminals. Measure this voltage with the voltmeter and calculate the current using Ohm's law.

3.3.3 Using an external power supply or power analyzer

To measure the power consumption of the ANNA modules, connect the instrument terminals to the J22 pins, as shown in [Figure 4](#).

Since the external voltage of any connected instrument can never perfectly match the 3.3 V generated by the EVK, some small current leakage is apparent whenever the signal from the ANNA module is connected to an EVK peripheral. The leakage is typically in the order of one to several hundred nano amps.

To reduce leakage current, use a second external power channel to supply the EVK peripherals. This second channel must also be used to enable PC communication when using any ANNA supply voltages other than 3.3 V.

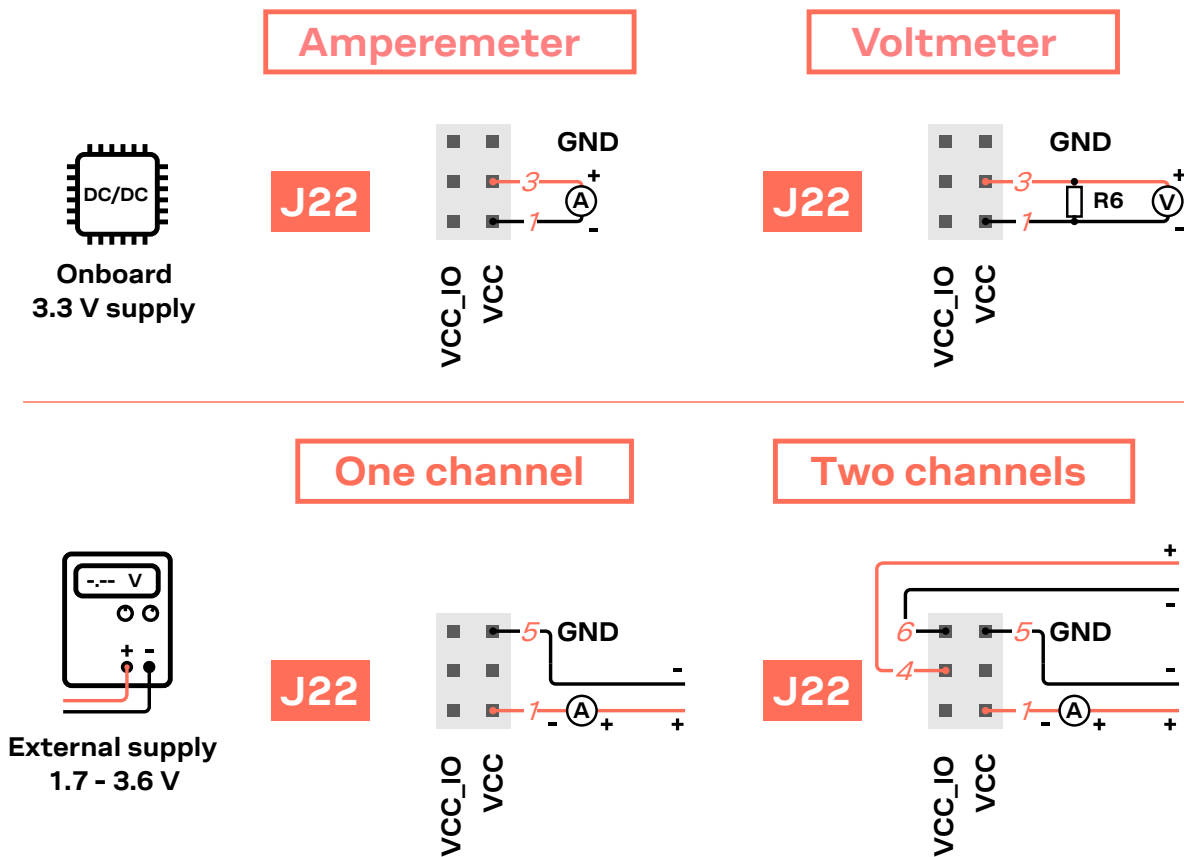

Figure 4: Different options when measuring current consumption of ANNA modules

4 Board configuration

4.1 Powering options

Power can be supplied to the board in any of the following ways:

- Through any of the USB connectors, J8 or J6
- Using the power jack, J5
- Through the Arduino interface, VIN pin.
- Using the Raspberry Pi interface 5V pins, J14.2 or J14.4
- Using the pin header, J17
- Plugging in a battery to the battery holder, BT1+

The power supply sources are distributed to the rest of the board as shown in [Figure 5](#).

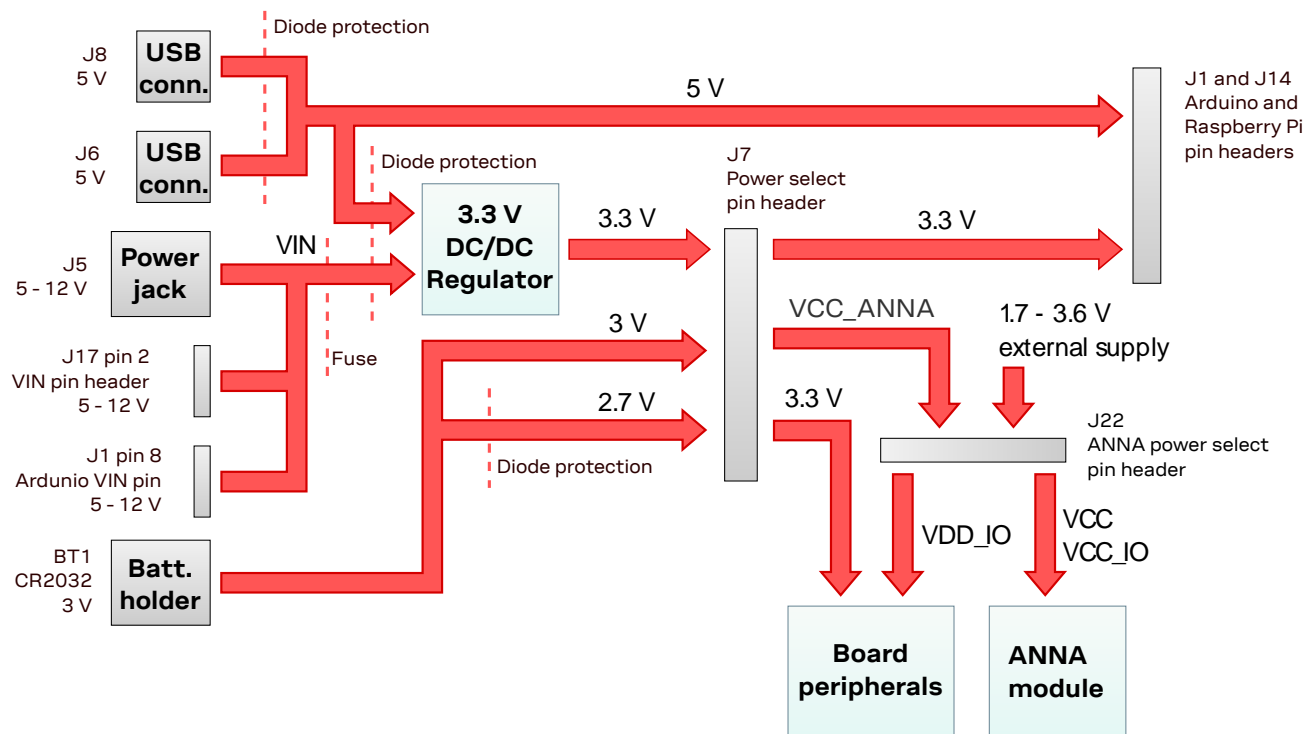

Figure 5: Block diagram of the power net distribution

4.1.1 Selecting the power configuration jumpers

EVK-ANNA-B4 offers flexible powering options for the ANNA-B4 module and the board itself. To configure the power options, jumpers are added to or removed from pin headers to connect or disconnect different power nets on the evaluation board. [Figure 6](#) provides an overview of the available power sources and targets. [Figure 7](#) shows the location of the power configuration pin headers.

- ⚠ Check the jumper positions carefully. Jumpers connected with incorrect polarity, can permanently damage the components that are either ON or connected to the board. Note also that some jumpers should not be mounted simultaneously. For instance, pins 5 and 6 and pins 7 and 8 on J7 connector should not be connected at the same time the battery is connected.

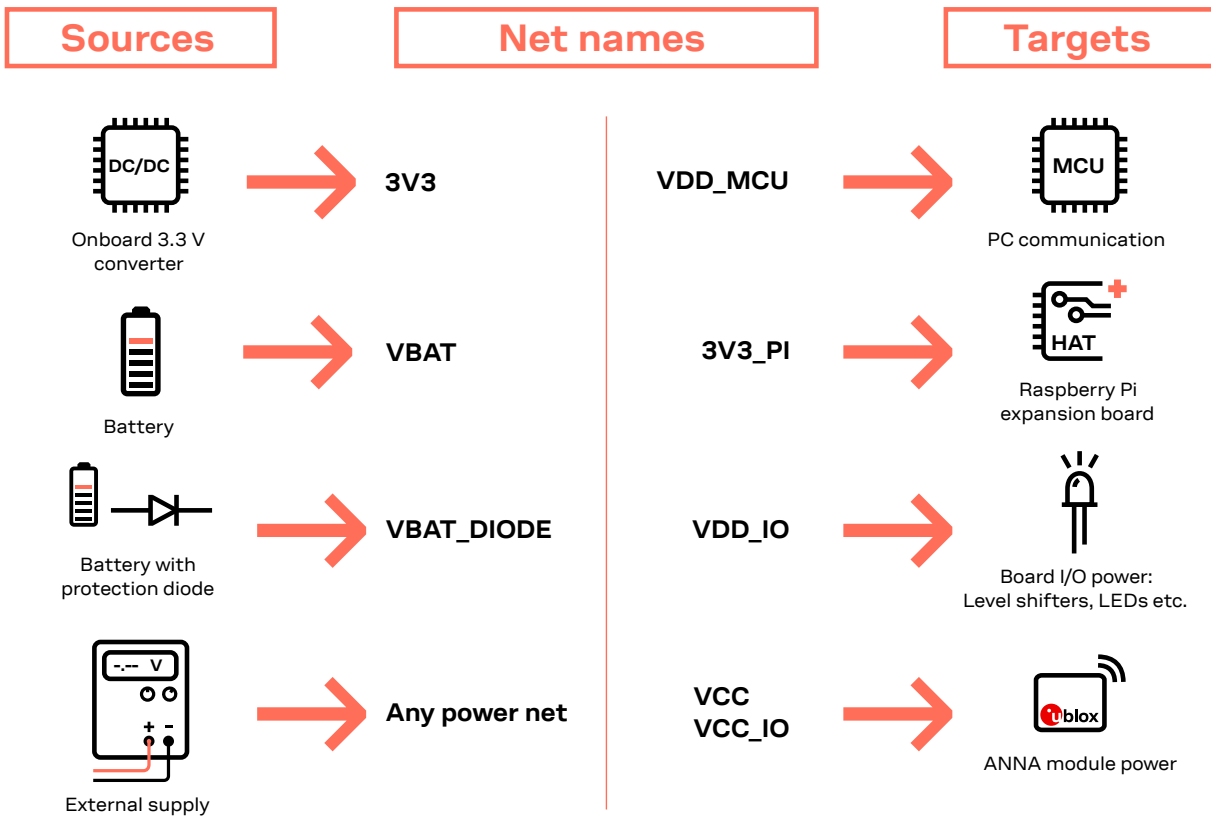

Figure 6: Overview of EVK power sources and targets showing connected schematic net names

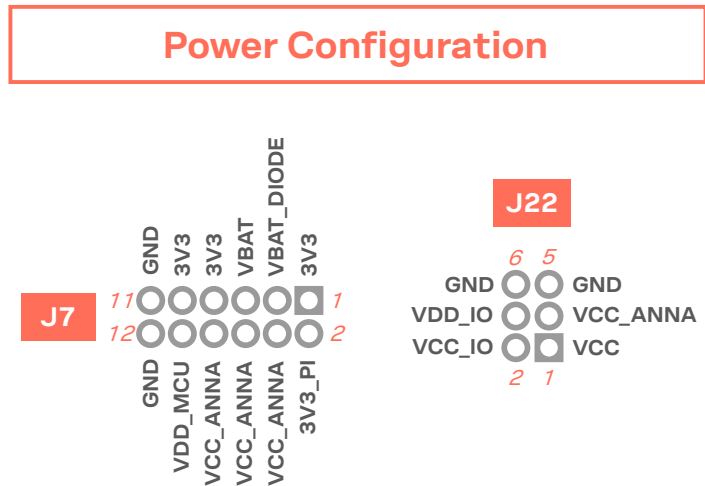
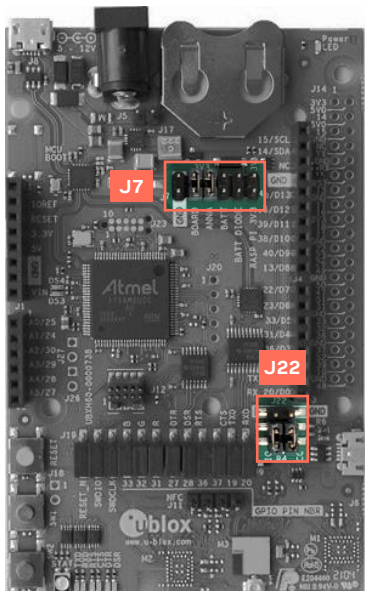

Figure 7: Pin header connectors J7 and J22 board location and pinout

Connector	Pin no.	Schematic net	Description
J7	1	3V3	Regulated 3.3 V net. This net is supplied by the board and is always powered when a power source is connected.
	2	3V3_PI	Connects to 3V3 pins of Raspberry Pi header connector J14. With a Raspberry Pi device attached, this net must be left unconnected to prevent back currents. If an add-on board HAT (Hardware Attached on Top) is connected, this net can be connected to the EVK 3.3 V supply to power the HAT.
	3	VBAT_DIODE	To protect the battery from current back surges, connect the battery to the ANNA module through a protection diode using this pin.
	4	VCC_ANNA	Connects to J22 pin 3 from which it can be connected to the module supply pin or somewhere else
	5	VBAT	Connects to positive side of the battery terminal (BT 1+)
	6	VCC_ANNA	Connects to J22 pin 3 from which it can be connected to the module supply pin or somewhere else
	7	3V3	Regulated 3.3 V net. This net is supplied by the board and is always powered when a power source is connected.
	8	VCC_ANNA	Connects to J22 pin 3 from which it can be connected to the module supply pin or somewhere else
	9	3V3	Regulated 3.3 V net. This net is supplied by the board and is always powered when a power source is connected.
	10	VDD_MCU	Supply net for board functions not directly connected to the ANNA module, including interfaces to the MCU, USB hub, UART to USB converter, etc.
	11	GND	Ground net
12	GND	Ground net	
J22	1	VCC	ANNA module voltage supply that connects to the module VCC pin. Connects to the VCC_IO net through a 0 Ω resistor R4 by default.
	2	VCC_IO	Connects to the ANNA module VCC_IO pin and the VCC net through a 0 Ω resistor R4 by default
	3	VCC_ANNA	Connects to J7 pins 4, 6 and 8
	4	VDD_IO	Supply net for level shifters, LEDs and peripherals connected directly to the ANNA module.
	5	GND	Ground net
	6	GND	Ground net

Table 2: Pinout of connectors J7 and J22 used to configure the board power nets

4.1.2 Default power configuration, 3.3 V

The out-of-box jumper positions for the EVK-ANNA power configuration are shown in [Figure 8](#). In this default configuration, the ANNA module is directly supplied by the EVK board with all board peripherals powered up and everything running at 3.3 V.

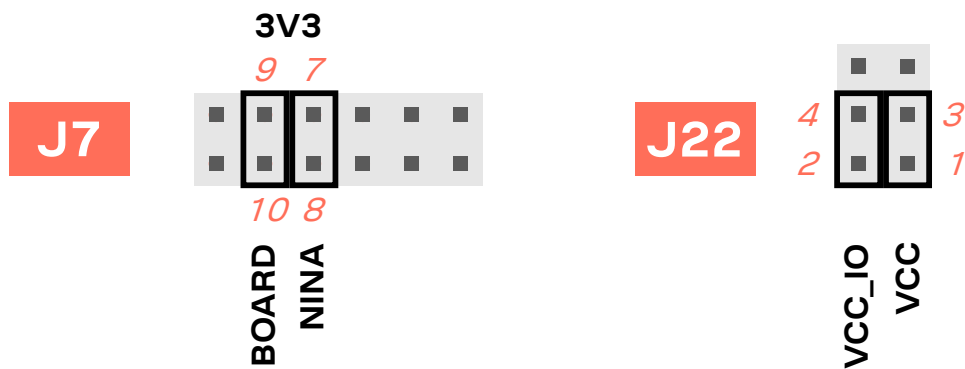
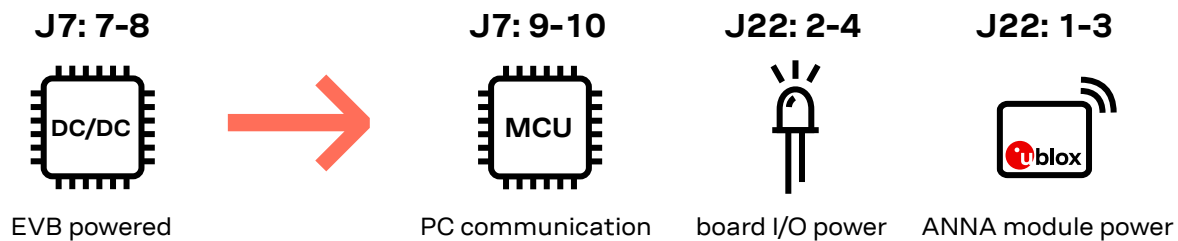
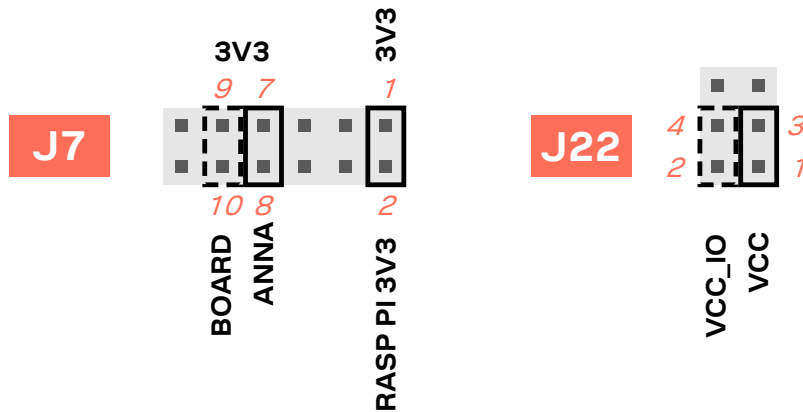
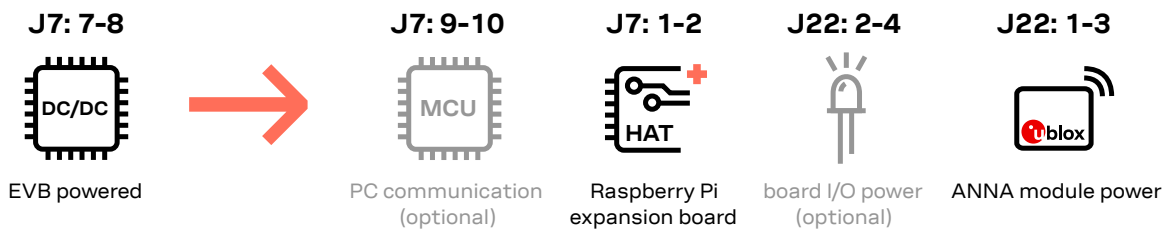



Figure 8: Jumper positions for default power configuration

Connector	Add jumper to pins	Description
J7	7, 8	Selects the board regulated 3.3 V net as source for the VCC_ANNA net
	9, 10	Powers up interfaces to the MCU, USB hub, and UART to USB converter with 3.3 V
J22	1, 3	Powers up the ANNA module. The ANNA VCC and VCC_IO pins are connected to the selected source for the VCC_ANNA net.
	2, 4	Powers up peripherals directly connected to ANNA, such as LEDs and external memory, from the module voltage supply.

Table 3: Jumper positions for default power configuration

4.1.3 Battery powered, 3.0 – 1.7 V

The configuration for using EVK-ANNA-B4 with a battery is shown [Figure 9](#). In this configuration the battery voltage is connected to **VCC_ANNA**, which in turn is connected to the ANNA-B4 VCC supply. If necessary, add jumper to pins 2 and 4 of J22 to supply LEDs and other peripherals with power – but only if this does not exceed the maximum current rating of the battery. If the ANNA module must be configured, add jumper to pins 9 and 10 of J7 to connect the **VDD_MCU** net and enable communications between a PC and the ANNA module.

-  Pins 9 and 10 of J7 and pins 2 and 4 of J22 must be connected to communicate with the ANNA module from a PC. As connecting an extra board peripheral might deplete the battery, the EVB power configuration should be switched to the default 3.3 V configuration.
-  To avoid damage to the battery, do not connect pins 5 and 6 and pins 7 and 8 on J7 at the same time the battery is connected.

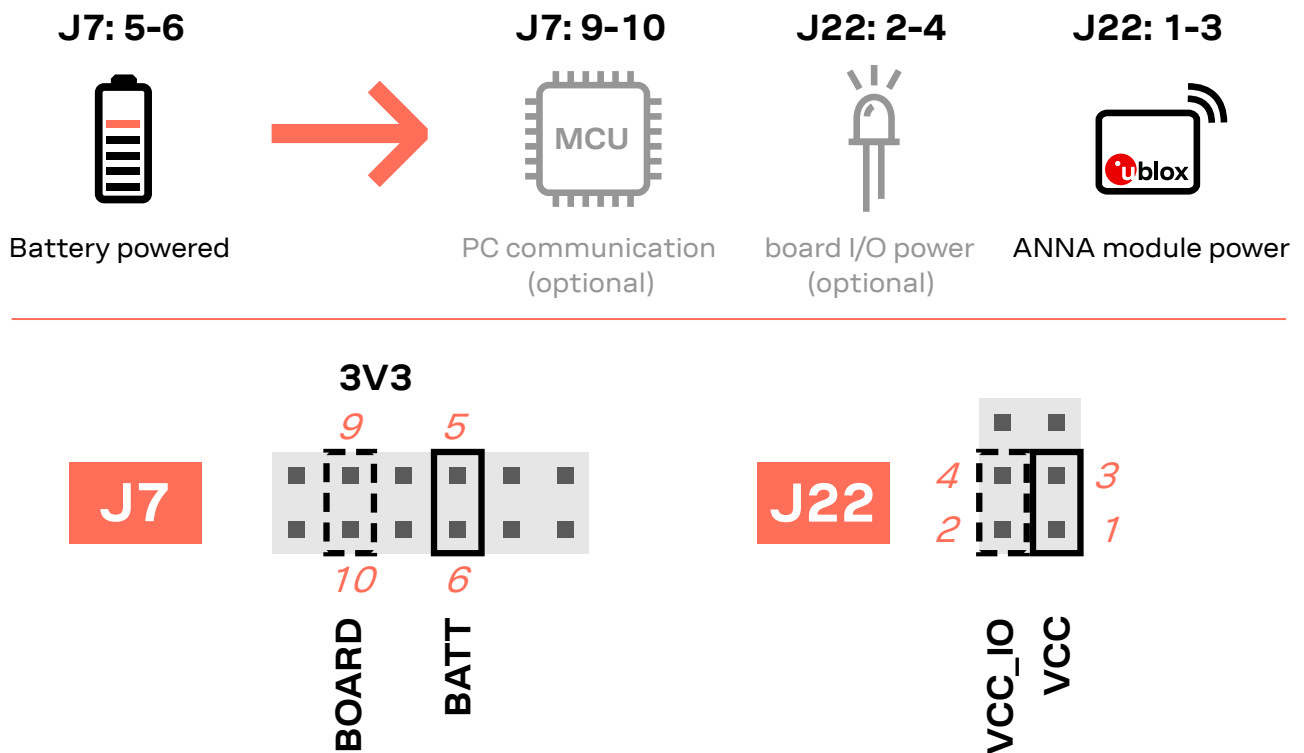

Figure 9: Jumper positions for battery powered operation, the jumpers shown in dashed lines are optional

Connector	Add jumper to pins	Description
J7	5, 6	Selects the battery connected to the battery holder as the source for the VCC_ANNA net
	9, 10	(Optional) Powers up interfaces to the MCU, USB hub, and UART to USB converter with 3.3 V
J22	1, 3	Powers up the ANNA module. The ANNA VCC and VCC_IO pins are connected to the chosen source for the VCC_ANNA net.
	2, 4	(Optional) Powers up peripherals directly connected to the ANNA module, such as LEDs and external memory, using the voltage supply to the module.

Table 4: Jumper positions for battery powered operation, two jumpers are optional

4.1.4 Battery powered with protection diode, 2.7 – 1.7 V

This power configuration protects the battery from current back surges. When using the NFC interface, there is a risk that the applied electromagnetic field can cause back surges on the module power lines. These back surges can damage a non-chargeable battery.

To block current back surges, connect pins 3 and 4 (instead pins 5 and 6) of J7 to add a schottky diode in series with the battery, as shown in [Figure 10](#).

 The diode lowers the battery voltage level by ~0.3 V.

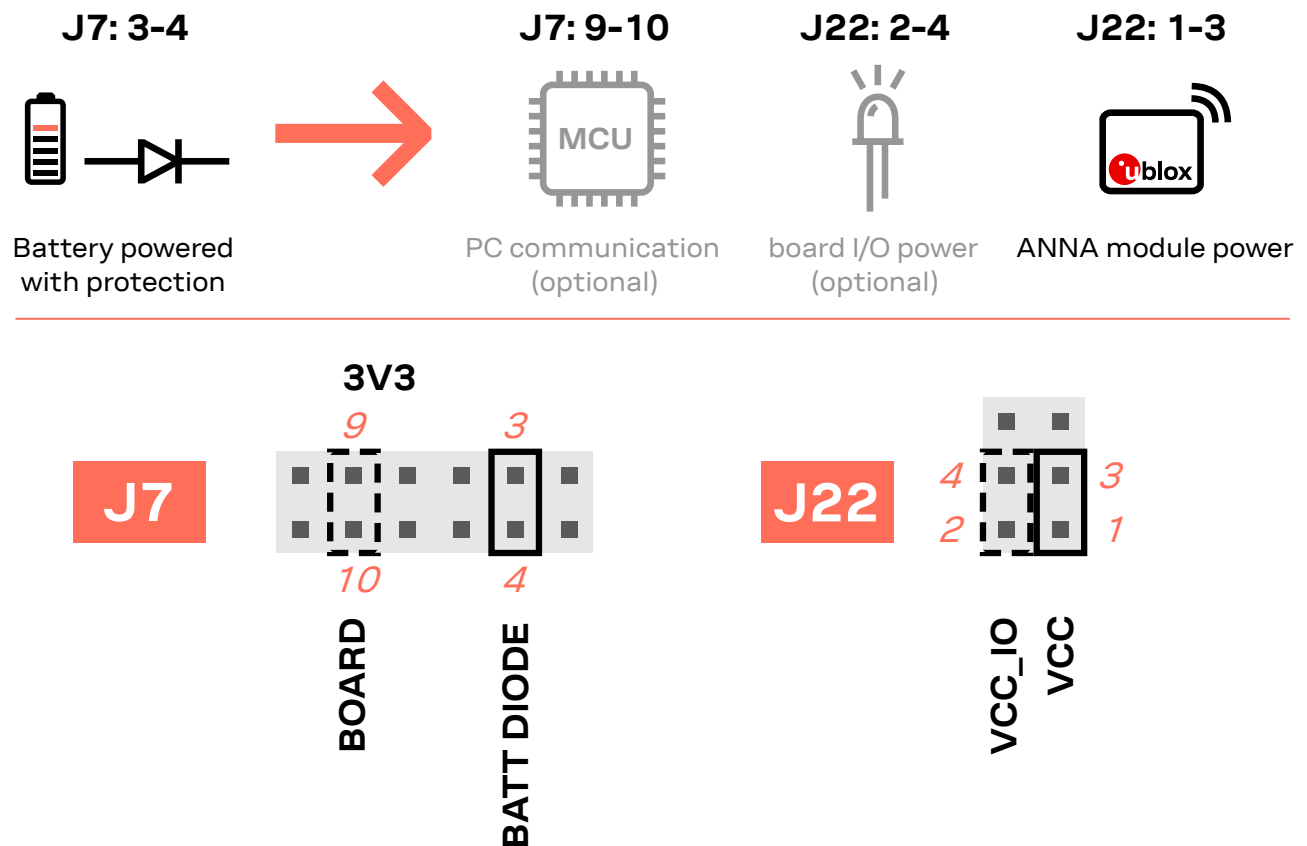

Figure 10: Jumper positions for battery-powered operation with a protection diode (dashed lines show optional jumpers)

Connector	Add jumper to pins	Description
J7	3, 4	Selects the diode-protected battery as a source for the VCC_ANNA net
	9, 10	(Optional) Powers up the Interface MCU, USB hub, and UART to USB converter with 3.3 V.
J22	1, 3	Powers up the ANNA module. The ANNA VCC and VCC_IO pins are connected to the selected source for the VCC_ANNA net.
	2, 4	(Optional) Powers up the peripherals directly connected to ANNA such as LEDs and external memory with the ANNA supply voltage.

Table 5: Jumper positions for battery powered operation with a protection diode (with two optional jumpers)

4.1.5 External supply, 3.6 – 1.7 V

When measuring current consumption or performing other ANNA-B4 module characterization measurements, it can be useful to power the module with an external source such as a lab power supply. In these instances, all jumpers must be removed so that the required supply nets can be fed externally through the pin headers J22. More specifically, the ANNA-B4 module can be powered by connecting an external supply directly to J22, pin 1 and GND. For more information about connecting external power supplies, see also [Measuring current consumption](#).

- Make sure that unpowered parts of the board are properly isolated from the ANNA module. If a voltage is applied to the signal of an unpowered device/component, current might leak through various protection circuits of this device. This might give false readings when measuring current consumption. Isolation can be achieved by removing ANNA signal jumpers. See also [Disconnecting ANNA signals from board peripherals](#).

Figure 11 below shows a few optional jumper connections that can be helpful when supplying the module with an external supply.

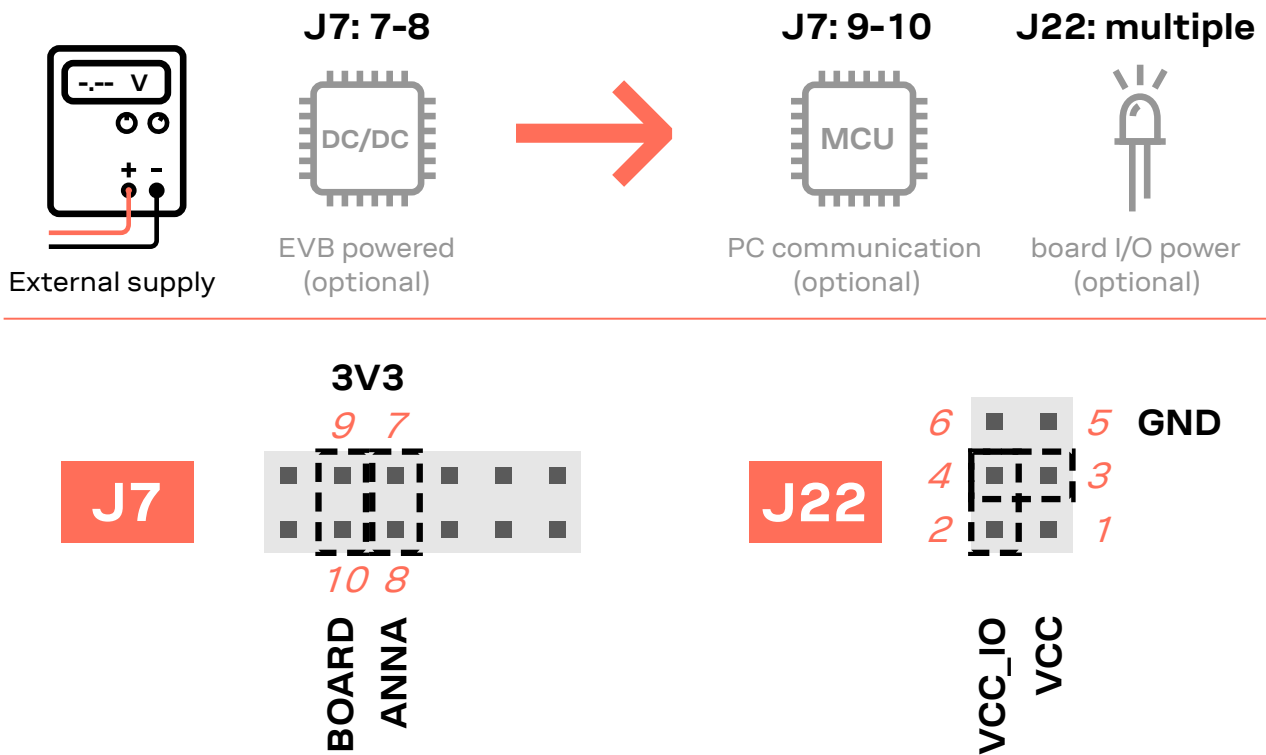

Figure 11: Optional jumper positions while using an external power supply

Connector	Add jumper to pins	Description
J7	7, 8	(Optional) Selects the board regulated 3.3 V net as a source for the VCC_ANNA net.
	9, 10	(Optional) Powers up the Interface MCU, USB hub, and UART to USB converter with 3.3 V.
J22	3, 4	(Optional) Powers up the peripherals directly connected to ANNA such as LEDs and external memory with the selected source for the VCC_ANNA net.

Table 6: Optional jumper positions while using an external supply

4.1.6 Raspberry Pi HAT

When connecting a HAT to the Raspberry Pi interface, the following jumper configuration can be used as shown in [Figure 12](#). Depending on how the ANNA module is to communicate with a test PC over USB or with the HAT, the **VDD_MCU** net could be left unpowered.

⚠ The **3V3_PI** supply net must only be powered when connecting to a Raspberry Pi expansion board (HAT). If connecting to a Raspberry Pi board, the jumper must be disconnected.

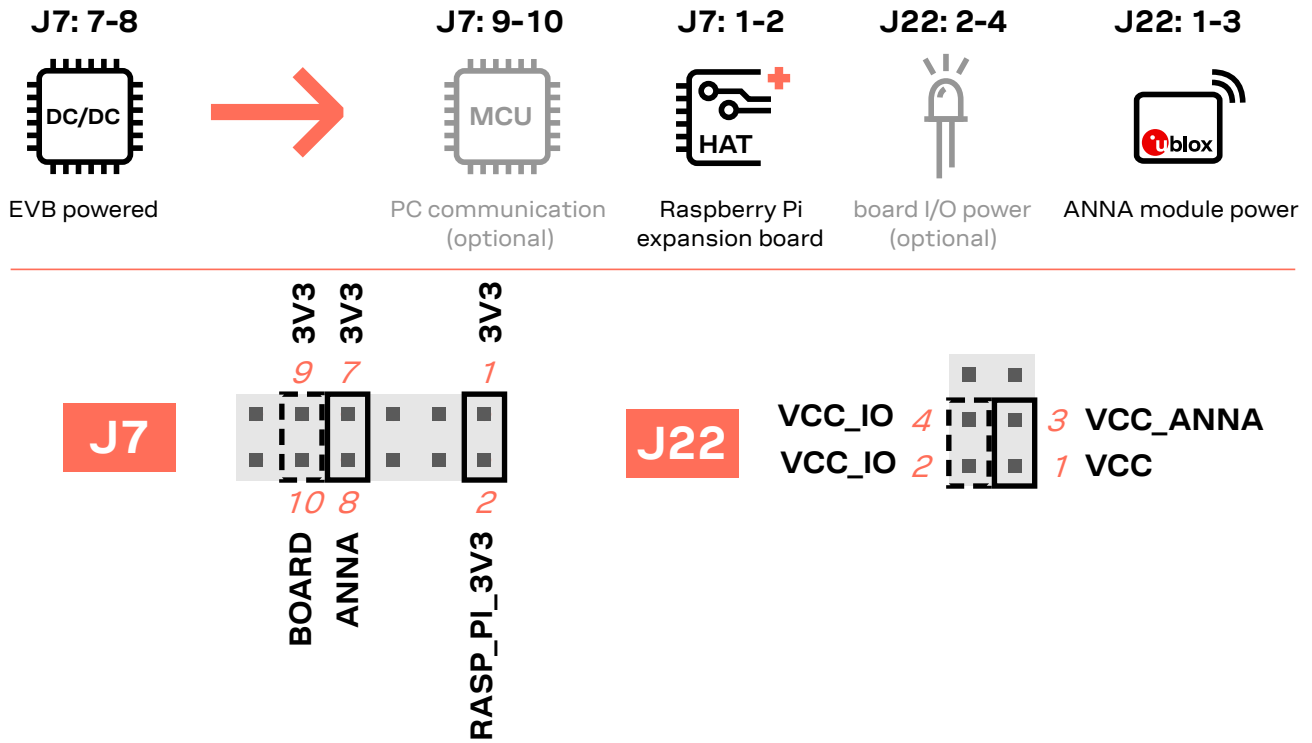

Figure 12: Jumper configuration when connected to a Raspberry Pi HAT (dashed lines show optional jumpers)

Connector	Add jumper to pins	Description
J7	1, 2	Connects the 3V3_PI net to the regulated 3.3 V supply.
	7, 8	Selects the board regulated 3.3 V net as a source for the VCC_ANNA net.
	9, 10	(Optional) Powers up the Interface MCU, USB hub, and UART to USB converter with 3.3 V.
J22	1, 3	Powers up the ANNA module. The ANNA VCC and VCC_IO pins are connected to the selected source for the VCC_ANNA net.
	2, 4	(Optional) Powers up the peripherals directly connected to ANNA such as LEDs and external memory with the ANNA supply voltage.

Table 7: Jumper configuration when connected to a Raspberry Pi HAT

4.2 Disconnecting ANNA signals from board peripherals

All evaluation board peripherals, such as level shifters, LEDs, and the interface MCU are connected to the ANNA-B4 module by default. This might not suit all evaluation scenarios.

All peripherals can be switched off by disconnecting their power supplies, but finer control is needed to isolate specific signals. Consequently, all ANNA module signals that are connected to board peripherals are routed through pin headers. In this way, jumpers can be added or removed to isolate or connect specific signals. [Figure 13](#) shows the layout of the pin headers. See also [Powering options](#).

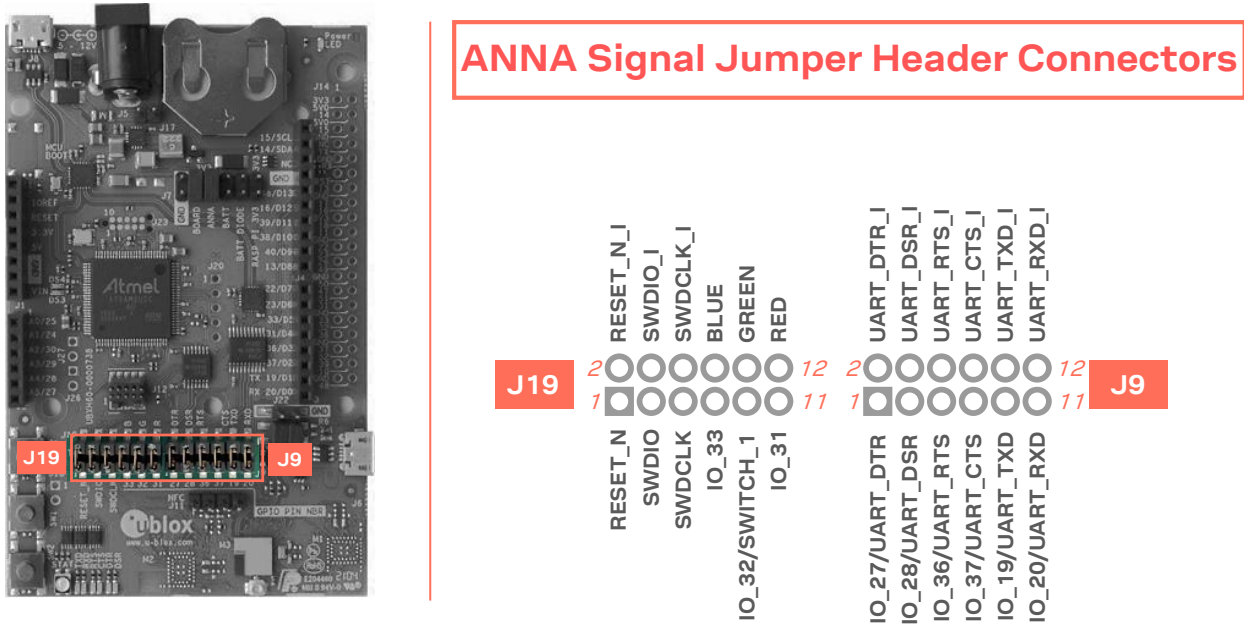

Figure 13: Jumper header connectors J19 and J9 that are used to connect/isolate specific ANNA signals

Connector	Pin no.	Schematic net name	Description
J19	1	RESET_N	ANNA reset signal, active low
	2	RESET_N_I	Connects to the Interface MCU's reset line
	3	SWDIO	SWD data signal
	4	SWDIO_I	Interface MCU SWD data signal, used to program/debug the ANNA module
	5	SWDCLK	SWD clock signal
	6	SWDCLK_I	Interface MCU SWD data signal, used to program/debug the ANNA module
	7	IO_33	ANNA-B402: GPIO, ANNA-B412: BLUE signal
	8	BLUE	RGB diode blue signal, active low
	9	IO_32/ SWITCH_1	ANNA-B402: GPIO, can be used as either user LED output or push-button input ANNA-B412: SWITCH_1 and GREEN signal
	10	GREEN	RGB diode green signal, active low
	11	IO_31	ANNA-B402: GPIO, can be used as user LED output, ANNA-B412: RED signal
	12	RED	RGB diode red signal, active low
J9	1	IO_27/ UART_DTR	ANNA-B402: analog capable GPIO signal ANNA-B412: UART DTR output
	2	UART_DTR_I	UART to USB DTR signal
	3	IO_28/ UART_DSR	ANNA-B402: analog capable GPIO signal ANNA-B412: UART DSR input

Connector	Pin no.	Schematic net name	Description
	4	UART_DSR_I	UART to USB DSR signal
	5	IO_36/ UART_RTS	ANNA-B402: analog capable GPIO signal ANNA-B412: UART RTS output
	6	UART_RTS_I	UART to USB RTS signal
	7	IO_37/ UART_CTS	ANNA-B402: GPIO signal ANNA-B412: UART CTS input
	8	UART_CTS_I	UART to USB CTS signal
	9	IO_19/ UART_TXD	ANNA-B402: GPIO signal ANNA-B412: UART TXD output
	10	UART_TXD_I	UART to USB TXD signal
	11	IO_20/ UART_RXD	ANNA-B402: analog capable GPIO signal ANNA-B412: UART RXD input
	12	UART_RXD_I	UART to USB RXD signal

Table 8: Pinout of the pin header connectors - J19 and J9

5 Interfaces and peripherals

5.1 Buttons and LEDs

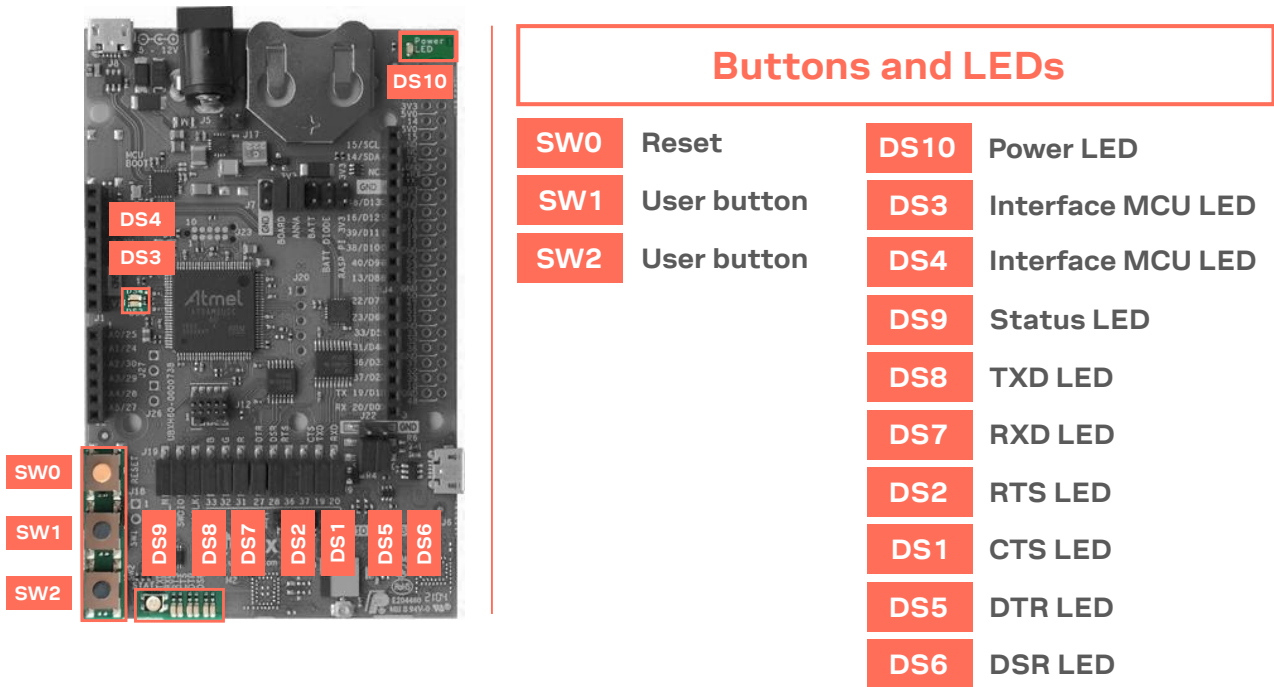

Figure 14: Position of the push buttons and LEDs on the evaluation board

Annotation	Function	Description
SW0	Reset button	Connected directly to the ANNA RESET_N pin.
SW1	User button	Push button for application use. Connected directly to the ANNA SWITCH_1 (IO_32) pin
SW2	User button	Push button for application use. Connected directly to the ANNA SWITCH_2 (IO_40) pin.

Table 9: EVK-ANNA-B4 buttons

Annotation	Function	Description
DS1	CTS LED	Connected to the ANNA UART_CTS (IO_37) pin through pin header connector J9
DS2	RTS LED	Connected to the ANNA UART_RTS (IO_36) pin through pin header connector J9
DS3	Interface MCU LED	Blinks on USB enumeration and activity, lit when the Interface MCU is connected through USB
DS4	Interface MCU LED	Error LED
DS5	DTR LED	Connected to the ANNA UART_DTR (IO_27) pin on pin header connector J9
DS6	DSR LED	Connected to the ANNA UART_DSR (IO_28) pin on pin header connector J9
DS7	RXD LED	Connected to the ANNA UART_RXD (IO_20) pin via pin header connector J9
DS8	TXD LED	Connected to the ANNA UART_TXD (IO_19) pin on pin header connector J9
DS9	Status LED	Connected to the ANNA RED (IO_31), GREEN (IO_32) and BLUE (IO_33) pins on pin header connector J19. The Status LED shows the status for the u-connect applications.
		See also the ANNA-B412 data sheet [3] .
DS10	Power LED	Connected to 3V3 power net.

Table 10: EVK-ANNA-B4 LED indicators

5.2 Arduino interface

EVK-ANNA-B4 includes a set of pin headers and mounting holes that are compatible with certain Arduino or Arduino-inspired shields.

Figure 15 shows the layout of the Arduino interface described in Table 11. For information about the specifications that must be met for a shield to be compatible with the EVK-ANNA-B4, see also [Arduino shield compatibility](#).

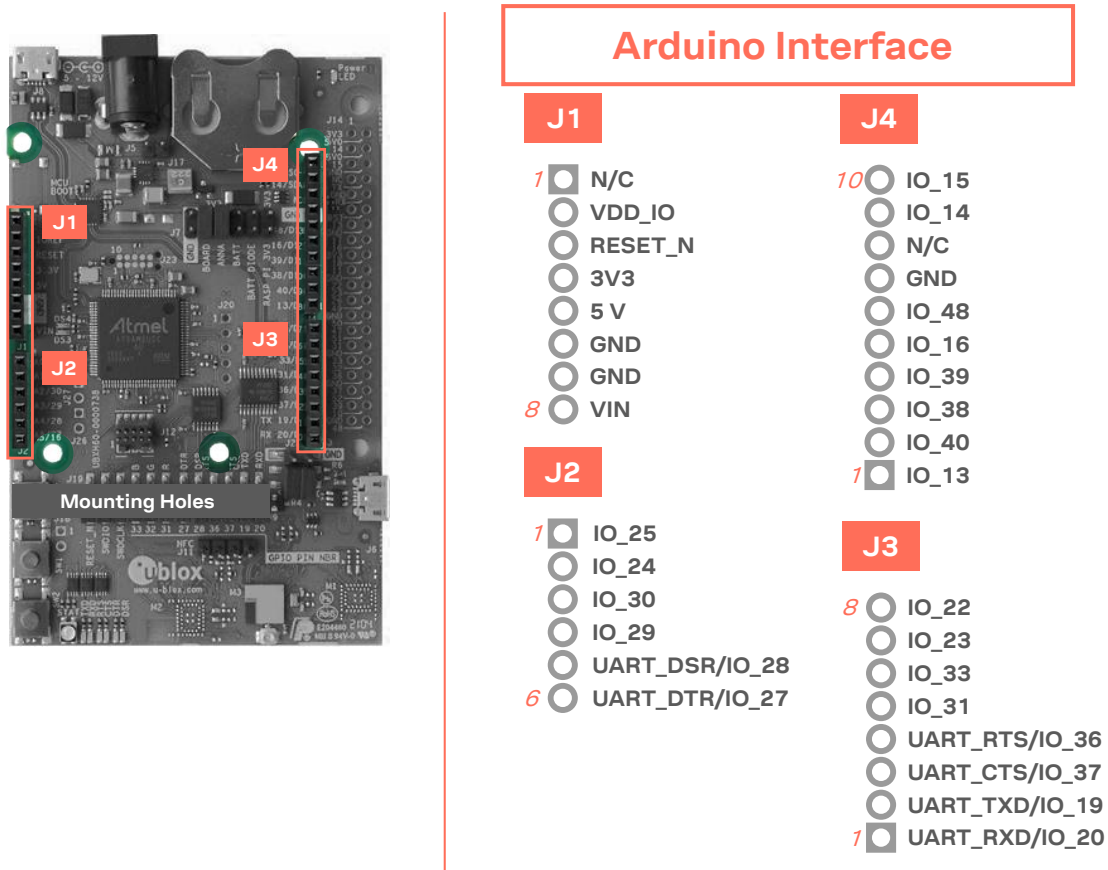



Figure 15: Pin headers that are compatible with some Arduino shields

Conn.	Pin no.	Arduino pin	Description	Schematic net name	nRF52 pin	Alternate functions and notes
J1	1	N/C	Not Connected	-	-	Not connected
	2	IOREF	I/O reference voltage level. Selectable by user to 1.7 – 3.6 V	VDD_IO	-	See also Interfaces and peripherals
	3	RESET	ANNA reset signal input. Active low logic	RESET_N	P0.18	
	4	3.3V	3.3 V DC regulated supply output	3V3	-	
	5	5V	5 V regulated supply output	5V	-	Cannot be used as supply input, use VIN instead. Only supplied by USB VBUS.
	6	GND	Ground	GND	GND	
	7	GND	Ground	GND	GND	

Conn.	Pin no.	Arduino pin	Description	Schematic net name	nRF52 pin	Alternate functions and notes
	8	VIN	External DC supply input, 5 – 12 VDC	VIN	-	
J2	1	A0	Analog input	IO_25	P0.04	Analog function capable GPIO
	2	A1	Analog input	IO_24	P0.05	Analog function capable GPIO
	3	A2	Analog input	IO_30	P0.28	Analog function capable GPIO
	4	A3	Analog input	IO_29	P0.29	Analog function capable GPIO
	5	A4	Analog input	UART_DSR/ IO_28	P0.30	Analog function capable GPIO, UART_DSR signal on ANNA-B41
	6	A5	Analog input	UART_DTR/ IO_27	P0.31	Analog function capable GPIO, UART_DTR signal on ANNA-B41
J3	1	D0/RX	Analog I/O, UART RX	UART_RXD/ IO_20	P0.02	Analog function capable GPIO, UART_RXD signal on ANNA-B41
	2	D1/TX	Analog I/O, UART TX	UART_TXD/ IO_19	P0.03	Analog function capable GPIO, UART_TXD signal on ANNA-B41
	3	D2	Digital I/O	UART_CTS/ IO_37	P0.22	UART_CTS signal on ANNA-B41
	4	D3	Digital I/O	UART_RTS/ IO_36	P0.16	UART_RTS signal on ANNA-B41
	5	D4	Digital I/O	IO_31	P0.27	RED
	6	D5	Digital I/O	IO_33	P0.26	BLUE
	7	D6	Digital I/O	IO_23	P0.10	Signal not connected by default, configured for NFC use
	8	D7	Digital I/O	IO_22	P0.09	Signal not connected by default, configured for NFC use
J4	1	D8	Digital I/O	IO_13	P1.09	
	2	D9	Digital I/O	IO_40	P0.15	SWITCH_2 on ANNA-B41. This signal is pulled low when the button SW2 is pressed
	3	D10	Digital I/O	IO_38	P0.19	
	4	D11	Digital I/O	IO_39	P0.23	
	5	D12	Digital I/O	IO_16	P1.00	
	6	D13	Digital I/O	IO_48	P0.07	
	7	GND	Ground	GND		
	8	AREF	Analog reference voltage level	-	-	Not connected
	9	SDA	I2C data signal	IO_14	P0.11	
	10	SCL	I2C clock signal	IO_15	P0.12	

Table 11: Pinout of the Arduino UNO R3 compatible interface

5.2.1 Arduino shield compatibility

 As EVK-ANNA-B4 has an I/O voltage range of 1.7-3.6 V, it can only be used with shields that support an I/O voltage in this range.

EVK-ANNA-B4 has a pinout that is compatible with some Arduino, or Arduino-inspired, shields.

The characteristics of certain EVK pins demand that shields support the following features:

- **IOREF:** The I/O voltage level of the ANNA-B4 module is 3.3 V by default, but the EVK can be modified to allow other voltages (1.7-3.6 V).
- **RESET:** Is connected to the RESET button (SW0).
- **3V3:** A regulated 3.3 V output. Should not be used as a voltage supply input, use the VIN pin instead.
- **5V:** Is only a 5 V supply output if the EVK is being powered by USB. If any other power configuration is used, this pin will be unconnected (floating). It is safe to connect an external 5 V supply to this pin even when a USB cable is connected. This pin may be used to power the board.
- **VIN:** Can be used as a 5 -12 V supply input to power the EVK-ANNA-B4.
- **Pin 0 (RX):** Is connected to the ANNA-B4 UART RX pin (ANNA pin 20).
- **Pin 1 (TX):** Is connected to the ANNA-B4 UART TX pin (ANNA pin 19).

 **SCL/SDA:** On some Arduino boards, the I2C signals, SCL, and SDA are connected to pins A4 and A5 and to the SCL and SDA pins in the top right-hand corner. Since these pins will be shorted together, this might cause problems when they are connected to the EVK-ANNA-B4 – in which they are not normally shorted.

 **Digital I/O pins:** For serial communication and flashing/debugging over USB, some digital I/O pins can be connected to the on-board debug MCU. In these instances, the connected pins can cause some interference on the signals that are also used by an Arduino shield. For information about disconnecting these signals from the debug MCU. See also [Disconnecting ANNA signals from board peripherals](#).

5.3 Raspberry Pi compatible interface

EVK-ANNA-B4 includes a 33-pin GPIO header that can be used to interface with either a Raspberry Pi computer board or Raspberry Pi Hardware Attached on Top (HAT) expander.

EVK-ANNA-B4 uses different hardware and software configurations depending on whether it is connected to a Pi or HAT. The default configuration is for connection to a P computer board. Compatible Raspberry Pi versions are described in [Table 12](#).

 Older Pi and HAT versions that do not use a 40-pin GPIO header are not supported.

Compatible Raspberry Pi boards
Raspberry Pi 1 Model A+
Raspberry Pi 1 Model B+
Raspberry Pi 2 Model B
Raspberry Pi 3 Model B
Raspberry Pi Zero
Raspberry Pi Zero W

Table 12: Compatible Raspberry Pi boards

Figure 16 shows the layout of the Raspberry Pi interface described in Table 13. Three mounting holes can be used for increasing the mechanical stability. The two holes on each side of connector J14 are common to all Raspberry Pi boards, but the third one is only compatible with the Pi Zero boards.

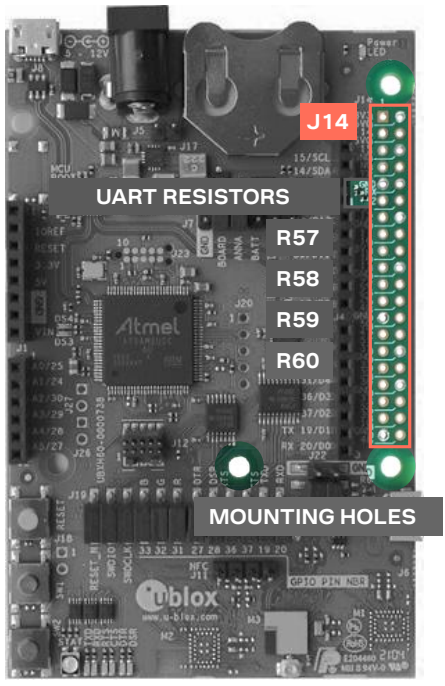

Raspberry Pi Interface

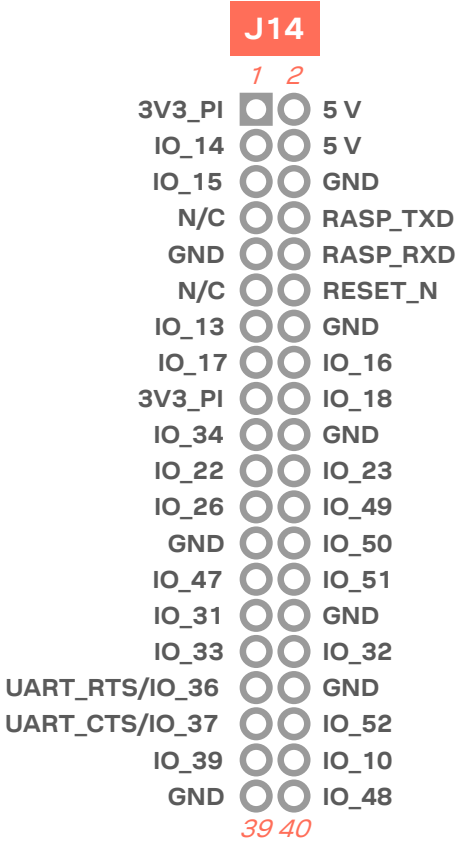

Figure 16: Pin header J14 that is compatible with the Raspberry Pi GPIO connectors

Conn.	Pin No.	Raspberry Pi pin	Description	Schematic net name	nRF52 pin	Alternate functions and notes
J14	1	3.3 V	3.3 V supply pin	3V3_PI	-	Not connected by default, see also Powering options .
	2	5 V	5 V supply pin	5V	-	Cannot be used as supply input. Supplied by USB VBUS and protected from back powering.
	3	GPIO02	Digital I/O	IO_14	P0.11	
	4	5 V	5 V supply pin	5V	-	Cannot be used as supply input. Supplied by USB VBUS and protected from back powering.
	5	GPIO03	Digital I/O	IO_15	P0.12	
	6	GND	Ground	GND	GND	
	7	GPIO04	Digital I/O	-	-	N/C

Conn. No.	Raspberry Pi pin	Description	Schematic net name	nRF52 pin	Alternate functions and notes
8	GPIO14	Digital I/O, UART TX/RX	RASP_TXD	P0.02	Connected to ANNA UART_RXD pin by default. See also UART .
9	GND	Ground	GND	GND	
10	GPIO15	Digital I/O, UART RX/TX	RASP_RXD	P0.03	Connected to ANNA UART_TXD pin by default. See also UART
11	GPIO17	Digital I/O	-	-	N/C
12	GPIO18	Digital I/O	RESET_N	P0.18	
13	GPIO27	Digital I/O	IO_13	P1.09	
14	GND	Ground	GND	GND	
15	GPIO22	Digital I/O	IO_17	P0.00	Can be connected to IO_17 via 0 Ω resistor. Resistor not mounted by default. IO_17 is connected to 32.768 LPO crystal by default
16	GPIO23	Digital I/O	IO_16	P1.00	
17	3.3 V	3.3 V supply pin	3V3_PI	-	Not connected by default, see Powering options .
18	GPIO24	Digital I/O	IO_18	P0.01	
19	GPIO10	Digital I/O	IO_11	P0.14	
20	GND	Ground	GND	GND	
21	GPIO09	Digital I/O	IO_22	P0.09	Can be connected to IO_22 via 0 Ω resistor. Resistor not mounted by default. IO_22 is connected to NFC antenna by default
22	GPIO25	Digital I/O	IO_23	P0.10	Can be connected to IO_23 via 0 Ω resistor. Resistor not mounted by default. IO_23 is connected to NFC antenna by default
23	GPIO11	Digital I/O	IO_26	P0.21	
24	GPIO08	Digital I/O	IO_49	P0.17	
25	GND	Ground	GND	GND	
26	GPIO07	Digital I/O	IO_50	P0.08	
27	ID_SD	EEPROM config I2C data signal	IO_47	P1.07	Can only be used to read or simulate HAT EEPROMs. See also EEPROM support .
28	ID_SC	EEPROM config I2C clock signal	IO_51	P1.01	Can only be used to read or simulate HAT EEPROMs See also EEPROM support .
29	GPIO05	Digital I/O	IO_31	P0.27	
30	GND	Ground	GND	GND	
31	GPIO06	Digital I/O	IO_33	P0.26	
32	GPIO12	Digital I/O	IO_32	P0.06	
33	GPIO13	Digital I/O	UART_RTS	P0.16	
34	GND	Ground	GND	GND	
35	GPIO19	Digital I/O	UART_CTS	P0.22	
36	GPIO16	Digital I/O	IO_52	P0.13	
37	GPIO26	Digital I/O	IO_39	P0.23	
38	GPIO20	Digital I/O	IO_10	P0.20	
39	GND	Ground	GND	GND	
40	GPIO21	Digital I/O	IO_48	P0.07	

Table 13: Pinout of the Raspberry Pi compatible interface

5.3.1 Powering considerations

Two voltage nets are used in the Raspberry Pi interface, **3V3_PI** and **5V**. Both the **3V3_PI** and **5V** nets can be used to power HATs, but these nets should not be used when connecting to a Raspberry Pi. See also [Raspberry Pi HAT](#).

- ⚠ Do not connect the **3V3_PI** power net to the 3.3 V supply when connected to a Raspberry Pi board. Failure to observe this can cause serious damage to both boards.

5.3.2 UART

The Raspberry Pi interface provides two pins that can be used for UART communications **GPIO14** and **GPIO15**.

In UART communications, signals are always connected RX <-> TX and vice-versa. This means that **GPIO14** is TX on a Raspberry Pi board, but RX on a HAT. To support communication with both HATs and Pi boards, the 0 Ω resistors (R57, R58, R59 and R60) can be used to toggle the ANNA TX and RX pins between **GPIO14** and **GPIO15**. If ANNA-B402x is used, this switch can also be made in the software. By default, the EVK-ANNA-B4 is configured to simulate a HAT, with **GPIO14** connected to the ANNA **UART_RXD** pin and **GPIO15** connected to the ANNA **UART_TXD** pin.

5.3.3 EEPROM support

The Raspberry Pi interface supports a unique EEPROM solution that stores the HAT specific GPIO configurations on the HAT board. The Raspberry Pi reads the configurations before configuring its GPIOs. The two pins used for this, **ID_SD** and **ID_SC**, are connected to the ANNA-B4 module. In this way, the ANNA module can either read the GPIO configuration from a HAT or simulate an EEPROM and send configurations to a connected Pi. This requires ANNA-B402 module and a custom-built application.

The EEPROM solution is not mandatory. If this approach considered inappropriate, do not configure **IO_47** and **GPIO_51**.

For more information on the ID EEPROM specification, see the [raspberrypi/hats](#) pages at GitHub.

5.4 Additional Interfaces

In addition to the normal interfaces that are most used, several other few expansion options are available to the user. These extra interfaces require some modifications to the EVB before they can be used.

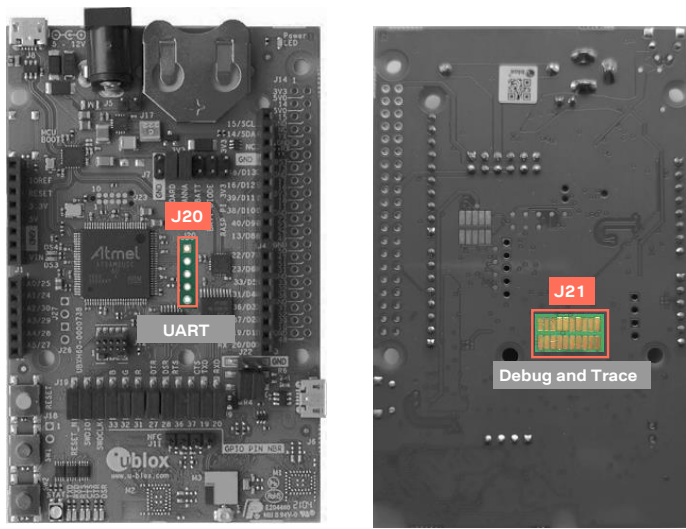

Additional Interfaces

UART

J20

- 1 MCU_TXD
- 2 MCU_RXD
- 3 MCU_CTS
- 4 MCU_RTS
- 5 GND

Debug and Trace

J21

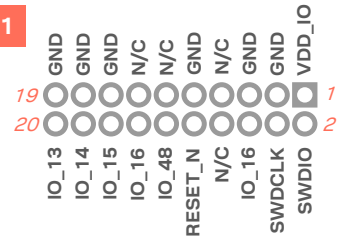

Figure 17: Additional interfaces that require some soldering before use

Connector annotation	Pin number	Schematic net name	nRF52 pin	Description
J20	1	MCU_TXD	-	Interface MCU data output signal
	2	MCU_RXD	-	Interface MCU data input signal
	3	MCU_CTS	-	Interface MCU flow control input signal
	4	MCU_RTS	-	Interface MCU flow control output signal
	5	GND	GND	Ground
<i>Note: Please refer to the MCU pins for signal naming. Net names on J20 might be incorrect.</i>				
J21	1	VDD_IO	-	Supply net for LEDs and peripherals connected directly to the ANNA module. Supply for the external memory chip.
	2	SWDIO	SWDIO	Serial Wire Debug data I/O signal
	3	GND	GND	Ground
	4	SWDCLK	SWDCLK	Serial Wire Debug clock signal
	5	GND	GND	Ground
	6	TRACE_DATA0/SWO/IO_16	P1.00	Serial trace data signal / Parallel trace data signal
	7	N/C	-	Not connected
	8	N/C	-	Not connected
	9	GND	GND	Ground
	10	RESET_N	P0.18	ANNA reset signal, active low
	11	N/C	-	Not connected
	12	TRACE_CLK/IO_48	P0.07	Parallel trace clock signal
	13	N/C	-	Not connected
	14	TRACE_DATA0/SWO/IO_16	P1.00	Serial trace data signal / Parallel trace data signal
	15	GND	GND	Ground
	16	TRACE_DATA1/IO_15	P0.12	Parallel trace data signal

Connector annotation	Pin number	Schematic net name	nRF52 pin	Description
	17	GND	GND	Ground
	18	TRACE_DATA2/IO_14	P0.11	Parallel trace data signal
	19	GND	GND	Ground
	20	TRACE_DATA3/IO_13	P1.09	Parallel trace data signal

Table 14: Pinout of the additional interfaces

5.4.1 Extra USB to UART interface

If the evaluation board is connected to a PC using the USB connector J8, two serial COM ports are available. The COM port labeled “JLink CDC UART” (on a Windows PC) is not normally connected to anything but is routed as a 4-pin UART interface to the pin header J20. This interface could be connected to a secondary UART interface on the ANNA-B4 module, or to a UART interface on an Arduino shield for example.

5.4.2 CPU trace interface

The Arm® Cortex®-M4F processor in ANNA-B4 modules supports tracing of CPU instructions through the 20-pin, 50 mil pitch, Cortex Debug + ETM connector. This extended connector has the same features as J12, but also accommodates instruction trace operations through the Embedded Trace Macrocell (ETM) of the Cortex-M4 microcontroller in the ANNA-B4 module. A special external debugger is required for tracing instructions through this connector.

 Note that the 50 mil pitch pin header is not soldered onto the evaluation board by default.

Appendix

A Schematics

Pages 2 and 6 of the schematic are intentionally omitted.

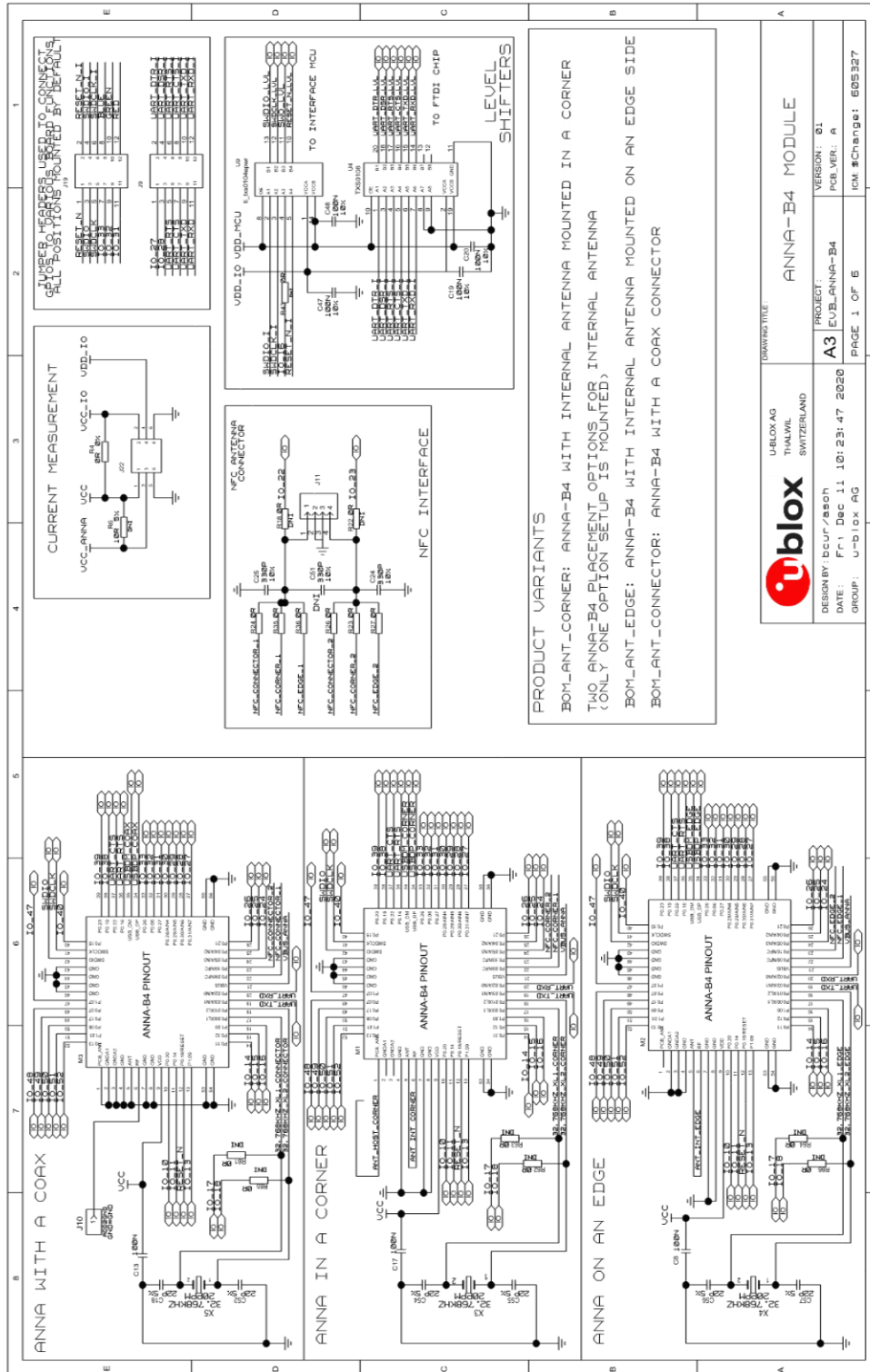
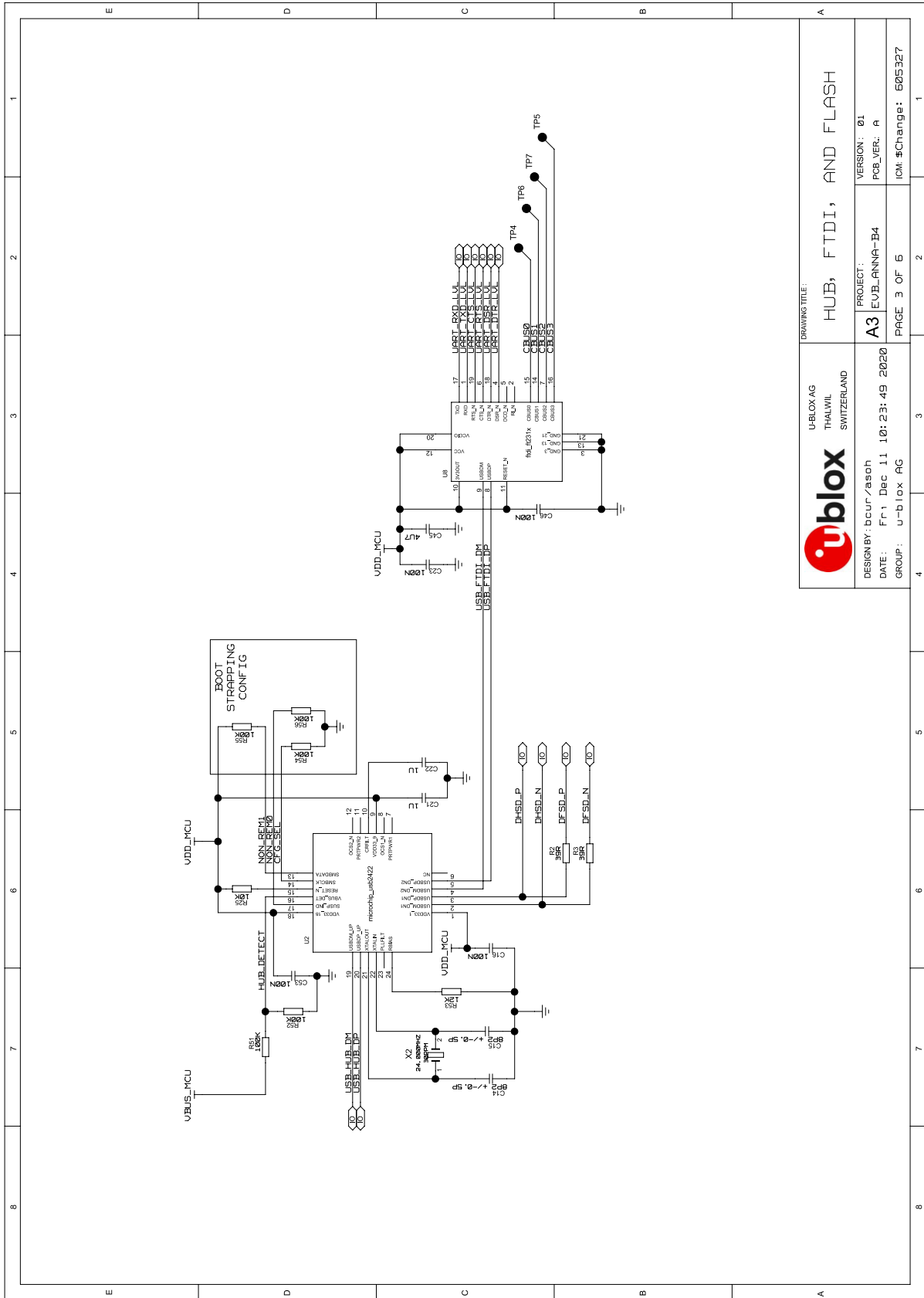

Figure 18: ANNA-B4 module schematic



Figure 19: Interface MCU



 UBLOX AG THALWIL SWITZERLAND		DRAWING TITLE: HUB, FTDI, AND FLASH	
DESIGN BY: bcur/asch DATE: Fr 1 Dec 11 10:23:49 2020 GROUP: U-BLOX AG		PROJECT: A3 EVB_ANNAB4	
VERSION: 01 PCB_VER.: A		PAGE 3 OF 6	
ICM: \$Change: 605327		1	

Figure 20: ANNA-B4 hub, FTDI and flash schematic

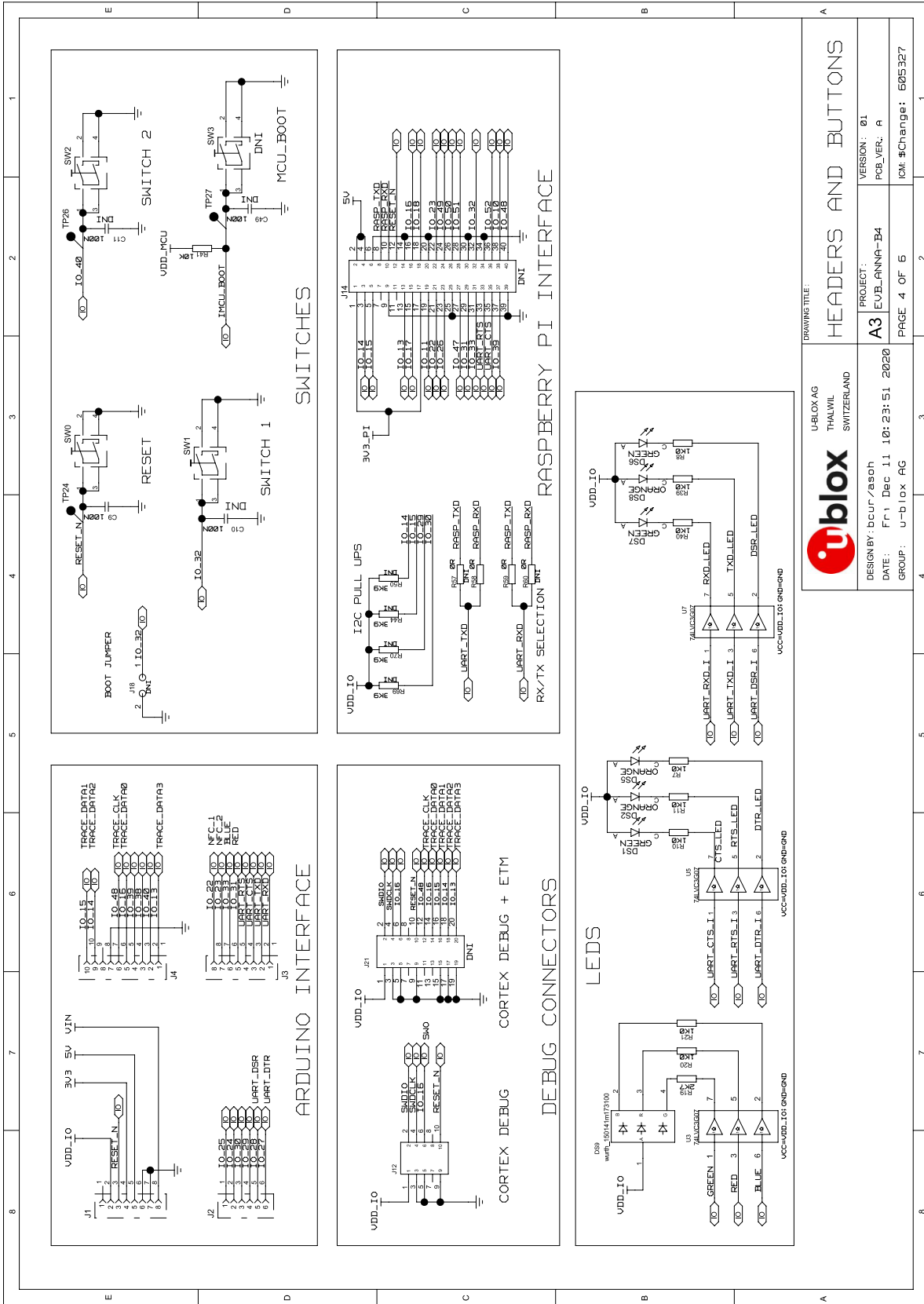

Figure 21: ANNA-B4 headers and buttons schematic

For the first prototype build (marked PT1) EVK-ANNA-B3 schematic can be used as a reference.

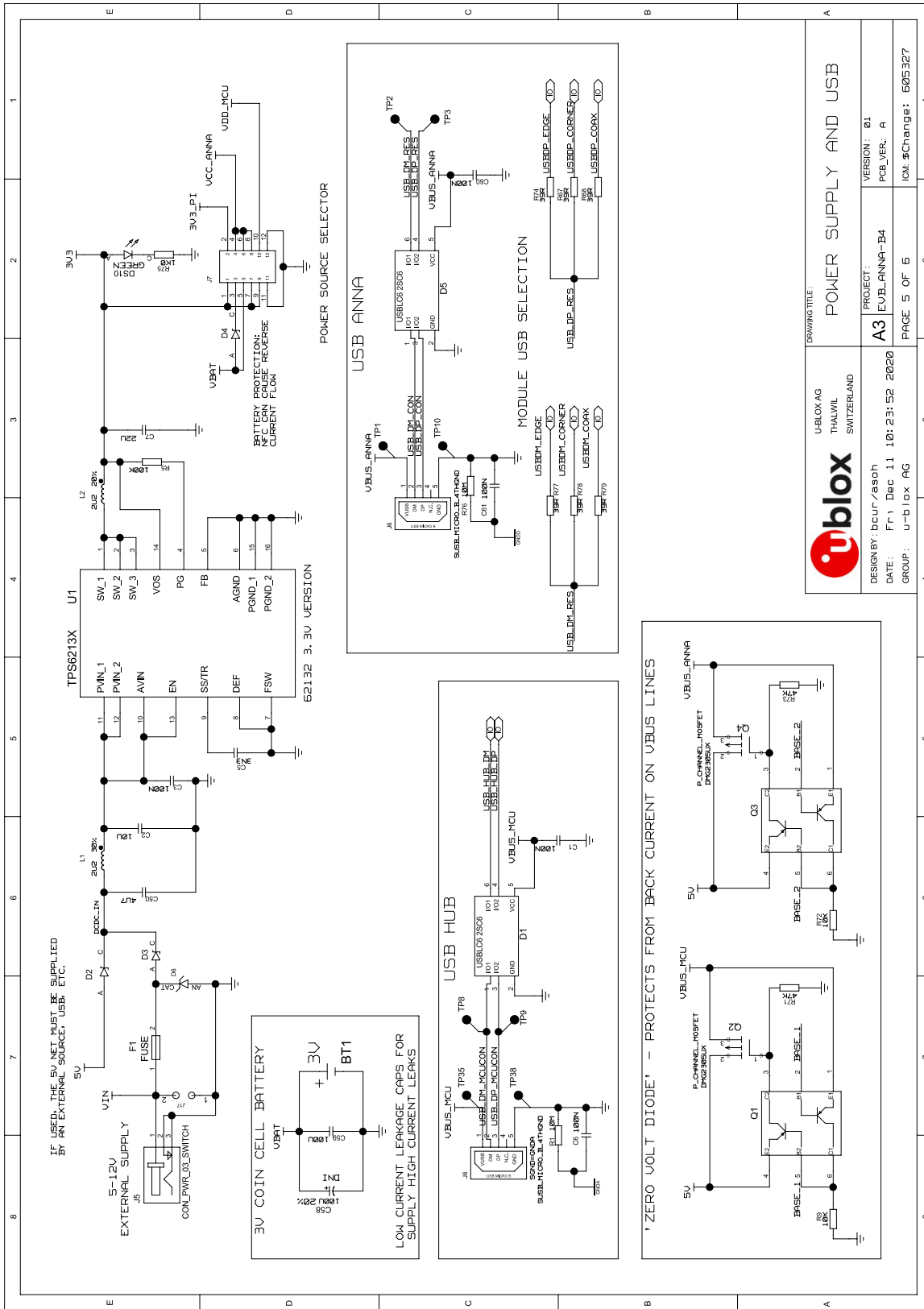

Figure 22:

ANNA-B4 power supply and USB schematic

B Assembly drawings

Top

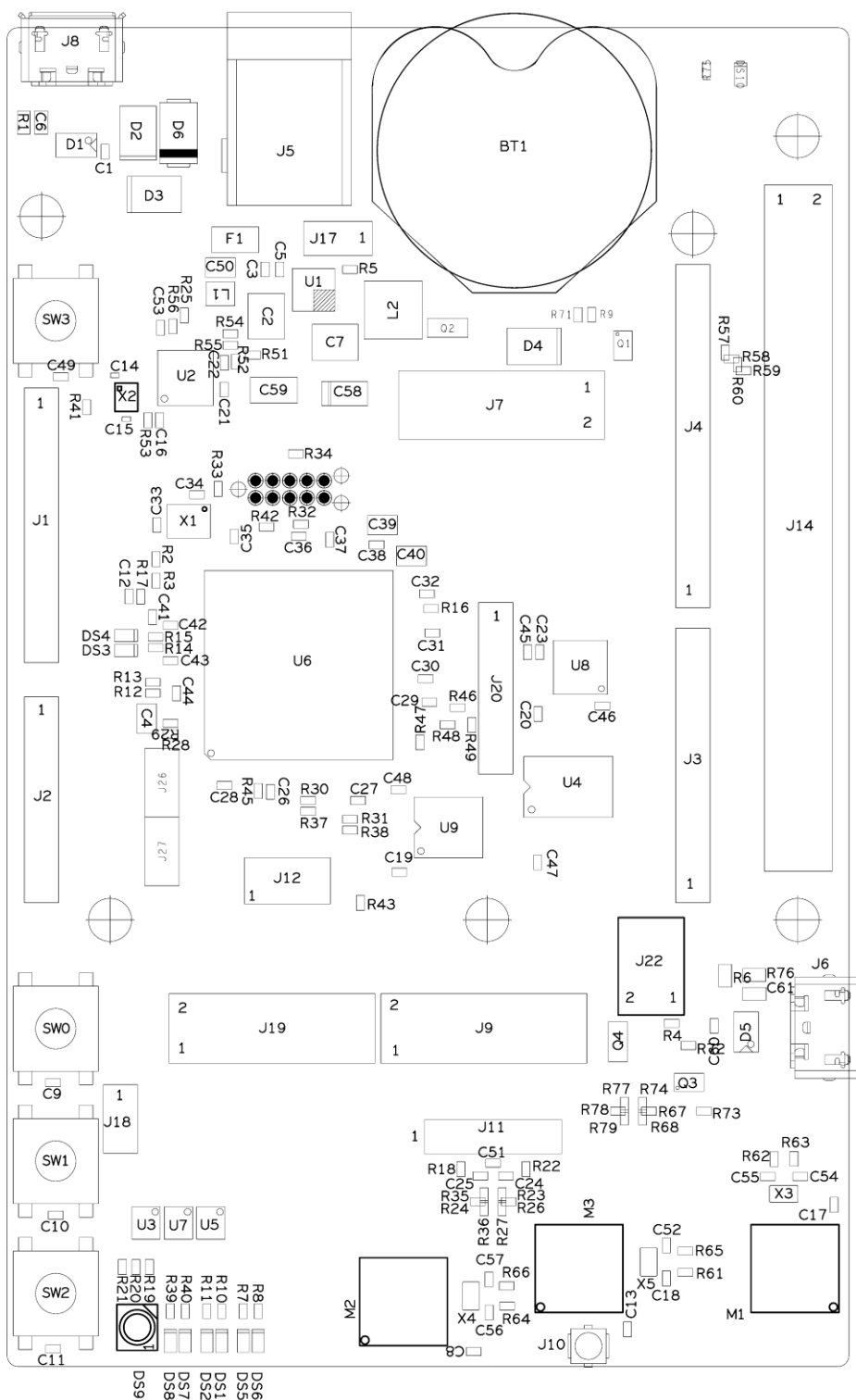

Figure 23: ANNA-B4 assembly drawing – top view

Bottom

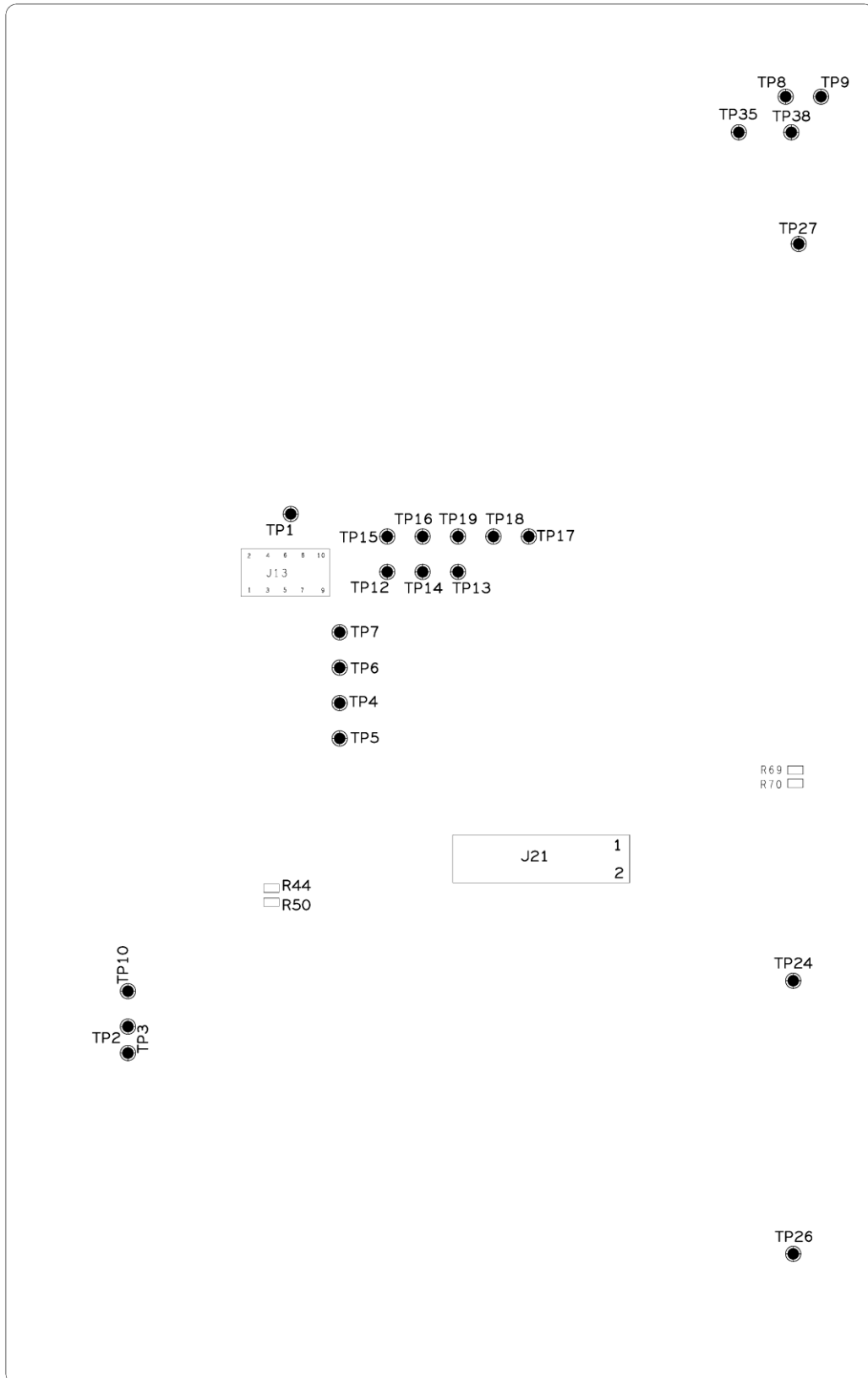

Figure 24: ANNA-B4 assembly drawing – bottom view

C Glossary

Abbreviation	Definition
API	Application programming interface
CTS	Clear To send
EVK	Evaluation kit
GND	Ground
GPIO	General-Purpose Input/Output
HAT	Hardware Attached (on) Top
LED	Light-Emitting Diode
MCU	Micro controller unit
MSD	Mass storage device
NFC	Near Field Communication
U.FL	Coaxial RF connector
USB	Universal serial bus
RTS	Request To send
SDK	Software development kit
SOIC	Small outline integrated circuit
SPA	Serial port application
UART	Universal Asynchronous Receiver/Transmitter

Table 15: Explanation of the abbreviations and terms used

Related documents

- [1] Arduino website, <https://www.arduino.cc>
- [2] Raspberry Pi, <https://www.raspberrypi.org/>
- [3] ANNA-B402 data sheet, [UBX-20032372](#)
- [4] ANNA-B412 data sheet, [UBX-21028698](#)
- [5] ANNA-B4 system integration manual, [UBX-21000517](#)
- [6] u-connectXpress short range AT commands manual, [UBX-14044127](#)
- [7] SEGGER J-Link software, <https://www.segger.com/jlink-software.html>
- [8] u-connectXpress user guide, [UBX-16024251](#)
- [9] u-blox SHO Open CPU GitHub repository, <https://github.com/u-blox/u-blox-sho-OpenCPU>
- [10] FTDI Chip website: <https://ftdichip.com/>



For product change notifications and regular updates of u-blox documentation, register on our website, www.u-blox.com.

Revision history

Revision	Date	Name	Comments
R01	19-July-2021	asoh,yach	Initial release
R02	19-Oct-2021	lalb	Revised metadata and disclosure restriction class
R03	7-Dec-2021	mapc	Added note about UART chip driver installation
R04	02-May-2023	mapc	Added note in Overview to clarify that the Atmel chip is not mounted on u-connectXpress EVKs.

Contact

For further support and contact information, visit us at www.u-blox.com/support.