

RT2872 Step-Down Converter Evaluation Board

Purpose

The RT2872 is a high-efficiency current mode synchronous step-down regulator that can deliver up to 3A output current from a wide input voltage range of 4.5V to 36V. This document explains the function and use of the RT2872 evaluation board (EVB) and provides information to enable operation and modification of the evaluation board and circuit to suit individual requirements.

Table of Contents

Purpose	1
Introduction.....	2
General Product Description	2
Product Features	2
Application.....	2
Evaluation Board	3
Specification	4
Schematic.....	4
BOM.....	5
PCB Layout	6
Step-Down Converter Efficiency Test.....	10
More Information.....	11
Important Notice for Richtek Evaluation Board	11

Introduction

General Product Description

The RT2872 is a high efficiency, current mode synchronous step-down DC/DC converter that can deliver up to 3A output current over a wide input voltage range from 4.5V to 36V. The device integrates a 105mΩ high side and an 80mΩ low side MOSFET to achieve high conversion efficiency up to 95%. The current mode control architecture supports fast transient response and uses a simple compensation circuit.

A cycle-by-cycle current limit function provides protection against a shorted output and an internal soft-start eliminates input surge current during start-up. The RT2872 provides complete protection functions such as input under voltage lockout, output under voltage protection, over current protection and thermal shutdown.

The RT2872 is available in the thermal enhanced SOP-8 (Exposed Pad) package.

Product Features

- **4.5V to 36V Input Voltage Range**
- **3A Output Current**
- **Internal N-MOSFETs**
- **Current Mode Control**
- **Frequency Operation : 300kHz to 1MHz**
- **Adjustable Output Voltage from 0.8V to 30V**
- **High Efficiency Up to 95%**
- **Stable with Low ESR Ceramic Output Capacitors**
- **Cycle-by-Cycle Current Limit**
- **AEC-Q100 Grade 3 Certification**

Application

- **Point of Load Regulator in Distributed Power Systems**
- **Digital Set Top Boxes**
- **Broadband Communications**
- **Vehicle Electronics**
- **Automotive Audio, Navigation, and Information Systems**
- **Enterprise Datacom Platforms Point of Load (POL)**
- **Industrial Grade General Purpose Point of Load**

Evaluation Board

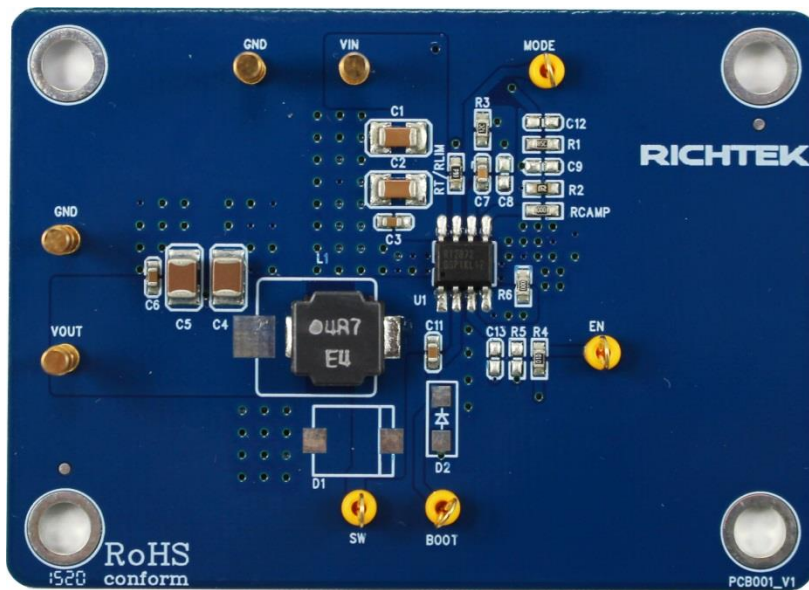

Please carefully inspect the EVB IC and external components, comparing them to the following Bill of Materials, to ensure that all components are installed and undamaged. If any components are missing or damaged during transportation, please contact the distributor or send e-mail to evb_service@richtek.com

Test Points

The EVB is provided with the test points and pin names listed in the table below.

Test point/Pin name	Signal	Comment (expected waveforms or voltage levels on test points)
VIN	Input voltage	Input voltage range = 4.5V to 36V
VOUT	Output voltage	Default output voltage = 3.3V Output voltage range = 0.8V to 30V (see " Output Voltage Setting" section for changing output voltage level)
SW	Switch Node	SW waveform
EN	Chip Enable Operation	Enable signal. EN is automatically pulled high (by R4) to enable operation. Connect EN low to disable operation.
BOOT	Boot strap supply test point	Floating supply voltage for the high-side N-MOSFET switch
MODE	RT test point	Switch frequency setting point
GND	Ground	Ground

Power-up & Measurement Procedure

1. Apply a 12V nominal input power supply ($4.5V < V_{IN} < 36V$) to the VIN and GND terminals.
2. The EN voltage is pulled to logic high by R4 (100kΩ to VIN) to enable operation. Drive EN high (>2.0V) to enable operation or low (<0.4V) to disable operation.
3. Verify the output voltage (approximately 3.3V) between VOUT and GND.
4. Connect an external load up to 3A to the VOUT and GND terminals and verify the output voltage and current.

Output Voltage Setting

Set the output voltage with the resistive divider (R1, R2) between VOUT and GND with the midpoint connected to FB through RCAMP. The output is set by the following formula:

$$V_{OUT} = 0.8 \times \left(1 + \frac{R1}{R2}\right)$$

The installed V_{OUT} capacitors (C4, C5) are 22µF, 16V X5R ceramic types. Do not exceed their operating voltage range and consider their voltage coefficient (capacitance vs. bias voltage) and ensure that the capacitance is sufficient to maintain stability and provide sufficient transient response for your application. This can be verified by checking the output transient response as described in the RT2872 IC datasheet.

Specification

Parameter	Symbol	Min	Typ.	Max	Units
Input Voltage Range	V _{IN}	4.5		36	V
Output Voltage	V _{OUT}		3.3		V
Oscillator Frequency	f _{osc}	300k		1M	Hz
Output Current	I _{OUT}			3	A
High-Side Switch Current Limit Range	U _{OC}	4.25	5	5.75	A

Schematic

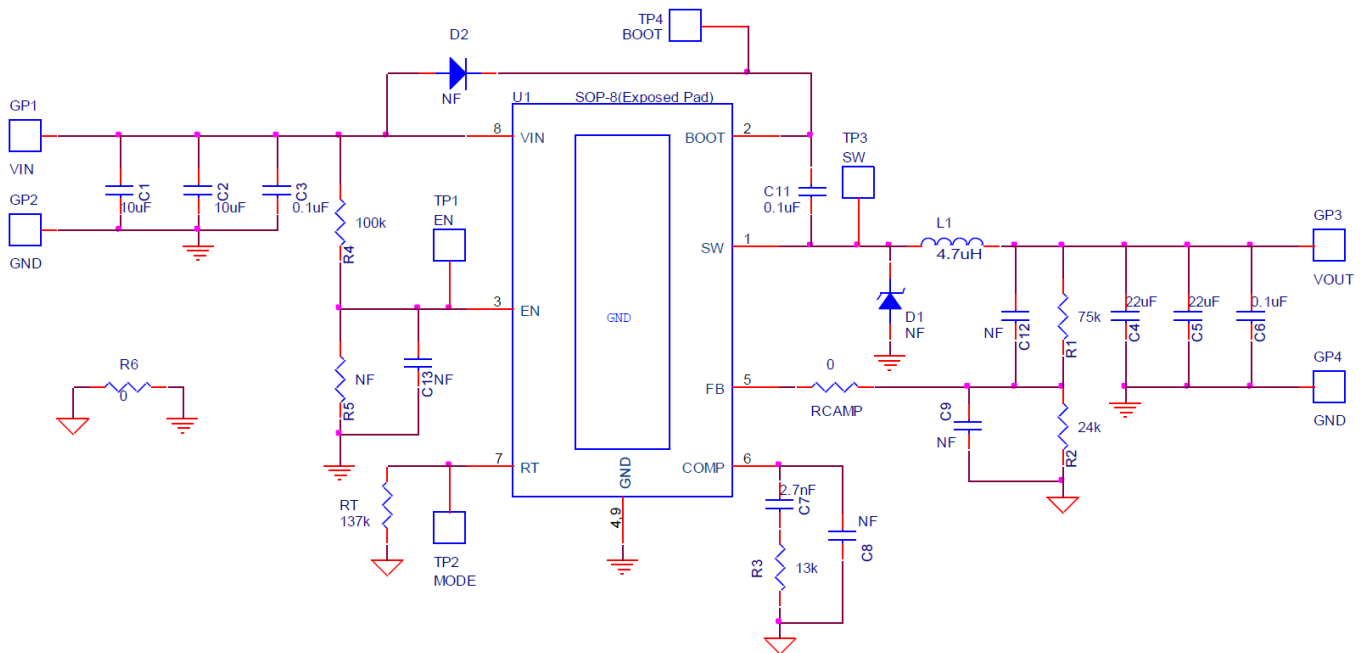

BOM

Reference	Q'ty	P/N	Description	Package	Manufacture
U1	1	RT2872GSP	DC/DC Converter	PSOP-8	Richtek
C1, C2	2	C3216X5R1H106K160AB	10 μ F/ \pm 10%/50V/X5R Ceramic Capacitor	1206	TDK
C4, C5	2	GRM32ER61C226KE20#	22 μ F/ \pm 10%/16V/X5R Ceramic Capacitor	1210	Murata
C7	1	0603B272K500	2.7nF/ \pm 10%/50V/X7R Ceramic Capacitor	0603	WALSIN
C3, C6, C11	3	C1608X7R1H104K080AA	0.1 μ F/ \pm 10%/50V/X7R Ceramic Capacitor	0603	TDK
C8, C9, C12, C13	0		Not Installed	0603	
L1	1	NR8040T4R7N	4.7 μ H/4.1A	8 x 8 x 4.2mm	TAIYO YUDEN
R1	1		75k Ω / \pm 1%, Resistor	0603	
R2	1		24k Ω / \pm 1%, Resistor	0603	
R3	1		13k Ω / \pm 1%, Resistor	0603	
R4	1		100k Ω / \pm 1%, Resistor	0603	
R5, D1, D2	0		Not Installed		
R6, RCAMP	2		0 Ω , Resistor	0603	
RT	1		113k Ω / \pm 1%, Resistor	0603	
TP	4		Test Pin		
GP	4		Golden Pin		

PCB Layout

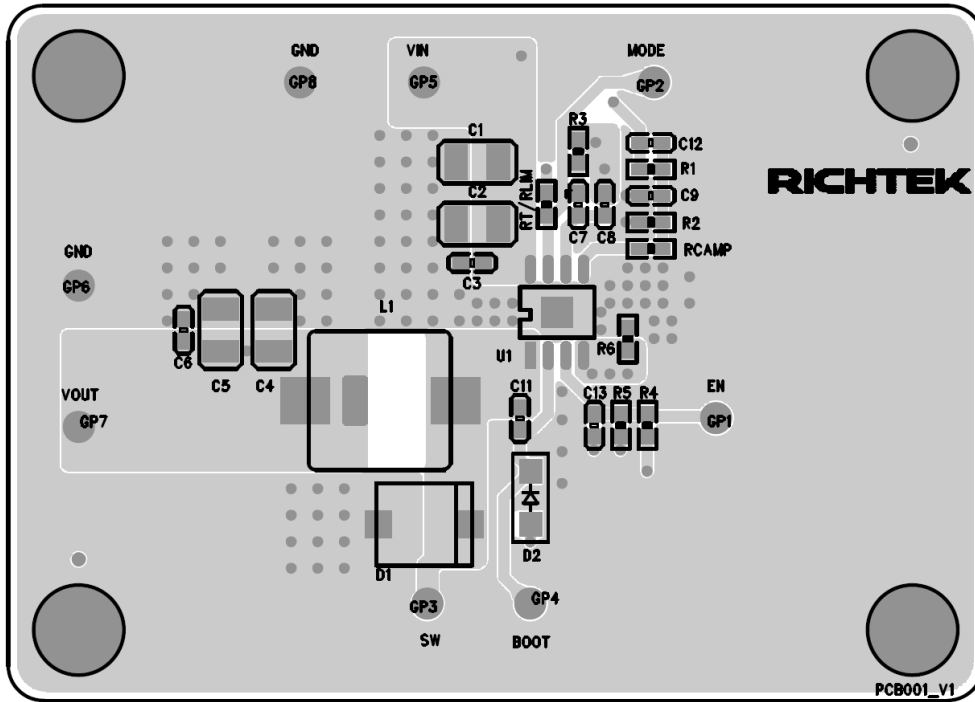

Top View (1st layer)

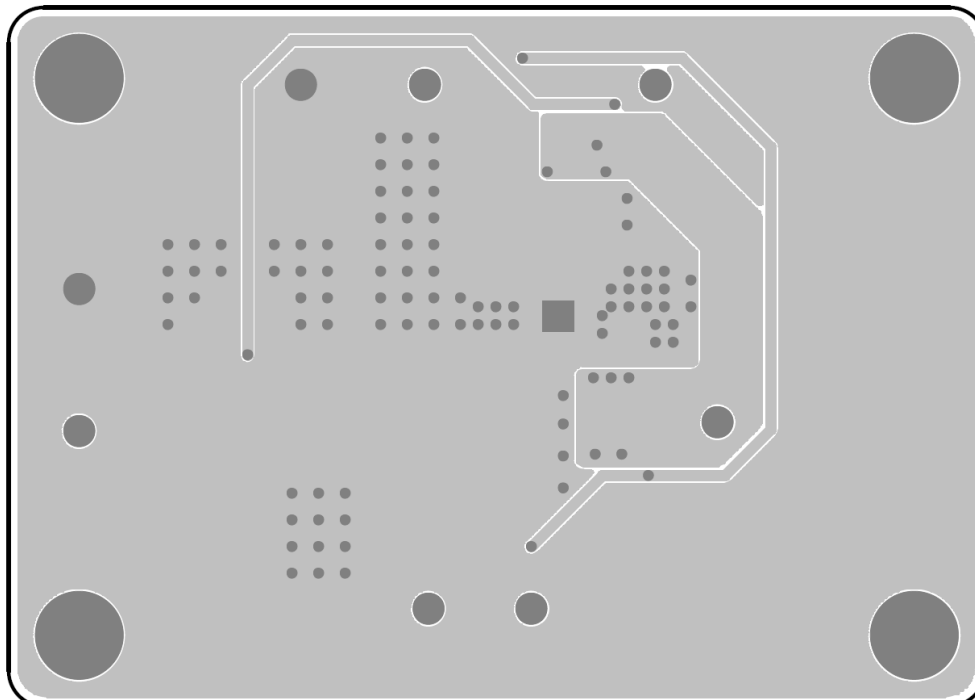

Bottom View (4th Layer)

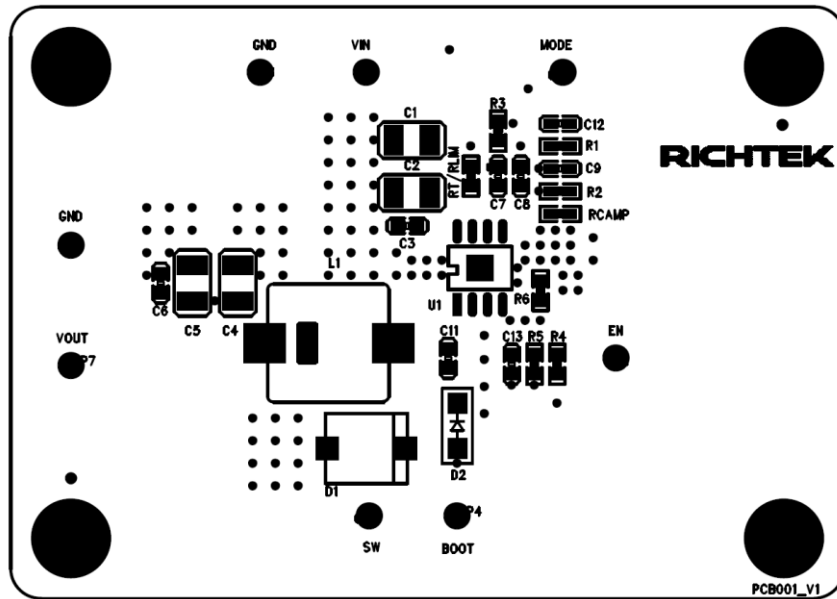

Component Placement Guide—Component Side (1st layer)

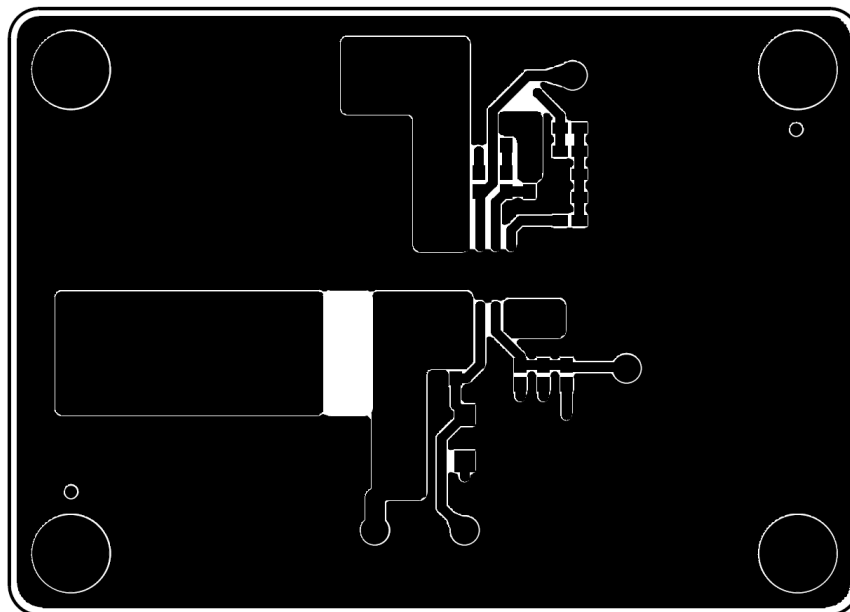

PCB Layout—Component Side (1st Layer)

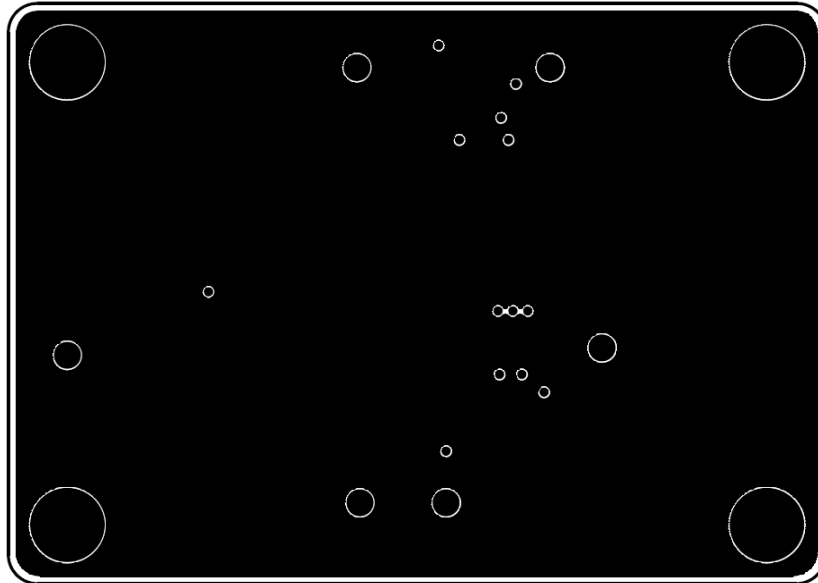

PCB Layout—Inner Side (2nd Layer)

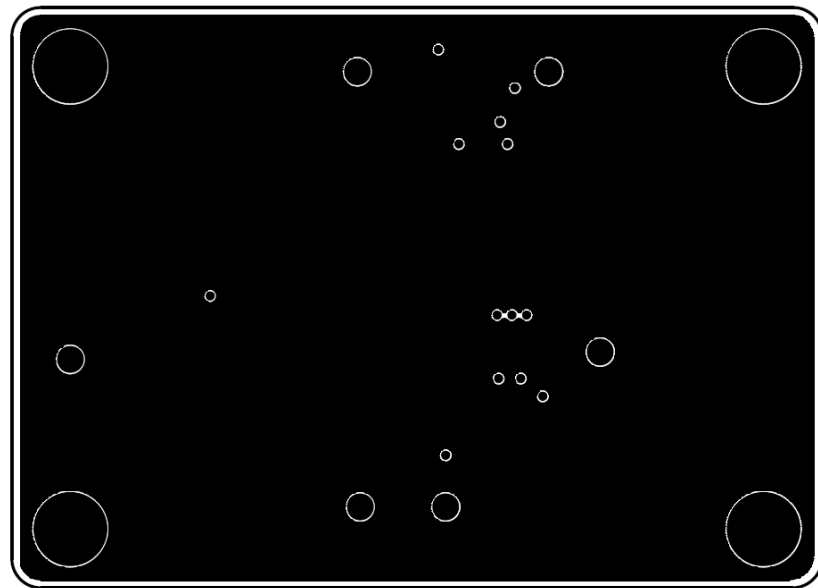

PCB Layout—Inner Side (3rd Layer)

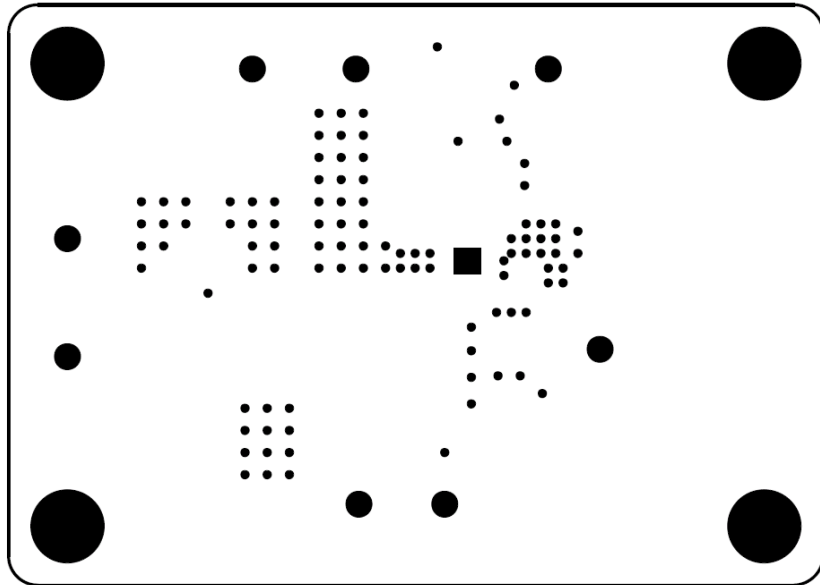

Component Placement Guide—Bottom Side (4th Layer)

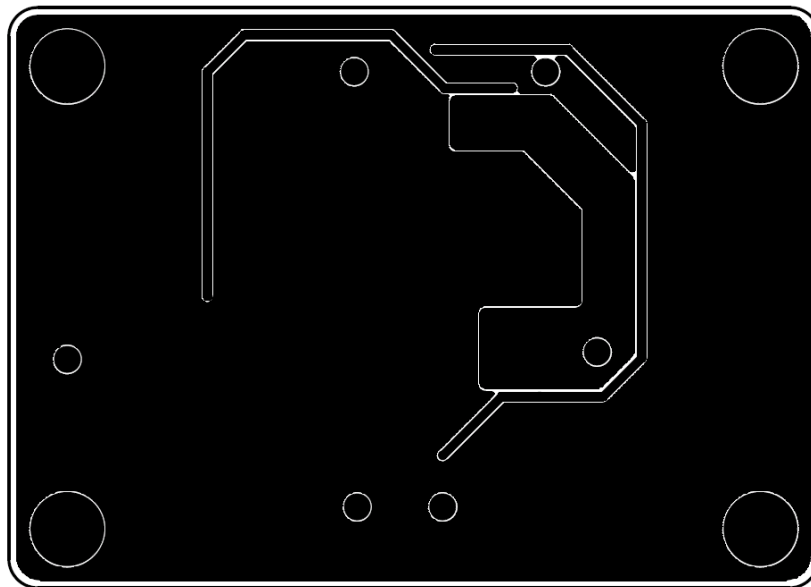

PCB Layout—Bottom Side (4th layer)

Step-Down Converter Efficiency Test

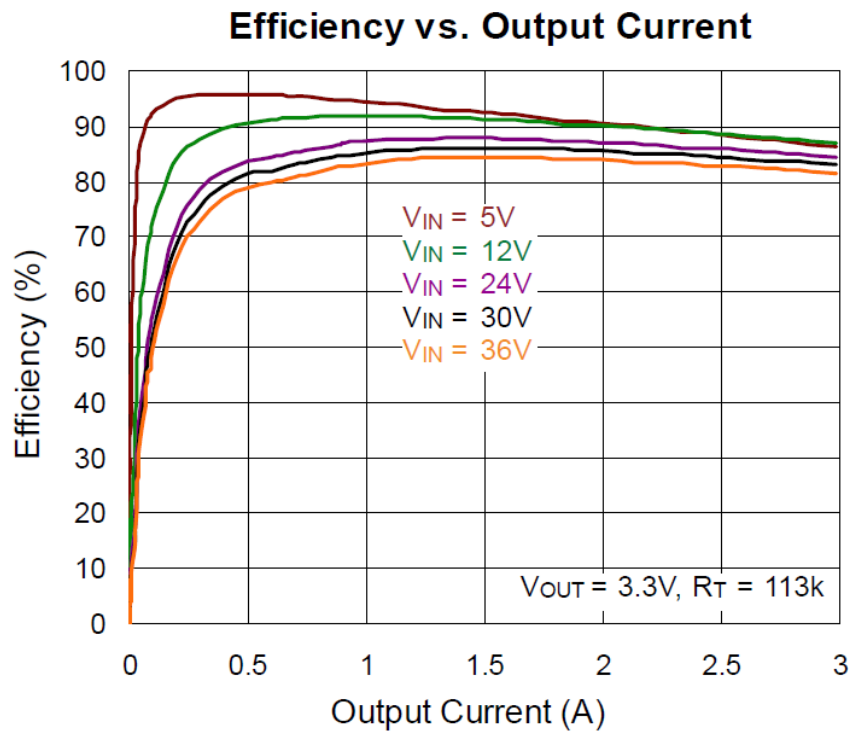

More Information

For more information, please find the related datasheet or application notes from Richtek website <http://www.richtek.com>.

Important Notice for Richtek Evaluation Board

THIS DOCUMENT IS FOR REFERENCE ONLY, NOTHING CONTAINED IN THIS DOCUMENT SHALL BE CONSTRUED AS RICHTEK'S WARRANTY, EXPRESS OR IMPLIED, UNDER CONTRACT, TORT OR STATUTORY, WITH RESPECT TO THE PRESENTATION HEREIN. IN NO EVENT SHALL RICHTEK BE LIABLE TO BUYER OR USER FOR ANY AND ALL DAMAGES INCLUDING WITHOUT LIMITATION TO DIRECT, INDIRECT, SPECIAL, PUNITIVE OR CONSEQUENTIAL DAMAGES.