

NCL30073LED4GEVB

15 W High Power Factor LED Driver Evaluation Board User's Manual



ON Semiconductor®

www.onsemi.com

EVAL BOARD USER'S MANUAL

Overview

This manual covers the specification, theory of operation, testing and construction of the NCL30073LED4GEVB evaluation board. The NCL30073 board demonstrates a 15 W high PF buck boost LED driver for a typical downlight application.

Key Features

The key features of this evaluation board include:

- Low Parts Count
- TRIAC Dimmer Compatible
- High Power Factor
- Integrated Fault Protection
 - ◆ Over Temperature on board (a PCB mounted PTC)
 - ◆ Output Over Current
 - ◆ Output Over Voltage

Table 1. SPECIFICATIONS

Input voltage	207 – 253 V ac	
Line Frequency	50 Hz	
Power Factor (100% Load)	0.9	Min
Output Voltage	72 V dc	
Output Ripple	75%	Pk – Pk
Output Current	200 mA dc	± 5%
Efficiency	88.5%	Typ.
Start Up Time	< 250 msec	Typ.

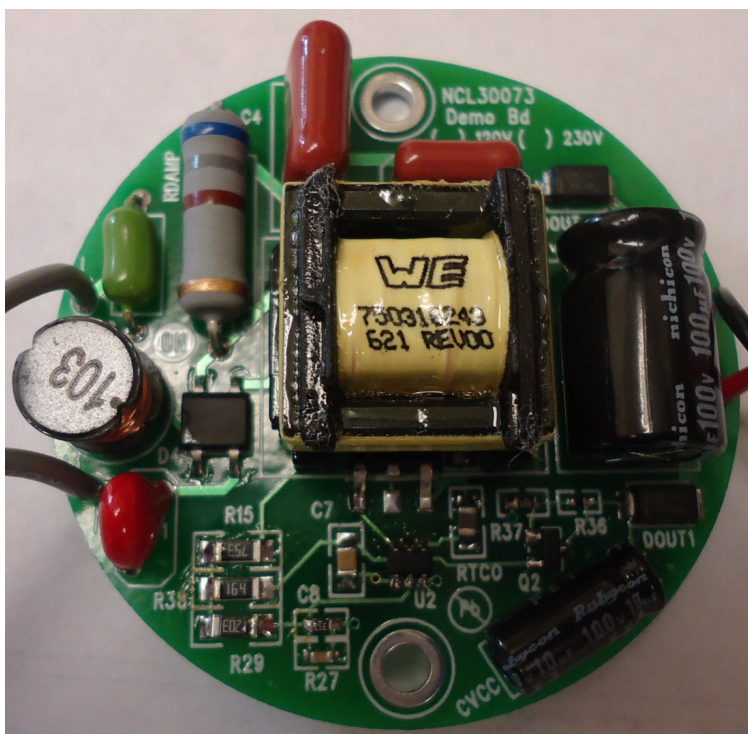

Figure 1. Evaluation Board Photo

NCL30073LED4GEVB

THEORY OF OPERATION

Power Stage

The power stage is a flying buck boost design. In this configuration, drain of the switching FET is connected to the rectified HVDC and the source is switching. This has many benefits:

1. Direct output current sensing
2. Direct output voltage sensing
3. No Aux winding needed

The power stage operates as a fixed frequency DCM power stage. The DCM allows for no forced commutation of the output diode for good EMI performance. The fixed current/fixed frequency provides for a constant power control over a large portion of the input waveform. The resistor divider of R27 and R29 provides some wave shaping to improve the power factor. The input current waveform is made to be square for maximum TRIAC dimmer compatibility.



Figure 2.

Output Voltage Sense and Vcc generation

Dout1 is in parallel with the output during the off time of the FET and stores energy in Cvcc. R36 and R37 divide the output voltage and Q2 buffers it to provide Vcc power to the controller. Since the divider is a fixed ratio, Vcc is a fixed percentage of the output voltage. When Vcc rises above 25 V, the controller detects and OVP fault. The maximum output voltage is set by adjusting the ratio of R36/R37.

In cases where the output has a lot of ripple current and the LED has high dynamic resistance, the peak output voltage can be much higher than the average output voltage. The inductor winding will charge the Cvcc to the peak of the output voltage which may trigger the OVP sooner than expected so in this case the peak voltage of the LED string is critical.

Protection

Thermal Protection

Rtco is a PTC connected between the CS pin and Rsens. The controller creates an internal signal current from the CS pin. As the resistance of Rtco becomes larger with

temperature, the signal level at the CS pin increases causing the current to foldback with temperature.

Programmable OVP

R36 and R37 set Vcc as a fixed percentage of the output voltage. The OVP threshold on the controller is 25 V. So the ratio of R36/R37 is set to trip the Vcc OVP threshold at about 100 V output.

Overcurrent Protection

The controller has built in overcurrent limits.

Output Current

The output current is set by the value of Rsens. It's possible to adjust the output current by changing Rsens.

TRIAC Dimming Compatibility

The EMI filter components are selected to provide optimum damping of the EMI filter to eliminate ringback of the input current which will lead to loss of hold current in the dimmer. The square nature of the input current makes the best case for TRIAC holding current over the line cycle while still maintaining power factor above 0.9.

NCL30073LED4GEVB

SCHEMATIC

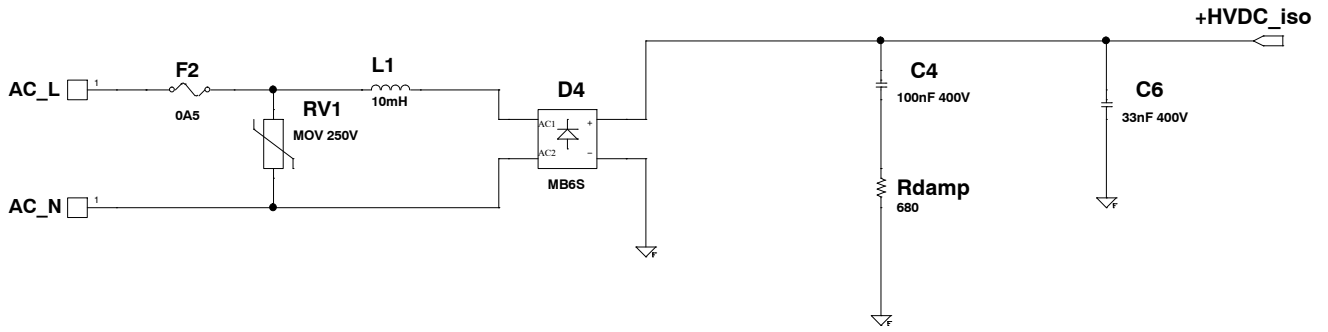

Figure 3. Input Circuit

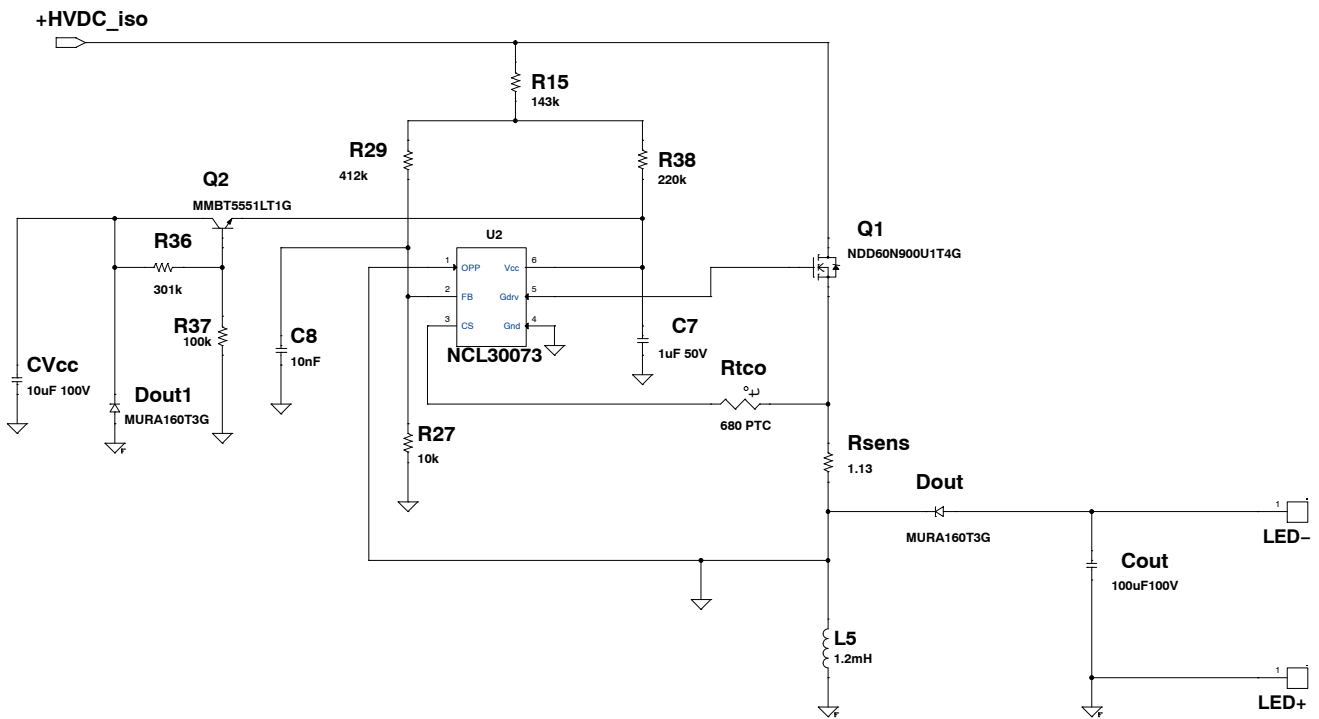

Figure 4. Main Circuit

NCL30073LED4GEVB

BILL OF MATERIAL

Table 2. BILL OF MATERIAL

Reference	Qty	Part	Distributor	Distributor Part Number	Manufacturer	Manufacturer Part Number	Substitution Allowed
CVcc	1	10 μ F 100 V	Rubycon	100YXJ10M5X11	Digikey	1189-2150-ND	Yes
Cout	1	100 μ F 100 V	Nichicon	UVK2A101MPD	Digikey	UVK2A101MPD-ND	Yes
C4	1	100 nF 400 V	Faratronic	C212G104-4B****+++	Faratronic	C212G104-4B****+++	Yes
C6	1	33 nF 400 V	Faratronic	C212G333-3A****+++	Faratronic	C212G333-3A****+++	Yes
C7	1	1 μ F 50 V	Yageo	CC0805KKX7R9BB105	Digikey	311-1886-1-ND	Yes
C8	1	10 nF	Yageo	CC0603KRX7R9BB103	Digikey	311-1085-1-ND	Yes
Dout1, Dout	2	MURA160T3G	ON Semiconductor	MURA160T3G	ON Semiconductor	MURA160T3G	No
D4	1	MB6S	MCC	MB6S	Digikey	MB4S-TPMSCT-ND	Yes
F2	1	0A5	Littelfuse	0263.500WRT1L	Digikey	F1999CT-ND	Yes
L1	1	10 mH	Würth	744772103	Digikey	732-3791-ND	Yes
L5	1	1.2 mH	Würth	750316243	Würth	750316243	Yes
Q1	1	NDD60N900U1T4G	ON Semiconductor	NDD60N900U1T4G	ON Semiconductor	NDD60N900U1T4G	No
Q2	1	MMBT5551LT1G	ON Semiconductor	MMBT5551LT1G	ON Semiconductor	MMBT5551LT1G	No
RV1	1	MOV 250V	Littelfuse	V390ZA05P	Digikey	F3361-ND	Yes
Rdamp	1	680	Yageo	RSF200JB-73-680R	Digikey	680W-2-ND	Yes
Rsens	1	1.13	Yageo	RC1206FR-071R13L	Digikey	311-1.13FRCT-ND	Yes
Rtco	1	680 PTC	Epcos	B59721A90A62	Digikey	495-4312-1-ND	Yes
R15	1	143k	Yageo	RC1206FR-07143KL	Digikey	311-143KFRCT-ND	Yes
R27	1	10k	Yageo	RC0603FR-0710k0L	Digikey	311-10.0KHRCT-ND	Yes
R29	1	412k	Yageo	RC1206FR-07412KL	Digikey	311-412KFRCT-ND	Yes
R36	1	301k	Yageo	RC0603FR-07301KL	Digikey	311-301KHRCT-ND	Yes
R37	1	100k	Yageo	RC0603FR-07100KL	Digikey	311-100KHRCT-ND	Yes
R38	1	220k	Yageo	RC1206FR-07220KL	Digikey	311-220KFRCT-ND	Yes
U2	1	NCL30073	ON Semiconductor	NCL30073	ON Semiconductor	NCL30073	No

NOTE: All components to comply with RoHS 2002/95/EC

NCL30073LED4GEVB

GERBER VIEWS

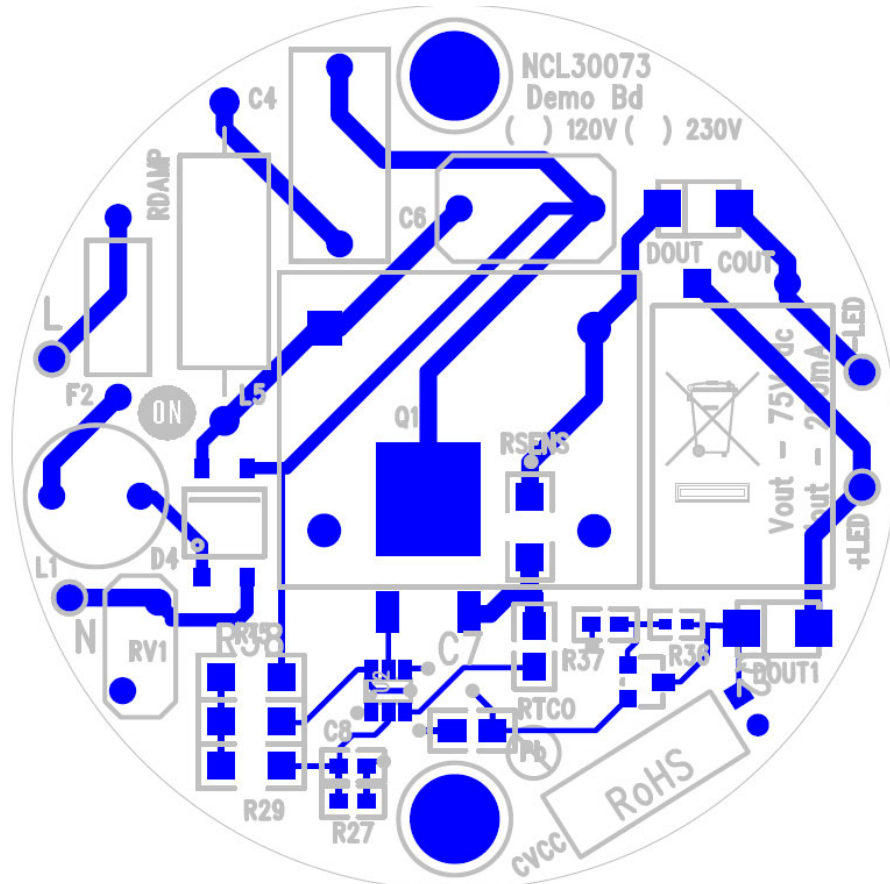

Figure 5. Top Side PCB

NCL30073LED4GEVB

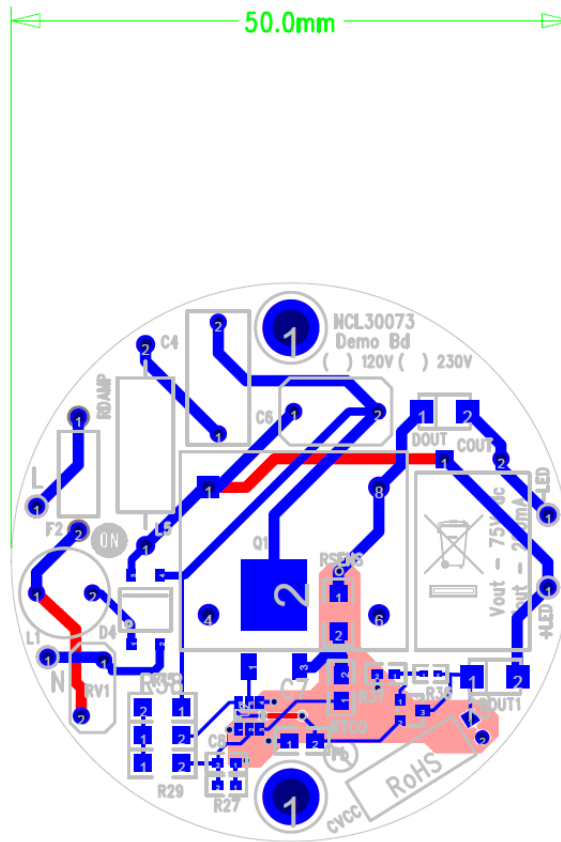

Figure 6. PCB Outline

Circuit Board Fabrication Notes

1. Fabricate per IPC-6011 and IPC6012. Inspect to IPA-A-600 Class 2 or updated standard.
2. Printed Circuit Board is defined by files listed in fileset.
3. Modification to copper within the PCB outline is not allowed without permission, except where noted otherwise. The manufacturer may make adjustments to compensate for manufacturing process, but the final PCB is required to reflect the associated gerber file design ± 0.001 in. for etched features within the PCB outline.
4. Material in accordance with IPC-4101/21, FR4, Tg 125°C min.
5. Layer to layer registration shall not exceed ± 0.004 in.
6. External finished copper conductor thickness shall be 0.0026 in. min. (ie 2oz)
7. Copper plating thickness for through holes shall be 0.0013 in. min. (ie 1oz)
8. All holes sizes are finished hole size.
9. Finished PCB thickness 0.062 in.
10. All un-dimensioned holes to be drilled using the NC drill data.
11. Size tolerance of plated holes: ± 0.003 in. : non-plated holes ± 0.002 in.
12. All holes shall be ± 0.003 in. of their true position U.D.S.
13. Construction to be SMOBC, using liquid photo image (LPI) solder mask in accordance with IPC-SM-B40C, Type B, Class 2, and be green in color.
14. Solder mask mis-registration ± 0.004 in. max.
15. Silkscreen shall be permanent non-conductive white ink.
16. The fabrication process shall be UL approved and the PCB shall have a flammability rating of UL94V0 to be marked on the solder side in silkscreen with date, manufactures approved logo, and type designation.
17. Warp and twist of the PCB shall not exceed 0.0075 in. per in.
18. 100% electrical verification required.
19. Surface finish: electroless nickel immersion gold (ENIG)
20. RoHS 2002/95/EC compliance required.

NCL30073LED4GEVB

ECA PICTURES

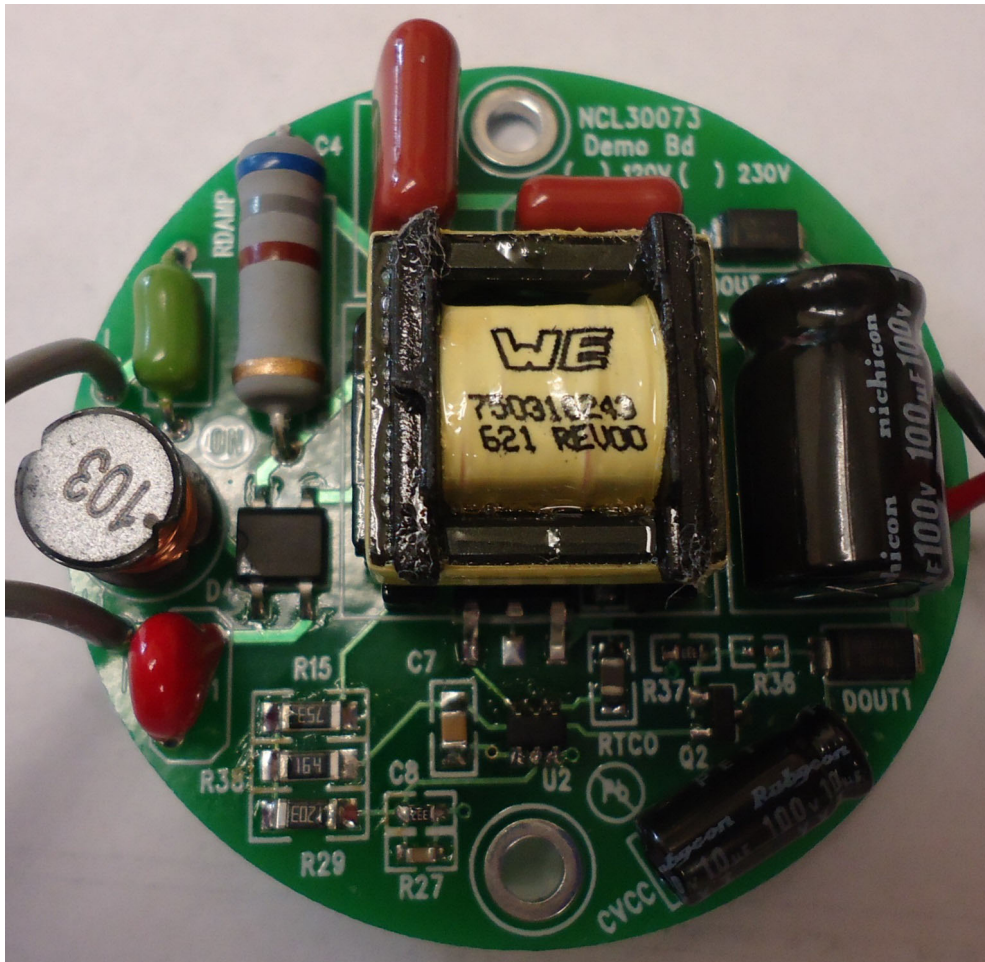

Figure 7. Top View

NCL30073LED4GEVB

TEST PROCEDURE

Equipment Needed

- AC Source – 200 to 260 V ac 50 Hz Minimum 100 W capability
- AC Wattmeter – 100 W Minimum, True RMS Input Voltage, Current, Power Factor, and THD 0.2% accuracy or better
- DC Voltmeter – 300 V dc minimum 0.1% accuracy or better
- DC Ammeter – 1 A dc minimum 0.1% accuracy or better
- LED Load – 70 V – 80 V @ 110 mA

Test Connections

1. Connect the LED Load to the red(+) and black(-) leads through the ammeter shown in Figure 10.
Caution: Observe the correct polarity or the load may be damaged.
2. Connect the AC power to the input of the AC wattmeter shown in Figure 8. Connect the white leads to the output of the AC wattmeter
3. Connect the DC voltmeter as shown in Figure 8.

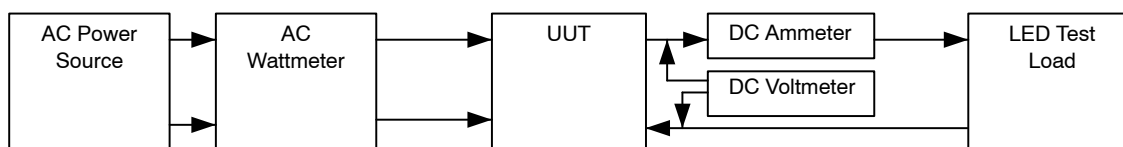

Note: Unless otherwise specified, all voltage measurements are taken at the terminals of the UUT.

Figure 8. Test Set Up

Functional Test Procedure

1. Set the LED Load for 75 V output.
2. Set the input power to 230 V 50 Hz.

Caution: Do not touch the ECA once it is energized because there are hazardous voltages present.

Regulation

230 V / Max Load

Table 3.

	Output Current	Output Power	Power Factor	THD
207 V				
230 V				
253 V				

$$\text{Efficiency} = \frac{V_{\text{out}} \times I_{\text{out}}}{P_{\text{in}}} \times 100\%$$

NCL30073LED4GEVB

TEST DATA

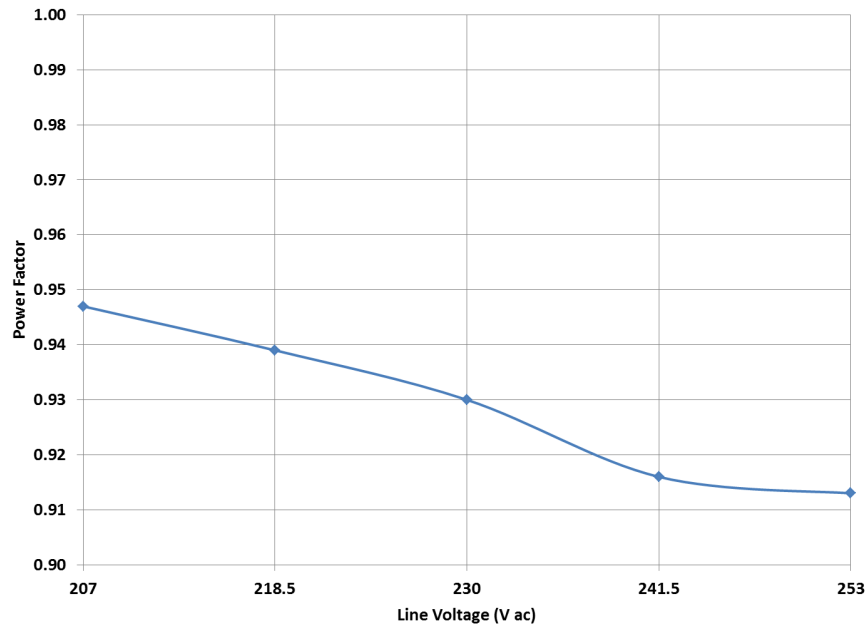

Figure 9. Power Factor Over Line

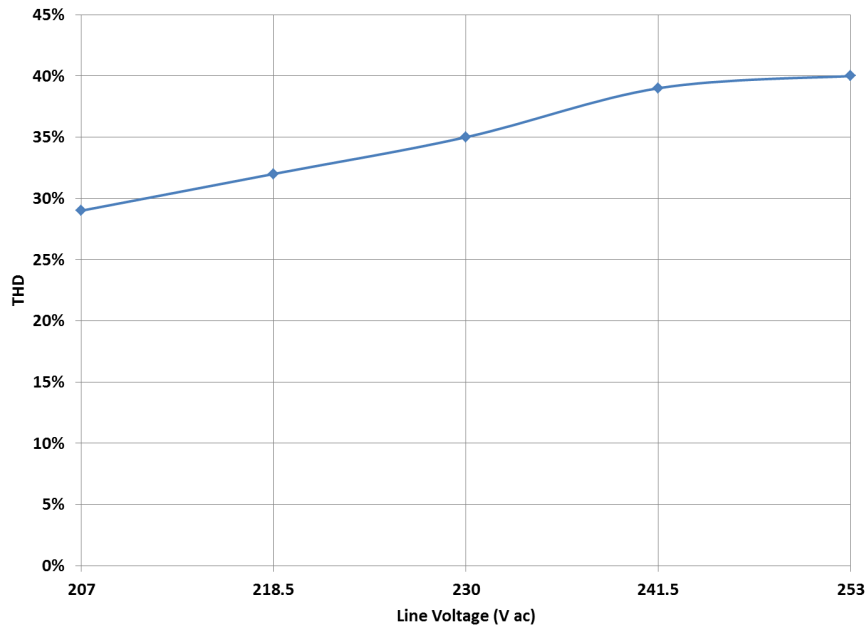

Figure 10. THD Over Line

NCL30073LED4GEVB

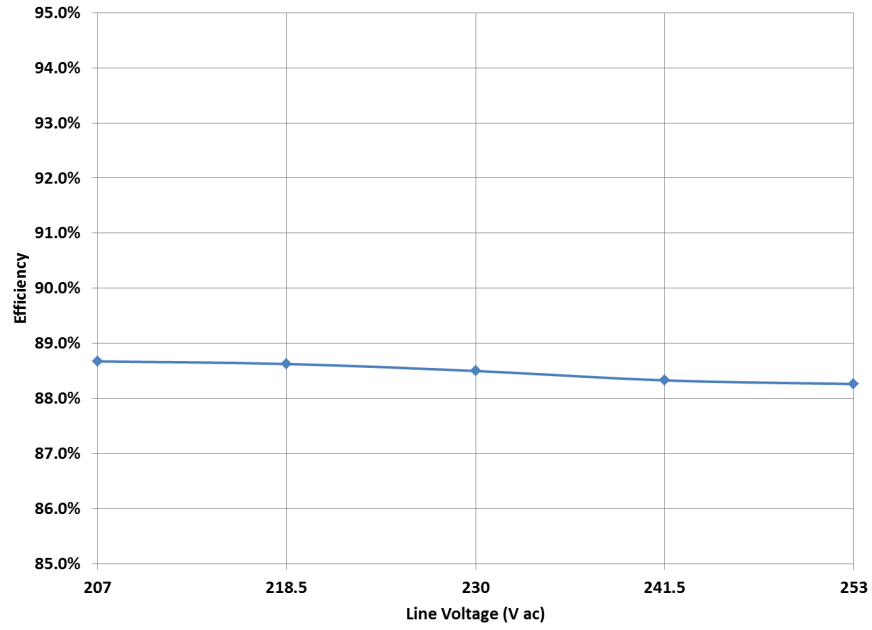

Figure 11. Efficiency

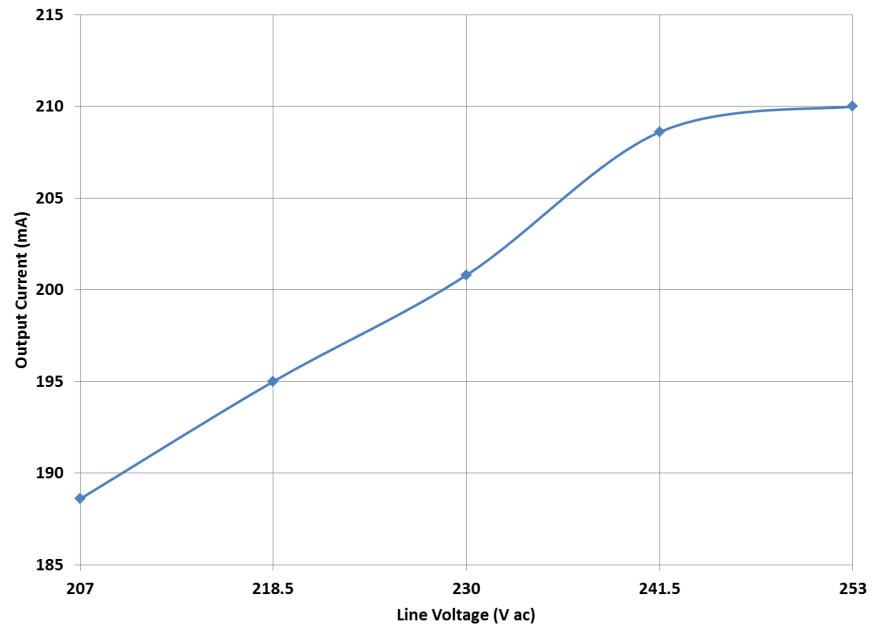

Figure 12. Regulation Over Line

NCL30073LED4GEVB

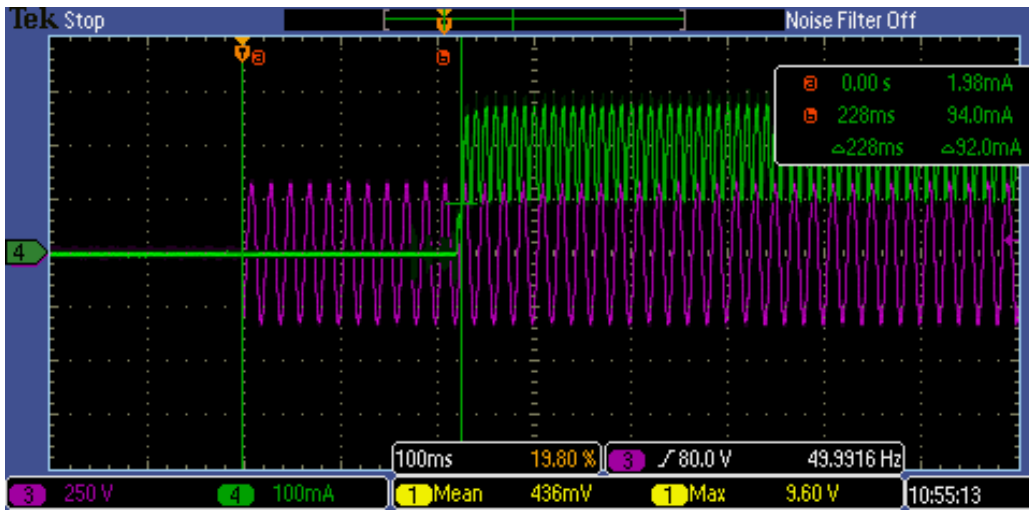

Figure 13. Start Up with AC Applied 230 V

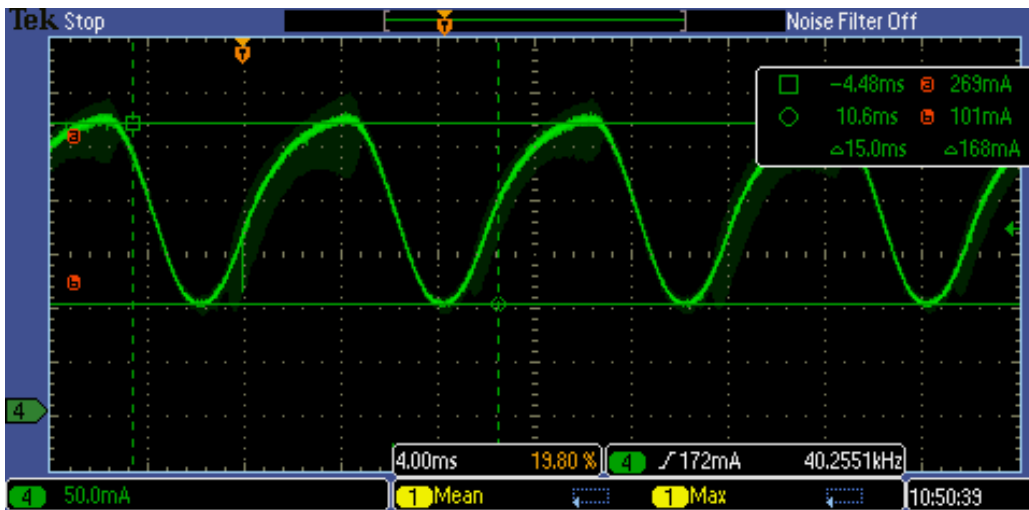

Figure 14. Output Ripple 75% Pk - Pk

NCL30073LED4GEVB

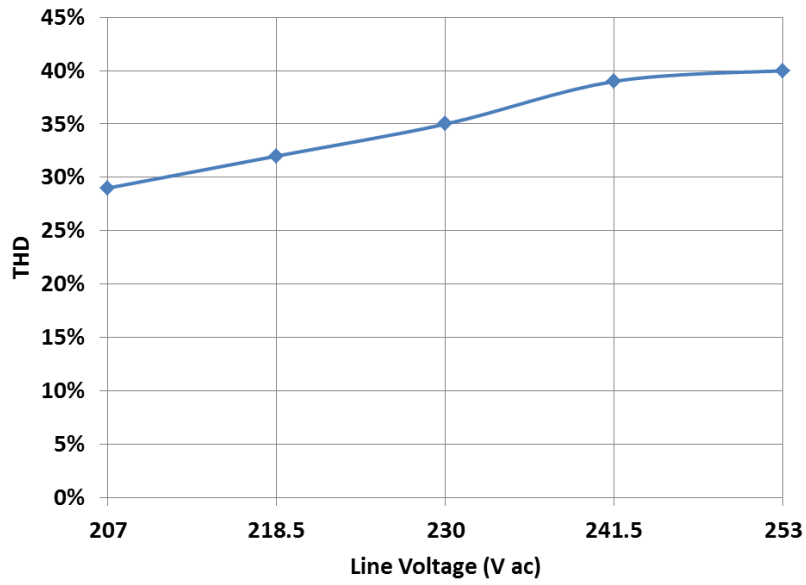

Figure 15.

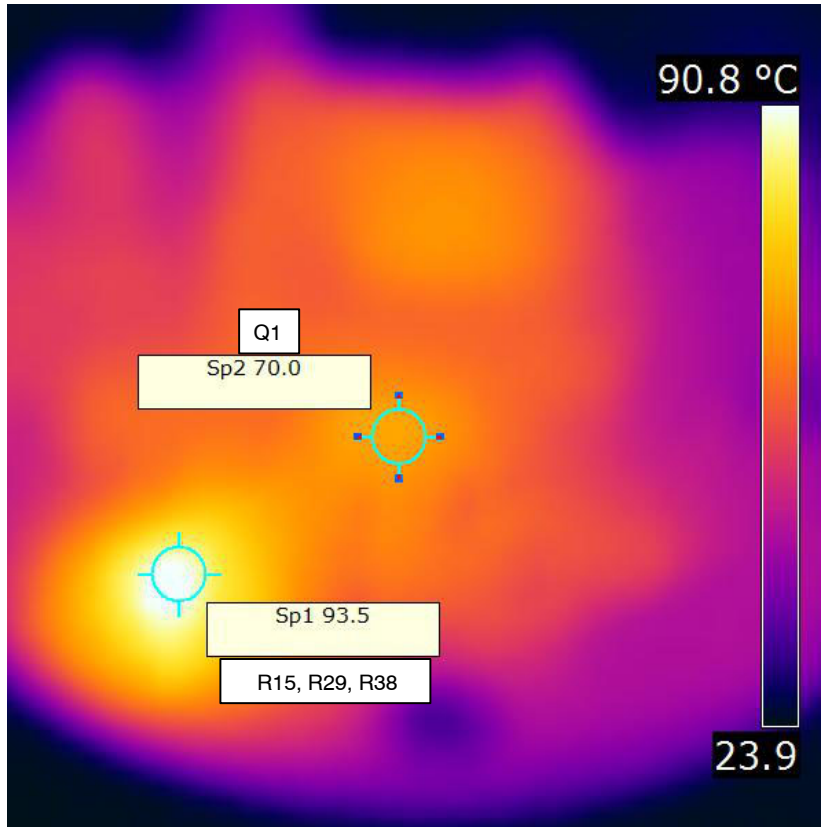

Figure 16. Thermal Image SMT Side

onsemi, **Onsemi**, and other names, marks, and brands are registered and/or common law trademarks of Semiconductor Components Industries, LLC dba "**onsemi**" or its affiliates and/or subsidiaries in the United States and/or other countries. **onsemi** owns the rights to a number of patents, trademarks, copyrights, trade secrets, and other intellectual property. A listing of **onsemi**'s product/patent coverage may be accessed at www.onsemi.com/site/pdf/Patent-Marking.pdf. **onsemi** is an Equal Opportunity/Affirmative Action Employer. This literature is subject to all applicable copyright laws and is not for resale in any manner.

The evaluation board/kit (research and development board/kit) (hereinafter the "board") is not a finished product and is not available for sale to consumers. The board is only intended for research, development, demonstration and evaluation purposes and will only be used in laboratory/development areas by persons with an engineering/technical training and familiar with the risks associated with handling electrical/mechanical components, systems and subsystems. This person assumes full responsibility/liability for proper and safe handling. Any other use, resale or redistribution for any other purpose is strictly prohibited.

THE BOARD IS PROVIDED BY ONSEMI TO YOU "AS IS" AND WITHOUT ANY REPRESENTATIONS OR WARRANTIES WHATSOEVER. WITHOUT LIMITING THE FOREGOING, ONSEMI (AND ITS LICENSORS/SUPPLIERS) HEREBY DISCLAIMS ANY AND ALL REPRESENTATIONS AND WARRANTIES IN RELATION TO THE BOARD, ANY MODIFICATIONS, OR THIS AGREEMENT, WHETHER EXPRESS, IMPLIED, STATUTORY OR OTHERWISE, INCLUDING WITHOUT LIMITATION ANY AND ALL REPRESENTATIONS AND WARRANTIES OF MERCHANTABILITY, FITNESS FOR A PARTICULAR PURPOSE, TITLE, NON-INFRINGEMENT, AND THOSE ARISING FROM A COURSE OF DEALING, TRADE USAGE, TRADE CUSTOM OR TRADE PRACTICE.

onsemi reserves the right to make changes without further notice to any board.

You are responsible for determining whether the board will be suitable for your intended use or application or will achieve your intended results. Prior to using or distributing any systems that have been evaluated, designed or tested using the board, you agree to test and validate your design to confirm the functionality for your application. Any technical, applications or design information or advice, quality characterization, reliability data or other services provided by **onsemi** shall not constitute any representation or warranty by **onsemi**, and no additional obligations or liabilities shall arise from **onsemi** having provided such information or services.

onsemi products including the boards are not designed, intended, or authorized for use in life support systems, or any FDA Class 3 medical devices or medical devices with a similar or equivalent classification in a foreign jurisdiction, or any devices intended for implantation in the human body. You agree to indemnify, defend and hold harmless **onsemi**, its directors, officers, employees, representatives, agents, subsidiaries, affiliates, distributors, and assigns, against any and all liabilities, losses, costs, damages, judgments, and expenses, arising out of any claim, demand, investigation, lawsuit, regulatory action or cause of action arising out of or associated with any unauthorized use, even if such claim alleges that **onsemi** was negligent regarding the design or manufacture of any products and/or the board.

This evaluation board/kit does not fall within the scope of the European Union directives regarding electromagnetic compatibility, restricted substances (RoHS), recycling (WEEE), FCC, CE or UL, and may not meet the technical requirements of these or other related directives.

FCC WARNING – This evaluation board/kit is intended for use for engineering development, demonstration, or evaluation purposes only and is not considered by **onsemi** to be a finished end product fit for general consumer use. It may generate, use, or radiate radio frequency energy and has not been tested for compliance with the limits of computing devices pursuant to part 15 of FCC rules, which are designed to provide reasonable protection against radio frequency interference. Operation of this equipment may cause interference with radio communications, in which case the user shall be responsible, at its expense, to take whatever measures may be required to correct this interference.

onsemi does not convey any license under its patent rights nor the rights of others.

LIMITATIONS OF LIABILITY: **onsemi** shall not be liable for any special, consequential, incidental, indirect or punitive damages, including, but not limited to the costs of requalification, delay, loss of profits or goodwill, arising out of or in connection with the board, even if **onsemi** is advised of the possibility of such damages. In no event shall **onsemi**'s aggregate liability from any obligation arising out of or in connection with the board, under any theory of liability, exceed the purchase price paid for the board, if any.

The board is provided to you subject to the license and other terms per **onsemi**'s standard terms and conditions of sale. For more information and documentation, please visit www.onsemi.com.

ADDITIONAL INFORMATION

TECHNICAL PUBLICATIONS:

Technical Library: www.onsemi.com/design/resources/technical-documentation
onsemi Website: www.onsemi.com

ONLINE SUPPORT: www.onsemi.com/support

For additional information, please contact your local Sales Representative at www.onsemi.com/support/sales