

Evaluating the **ADPD2140** IR Light Angle Sensor

FEATURES

ADPD2140 full configuration

- Register level

- Parameter level

Graph views

- Time series view

- Gesture recognition view

- Triangulation view

UDP transfer capability

EVALUATION KIT CONTENTS

EVAL-ADPD2140Z standard evaluation board

USB-C cable

ADDITIONAL EQUIPMENT NEEDED

EVAL-ADPDM3Z evaluation board

PC running Windows® 7 operating system

ONLINE RESOURCES

ADPD2140 data sheet

Applications Wavetool

GENERAL DESCRIPTION

The EVAL-ADPD2140Z evaluation kit allows users to interface with the **ADPD2140** infrared (IR) light angle sensor, collect data from the **ADPD2140**, and evaluate gesture recognition and triangulation capabilities.

The evaluation kit requires the **EVAL-ADPDM3Z** evaluation board and the **Applications Wavetool**, a graphical user interface (GUI) that provides users with low level and high level configurability, real-time data analysis, and user datagram protocol (UDP) transfer capability, which allows the **EVAL-ADPDM3Z** evaluation board to interface to a PC. The **Applications Wavetool** can be downloaded from the EVAL-ADPD2140Z evaluation board product page.

The USB port of the PC powers the **EVAL-ADPDM3Z** evaluation board and provides power to the EVAL-ADPD2140Z evaluation board. On-board voltage regulators provide voltage supplies for the **ADPD2140**.

The EVAL-ADPD2140Z evaluation board schematic indicates signal names for easy identification (see Figure 12).

Full specifications for the **ADPD2140** are available in the **ADPD2140** data sheet, which should be consulted in conjunction with this user guide when working with the EVAL-ADPD2140Z evaluation board.

EVALUATION BOARD PHOTOGRAPH

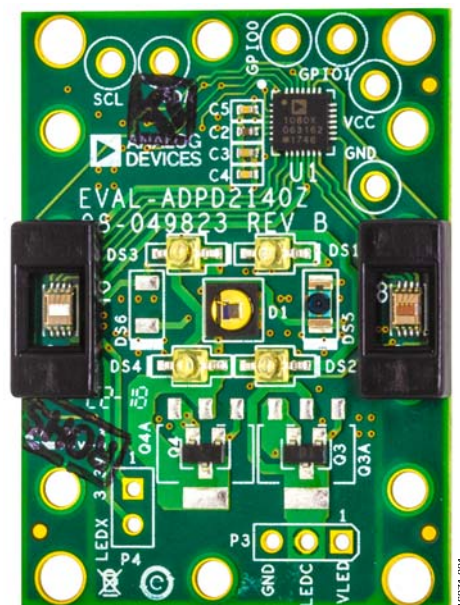

Figure 1.

TABLE OF CONTENTS

Features	1	EVAL-ADPD2140Z Evaluation Board USB Connection	3
Evaluation Kit Contents.....	1	Updating the EVAL-ADPDM3Z Evaluation Board Firmware	4
Additional Equipment Needed	1	Configuring the EVAL-ADPD2140Z Evaluation Kit	4
Online Resources	1	Streaming Data	4
General Description	1	Gesture Device.....	4
Evaluation Board Photograph.....	1	Angle Device	5
Revision History	2	Evaluation Board Schematics and Artwork.....	6
Evaluation Board Software Quick Start Procedures	3		
Installing the Applications Wavetool.....	3		

REVISION HISTORY

8/2018—Revision 0: Initial Version

EVALUATION BOARD SOFTWARE QUICK START PROCEDURES

INSTALLING THE APPLICATIONS WAVETOOL

Download the [Applications Wavetool](#) software package from the EVAL-ADPD2140Z evaluation board product page. Unzip the downloaded software folder, run the enclosed **Applications_Wavetool_1853.exe** file, and follow the prompts for installing the [Applications Wavetool](#) software (see Figure 2).

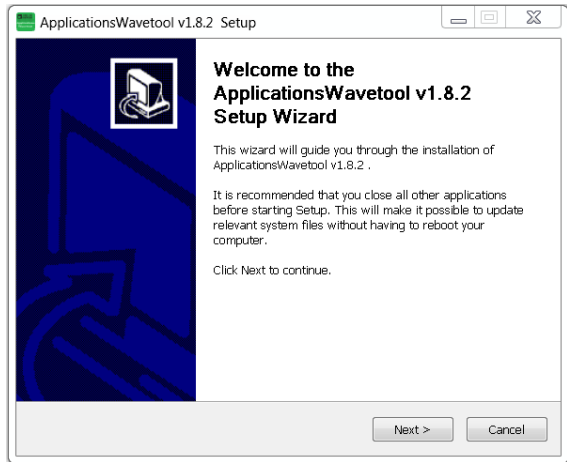

Figure 2. Applications Wavetool Setup

To start the [Applications Wavetool](#) application, navigate to the **ApplicationsWavetool** folder from the **Start** menu and click the **Applications Wavetool** icon (see Figure 3).

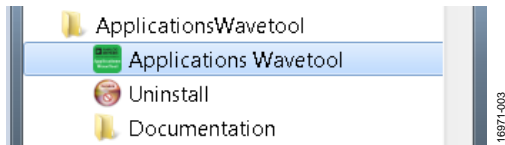

Figure 3. Navigate to the ApplicationsWavetool Folder from the Start Menu

At startup, the [Applications Wavetool](#) application automatically checks if the installed [Applications Wavetool](#) software version is up to date. If there is a newer version available, the user is prompted to download the newest version.

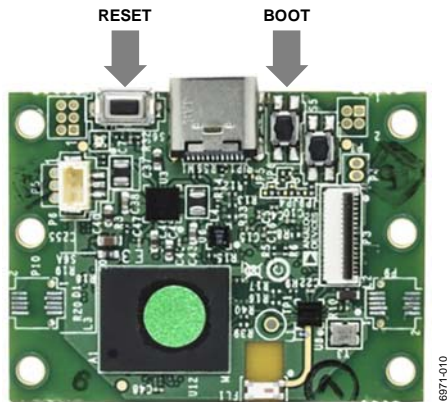

Figure 4. EVAL-ADPD3Z Evaluation Board

EVAL-ADPD2140Z EVALUATION BOARD USB CONNECTION

Prior to starting the [Applications Wavetool](#) application, connect the EVAL-ADPD2140Z evaluation board to the [EVAL-ADPDM3Z](#) evaluation board via the board to board connectors. Connect the [EVAL-ADPDM3Z](#) evaluation board to a PC via the USB-C cable included with the evaluation kit. The PC automatically finds the device drivers and installs them if they have not been previously installed. When the [EVAL-ADPDM3Z](#) evaluation board is connected, open the [Applications Wavetool](#) application (see Figure 5).

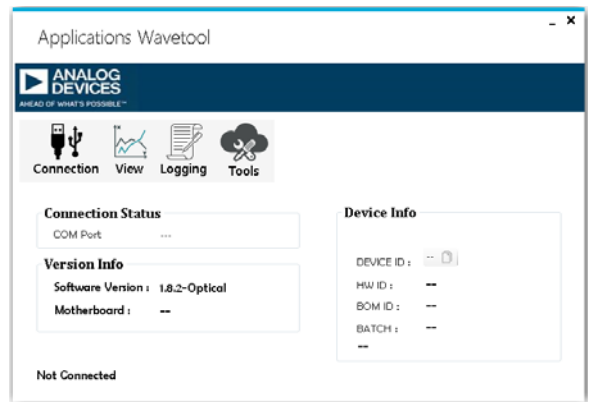

Figure 5. Applications Wavetool Window

After the [Applications Wavetool](#) application opens, click **Connection > Connect** to open the communication (COM) port selection window. Select the appropriate COM port from the **Connect** dropdown menu and click **Connect** (see Figure 6). The [Applications Wavetool](#) then acknowledges that the EVAL-ADPD2140Z evaluation board is connected by displaying **M3 Motherboard Found** on the screen.

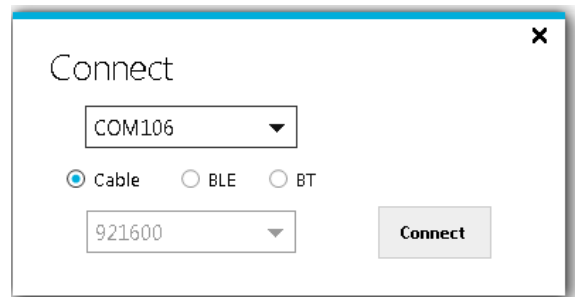

Figure 6. COM Port Selection Window

UPDATING THE EVAL-ADPDM3Z EVALUATION BOARD FIRMWARE

If the EVAL-ADPDM3Z evaluation board firmware is out of date, the software displays a warning, as shown in Figure 7. If this warning occurs, click **Tools > Firmware Update** from the main window, and click **Ok** in the dialog box. Follow the instructions shown in Figure 7 to update the EVAL-ADPDM3Z evaluation board firmware.

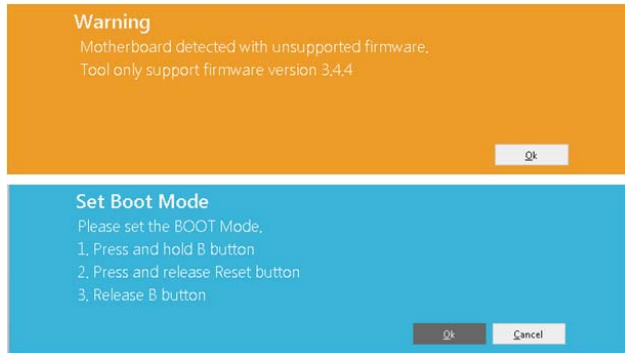

Figure 7. Updating the EVAL-ADPDM3Z Evaluation Board Firmware

CONFIGURING THE EVAL-ADPD2140Z EVALUATION KIT

To operate the EVAL-ADPD2140Z evaluation board in gesture detect mode, click **View > Gesture Device**. Click **ADPD Config** to enter the gesture configuration window. Click **Load DCFG**, select **ADPD1080Z-GST_Gesture.dcfg**, and click **Open** (see Figure 8).

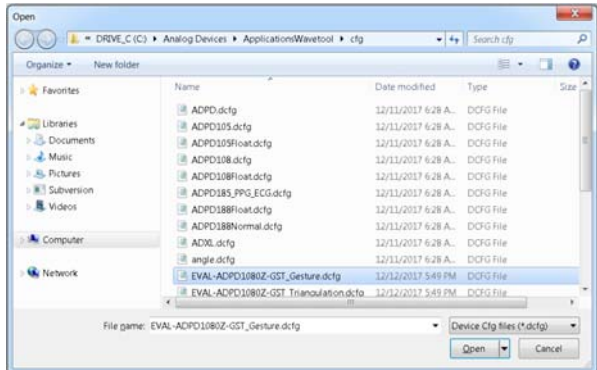

Figure 8. Loading the Configuration File

By default, this file configures the EVAL-ADPD2140Z evaluation board to use the LEDX1 light emitting diode (LED) driver, which is optimized for gesture recognition. After loading the configuration file, click **Power Calculation**, which opens a new window. Press M on the keyboard. In the new window, under **Boost Enable**, ensure that the **Boost Enable** check box is selected (see Figure 9). This control is automatically selected upon connecting the EVAL-ADPD2140Z evaluation board and the EVAL-ADPDM3Z evaluation board to the PC.

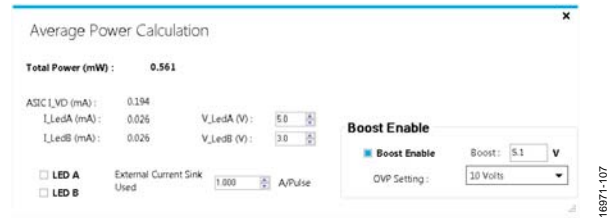

Figure 9. Boost Enable Selection

STREAMING DATA

Return to the **Gesture Device** window and click the **Play** icon to begin streaming data from the EVAL-ADPD2140Z evaluation board. Move an object or hand within 30 cm above the EVAL-ADPD2140Z evaluation board to see the corresponding output of the device on the graphs. The **Y Ratio vs X Ratio** graph shows the calculated x and y positions of the object above the device (see Figure 10). The **Raw Data** graph shows the four data output channels (x_R , x_L , y_T , and y_B) change as a function of reflected light seen by the device, represented in analog-to-digital converter (ADC) codes. In the **Y Ratio vs X Ratio** graph, an offset of 255 codes is applied to all four channels to prevent division by zero in the calculation of x and y. See the **ADPD2140** data sheet for more information.



Figure 10. Gesture Device Window

GESTURE DEVICE

To view the gesture recognition capability, remain in the **Gesture Device** window with data streaming turned on. Move a hand or other reflective object within 30 cm above the device and swipe in any of the four indicated directions. Alternatively, the center indicator can be activated by quickly lowering an object towards the sensor.

ANGLE DEVICE

To view the x and y response and triangulation data, stop data streaming by clicking the **Stop** icon. Exit the **Gesture Device** window and click **View > Angle Device** in the **Applications Wavetool** main application window. Click **ADPD Config** to open the configuration window. Click **Load DCFG** and select **ADPD1080Z-GST_Angle_nominal_01.dcfg** to load the triangulation settings.

Return to the **Angle Device** window. Click the **Play** icon to begin streaming data. Ensure that no objects are within 50 cm of the EVAL-ADPD2140Z evaluation board and then select the **Zero Offsets** check box.

Move a hand or other reflective object within 20 cm directly above the device. The **Y Ratio vs X Ratio** graph shows the x and y data without added offsets. On the right side, the **Log Intensity** field shows the log of the sum of the four channels. The **Distance (mm)** field shows the distance calculated through triangulation of the angles seen by the two **ADPD2140** devices on the EVAL-ADPD2140Z evaluation board (see Figure 10).

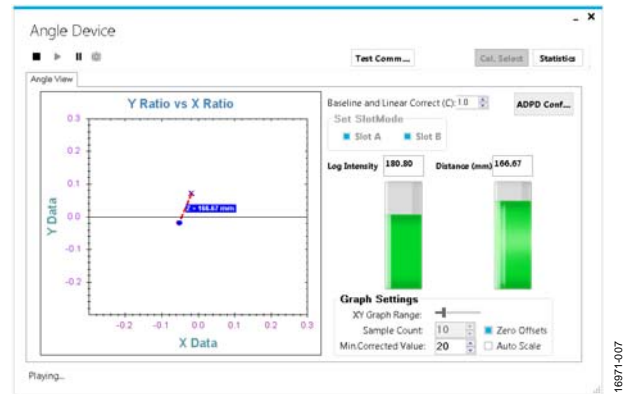

Figure 11. Angle Device Window

For more detailed information on the **Applications Wavetool** and additional features of the software, see the **Applications Wavetool** user manual, which can be found in the **Help > Help Topics** menu.

EVALUATION BOARD SCHEMATICS AND ARTWORK

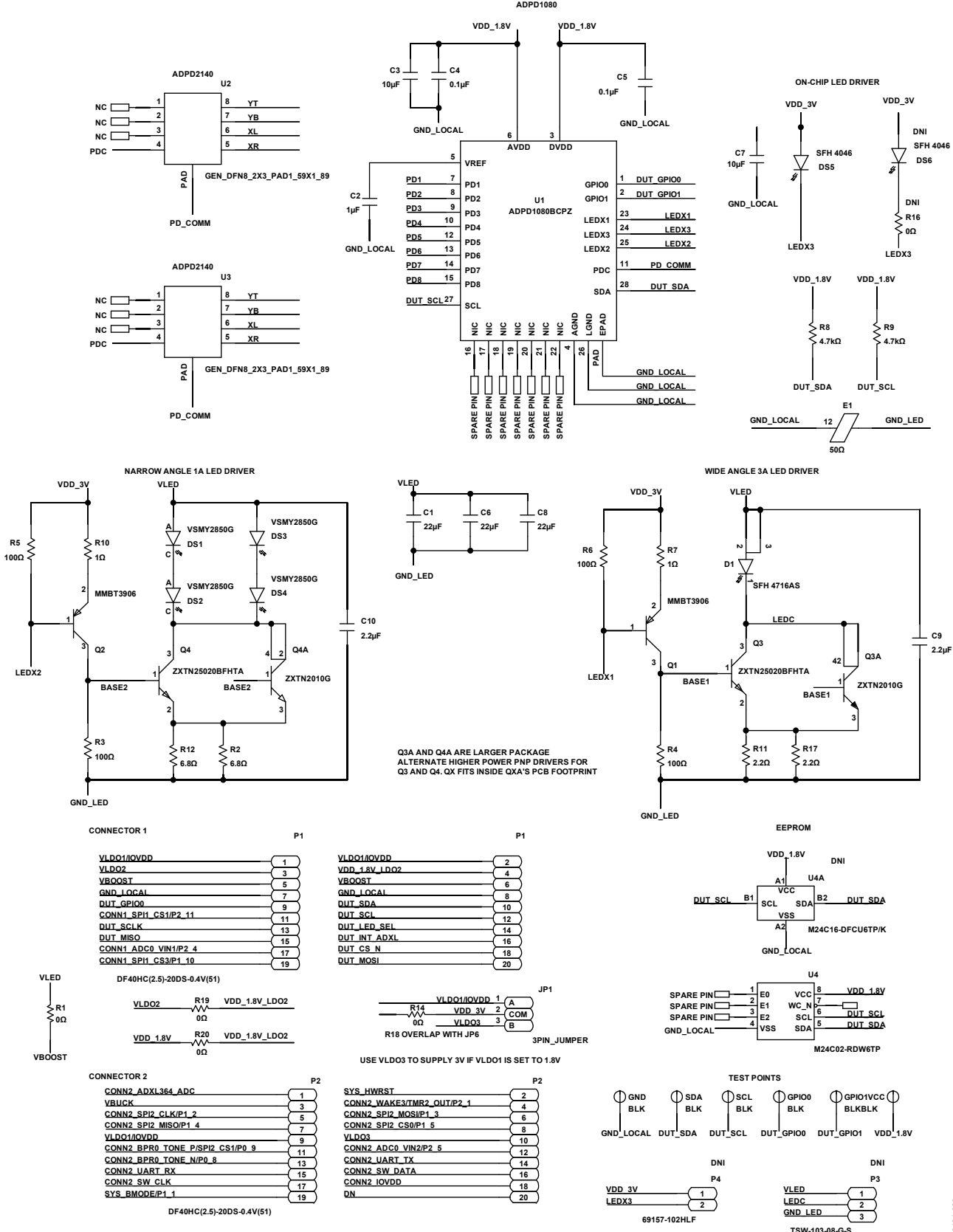

Figure 12. EVAL-ADPD2140Z Evaluation Board Schematic

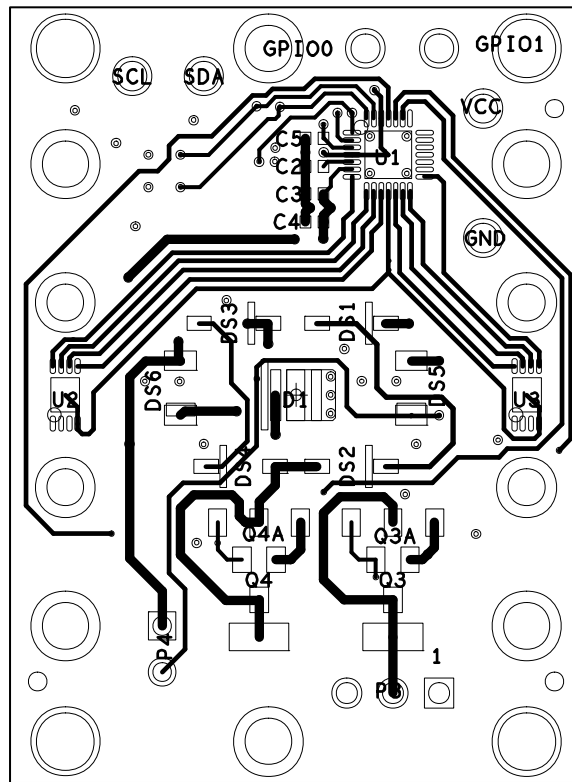

Figure 13. EVAL-ADPD2140Z Evaluation Board Layout



ESD Caution

ESD (electrostatic discharge) sensitive device. Charged devices and circuit boards can discharge without detection. Although this product features patented or proprietary protection circuitry, damage may occur on devices subjected to high energy ESD. Therefore, proper ESD precautions should be taken to avoid performance degradation or loss of functionality.

Legal Terms and Conditions

By using the evaluation board discussed herein (together with any tools, components documentation or support materials, the "Evaluation Board"), you are agreeing to be bound by the terms and conditions set forth below ("Agreement") unless you have purchased the Evaluation Board, in which case the Analog Devices Standard Terms and Conditions of Sale shall govern. Do not use the Evaluation Board until you have read and agreed to the Agreement. Your use of the Evaluation Board shall signify your acceptance of the Agreement. This Agreement is made by and between you ("Customer") and Analog Devices, Inc. ("ADI"), with its principal place of business at One Technology Way, Norwood, MA 02062, USA. Subject to the terms and conditions of the Agreement, ADI hereby grants to Customer a free, limited, personal, temporary, non-exclusive, non-sublicensable, non-transferable license to use the Evaluation Board FOR EVALUATION PURPOSES ONLY. Customer understands and agrees that the Evaluation Board is provided for the sole and exclusive purpose referenced above, and agrees not to use the Evaluation Board for any other purpose. Furthermore, the license granted is expressly made subject to the following additional limitations: Customer shall not (i) rent, lease, display, sell, transfer, assign, sublicense, or distribute the Evaluation Board; and (ii) permit any Third Party to access the Evaluation Board. As used herein, the term "Third Party" includes any entity other than ADI, Customer, their employees, affiliates and in-house consultants. The Evaluation Board is NOT sold to Customer; all rights not expressly granted herein, including ownership of the Evaluation Board, are reserved by ADI. CONFIDENTIALITY. This Agreement and the Evaluation Board shall all be considered the confidential and proprietary information of ADI. Customer may not disclose or transfer any portion of the Evaluation Board to any other party for any reason. Upon discontinuation of use of the Evaluation Board or termination of this Agreement, Customer agrees to promptly return the Evaluation Board to ADI. ADDITIONAL RESTRICTIONS. Customer may not disassemble, decompile or reverse engineer chips on the Evaluation Board. Customer agrees to return the Evaluation Board to ADI if any occurred damages or any modifications or alterations it makes to the Evaluation Board, including but not limited to soldering or any other activity that affects the material content of the Evaluation Board. Modifications to the Evaluation Board must comply with applicable law, including but not limited to the RoHS Directive. TERMINATION. ADI may terminate this Agreement at any time upon giving written notice to Customer. Customer agrees to return to ADI the Evaluation Board at that time. LIMITATION OF LIABILITY. THE EVALUATION BOARD PROVIDED HEREUNDER IS PROVIDED "AS IS" AND ADI MAKES NO WARRANTIES OR REPRESENTATIONS OF ANY KIND WITH RESPECT TO IT. ADI SPECIFICALLY DISCLAIMS ANY REPRESENTATIONS, ENDORSEMENTS, GUARANTEES, OR WARRANTIES, EXPRESS OR IMPLIED, RELATED TO THE EVALUATION BOARD INCLUDING, BUT NOT LIMITED TO, THE IMPLIED WARRANTY OF MERCHANTABILITY, TITLE, FITNESS FOR A PARTICULAR PURPOSE OR NON-INFRINGEMENT OF INTELLECTUAL PROPERTY RIGHTS. IN NO EVENT WILL ADI AND ITS LICENSORS BE LIABLE FOR ANY INCIDENTAL, SPECIAL, INDIRECT, OR CONSEQUENTIAL DAMAGES RESULTING FROM CUSTOMER'S POSSESSION OR USE OF THE EVALUATION BOARD, INCLUDING BUT NOT LIMITED TO LOST PROFITS, DELAY COSTS, LABOR COSTS OR LOSS OF GOODWILL. ADI'S TOTAL LIABILITY FROM ANY AND ALL CAUSES SHALL BE LIMITED TO THE AMOUNT OF ONE HUNDRED US DOLLARS (\$100.00). EXPORT. Customer agrees that it will not directly or indirectly export the Evaluation Board to another country, and that it will comply with all applicable United States federal laws and regulations relating to exports. GOVERNING LAW. This Agreement shall be governed by and construed in accordance with the substantive laws of the Commonwealth of Massachusetts (excluding conflict of law rules). Any legal action regarding this Agreement will be heard in the state or federal courts having jurisdiction in Suffolk County, Massachusetts, and Customer hereby submits to the personal jurisdiction and venue of such courts. The United Nations Convention on Contracts for the International Sale of Goods shall not apply to this Agreement and is expressly disclaimed.

©2018 Analog Devices, Inc. All rights reserved. Trademarks and registered trademarks are the property of their respective owners. UG16971-0-8/18(0)



www.analog.com