

## SUMMARY

### # Wires

Triax 1



*Image is for illustrative purpose only*

Series 0S  
Termination type Male solder  
IP rating 50  
AWG wire size 0.00 - 0.00  
Cable Ø 0.00 - 0.00 mm  
Status Active  
Matching parts [FFA.0S.650.CTLC32Z](#)

### Download

[Request a quote](#)

[Catalog](#)

## TECHNICAL DETAILS

### Mechanics

Shell Style/Model ERA\*: Fixed receptacle, nut fixing  
Keying Circular, male  
Housing Material Brass (chrome plated [SAE AMS 2460]) shell and collet nut, nickel plated [SAE AMS QQ N 290] brass latch sleeve and mid pieces  
Weight 4.84 g

### Performance

Configuration 0S.650 : 1 Triax (50 Ohm)  
Insulator T: PTFE  
Rated Current 6 Amps

### Specifications

Contact Type: Triaxial 50 Ohm (Solder)  
Contact Dia.: 0.9 mm (0.035" in)  
Vtest: 1200 V (AC), 1700 V (DC)  
Impedance: 50 Ohm  
VSWR: 1.03 + 0.34 \* f/GHz  
Cable type: RGT 178, RGT 174

### Others

*LEMO products and services are provided "as is". LEMO makes no warranties or representations with regard to LEMO product & services or use of them, express, implied or statutory, including for accuracy, completeness, or security. The user is fully responsible for his products and applications using LEMO components.*

Endurance (Shell): 5000 mating cycles  
 Temp (min / max): -55°C / +250°C  
 Humidity (max): <=95% [at 60 deg C / 140 F]  
 Vibration: 15 g [10 Hz - 2000 Hz]  
 Shock Resistance: 100 g [ 6 ms]  
 Climatical Category: 50/175/21  
 Shielding (min): 75 dB (10 MHz)  
 Shielding (min): 40 dB (1 GHz)  
 Salt Spray Corrosion: >1000 hr

## DRAWINGS

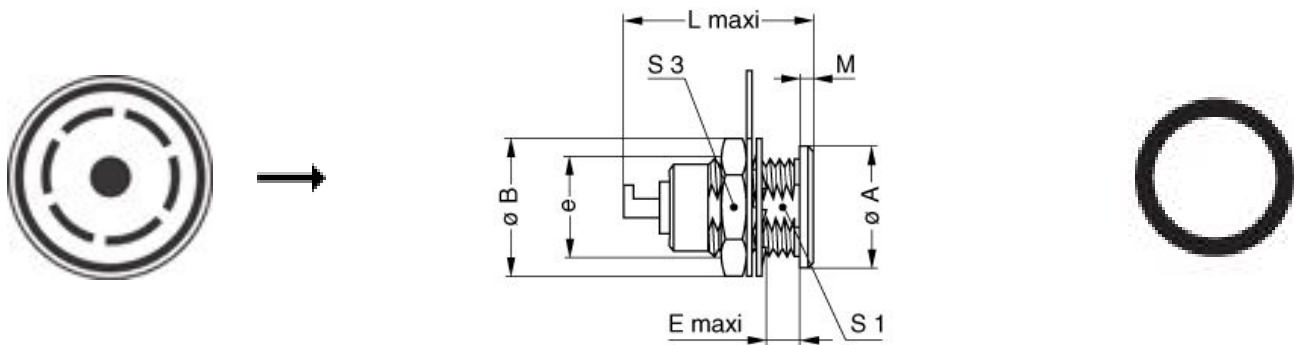

### Dimensions

	A	B	E	L	M	S1	S3	e
mm.	10	12.5	7	18.5	1.2	8.2	11	M9x0.6
in.	0,39	0,49	0,28	0,73	0,05	0,32	0,43	

## RECOMMENDED BY LEMO

### Tools

Spanner wrench: [Socket for torque wrench DCM.05.M09.4](#)

*LEMO products and services are provided "as is". LEMO makes no warranties or representations with regard to LEMO product & services or use of them, express, implied or statutory, including for accuracy, completeness, or security. The user is fully responsible for his products and applications using LEMO components.*

*LEMO products and services are provided "as is". LEMO makes no warranties or representations with regard to LEMO product & services or use of them, express, implied or statutory, including for accuracy, completeness, or security. The user is fully responsible for his products and applications using LEMO components.*