

## EPC2044 – Enhancement Mode Power Transistor

 $V_{DS}$ , 100 V $R_{DS(on)}$ , 10.5 m $\Omega$  $I_D$ , 9.4 A

Gallium Nitride's exceptionally high electron mobility and low temperature coefficient allows very low  $R_{DS(on)}$ , while its lateral device structure and majority carrier diode provide exceptionally low  $Q_G$  and zero  $Q_{RR}$ . The end result is a device that can handle tasks where very high switching frequency, and low on-time are beneficial as well as those where on-state losses dominate.

## Maximum Ratings

PARAMETER		VALUE	UNIT
$V_{DS}$	Drain-to-Source Voltage (Continuous)	100	V
	Drain-to-Source Voltage (up to 10,000 5 ms pulses at 150°C)	120	
$I_D$	Continuous ( $T_A = 25^\circ\text{C}$ )	9.4	A
	Pulsed (25°C, $T_{PULSE} = 300 \mu\text{s}$ )	89	
$V_{GS}$	Gate-to-Source Voltage	6	V
	Gate-to-Source Voltage	-4	
$T_J$	Operating Temperature	-40 to 150	°C
$T_{STG}$	Storage Temperature	-40 to 150	

## Thermal Characteristics

PARAMETER		TYP	UNIT
$R_{\theta JC}$	Thermal Resistance, Junction-to-Case	1.3	°C/W
$R_{\theta JB}$	Thermal Resistance, Junction-to-Board	4.1	
$R_{\theta JA}$	Thermal Resistance, Junction-to-Ambient (Note 1)	72	

Note 1:  $R_{\theta JA}$  is determined with the device mounted on one square inch of copper pad, single layer 2 oz copper on FR4 board. See [https://epc-co.com/epc/documents/product-training/Appnote\\_Thermal\\_Performance\\_of\\_eGaN\\_FETs.pdf](https://epc-co.com/epc/documents/product-training/Appnote_Thermal_Performance_of_eGaN_FETs.pdf) for details.

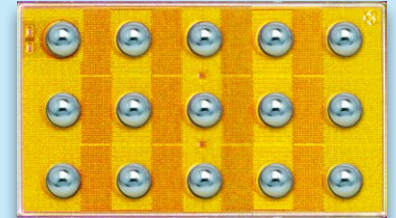

**EPC2044** eGaN® FETs are supplied only in passivated die form with copper pillars. Die size: 2.15 x 1.25 mm

## Applications

- 48 V Servers
- Lidar/Pulsed Power
- Isolated Power Supplies
- Point of Load Converters
- Class D Audio
- LED Lighting
- Low Inductance Motor Drive



## Benefits

- Higher Switching Frequency – Lower switching losses and lower drive power
- Higher Efficiency – Lower conduction and switching losses, zero reverse recovery losses
- Ultra Small Footprint - Higher power density

Static Characteristics ( $T_J = 25^\circ\text{C}$  unless otherwise stated)

PARAMETER		TEST CONDITIONS	MIN	TYP	MAX	UNIT
$BV_{DSS}$	Drain-to-Source Voltage	$V_{GS} = 0 \text{ V}, I_D = 0.2 \text{ mA}$	100			V
$I_{DSS}$	Drain-Source Leakage	$V_{GS} = 0 \text{ V}, V_{DS} = 80 \text{ V}$		0.03	0.17	mA
$I_{GSS}$	Gate-to-Source Forward Leakage	$V_{GS} = 5 \text{ V}$		0.01	0.17	
	Gate-to-Source Forward Leakage <sup>#</sup>	$V_{GS} = 5 \text{ V}, T_J = 125^\circ\text{C}$		0.07	3.4	
$I_{GSS}$	Gate-to-Source Reverse Leakage	$V_{GS} = -4 \text{ V}$		0.03	0.33	
$V_{GS(TH)}$	Gate Threshold Voltage	$V_{DS} = V_{GS}, I_D = 3 \text{ mA}$	0.8	1.4	2.5	V
$R_{DS(on)}$	Drain-Source On Resistance	$V_{GS} = 5 \text{ V}, I_D = 10 \text{ A}$		7	10.5	m $\Omega$
$V_{SD}$	Source-Drain Forward Voltage <sup>#</sup>	$I_S = 0.5 \text{ A}, V_{GS} = 0 \text{ V}$		2.0		V

<sup>#</sup> Defined by design. Not subject to production test.

Dynamic Characteristics# (T<sub>J</sub> = 25°C unless otherwise stated)

PARAMETER		TEST CONDITIONS	MIN	TYP	MAX	UNIT
C <sub>ISS</sub>	Input Capacitance	V <sub>DS</sub> = 50 V, V <sub>GS</sub> = 0 V		503	664	pF
C <sub>RSS</sub>	Reverse Transfer Capacitance			1.8		
C <sub>OSS</sub>	Output Capacitance			196	294	
C <sub>OSS(ER)</sub>	Effective Output Capacitance, Energy Related (Note 2)	V <sub>DS</sub> = 0 to 50 V, V <sub>GS</sub> = 0 V		247		pF
C <sub>OSS(TR)</sub>	Effective Output Capacitance, Energy Related (Note 3)			318		
R <sub>G</sub>	Gate Resistance			0.5		Ω
Q <sub>G</sub>	Total Gate Charge	V <sub>DS</sub> = 50 V, V <sub>GS</sub> = 5 V, I <sub>D</sub> = 10 A		4.3	5.5	nC
Q <sub>GS</sub>	Gate-to-Source Charge	V <sub>DS</sub> = 50 V, I <sub>D</sub> = 10 A		1.3		
Q <sub>GD</sub>	Gate-to-Drain Charge			0.5		
Q <sub>G(TH)</sub>	Gate Charge at Threshold			1.0		
Q <sub>OSS</sub>	Output Charge	V <sub>DS</sub> = 50 V, V <sub>GS</sub> = 0 V		15	23	
Q <sub>RR</sub>	Source-Drain Recovery Charge			0		

All measurements were done with substrate connected to source.

# Defined by design. Not subject to production test.

Note 2: C<sub>OSS(ER)</sub> is a fixed energy that gives the same stored energy as C<sub>OSS</sub> while V<sub>DS</sub> is rising from 0 to 50% BV<sub>DSS</sub>.

Note 3: C<sub>OSS(TR)</sub> is a fixed capacitance that gives the same charging time as C<sub>OSS</sub> while V<sub>DS</sub> is rising from 0 to 50% BV<sub>DSS</sub>.

Figure 1: Typical Output Characteristics at 25 °C

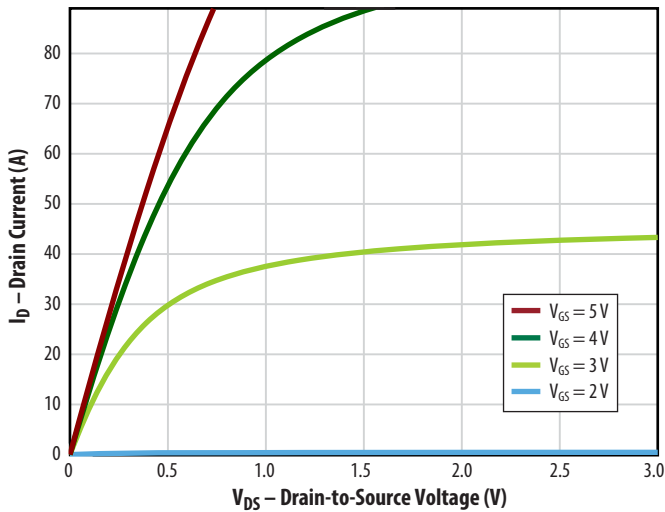

Figure 2: Typical Transfer Characteristics

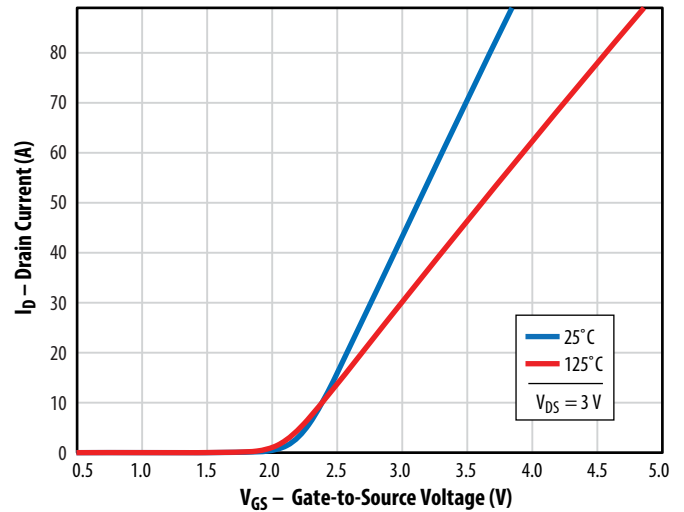

Figure 3: R<sub>DS(on)</sub> vs. V<sub>GS</sub> for Various Drain Currents

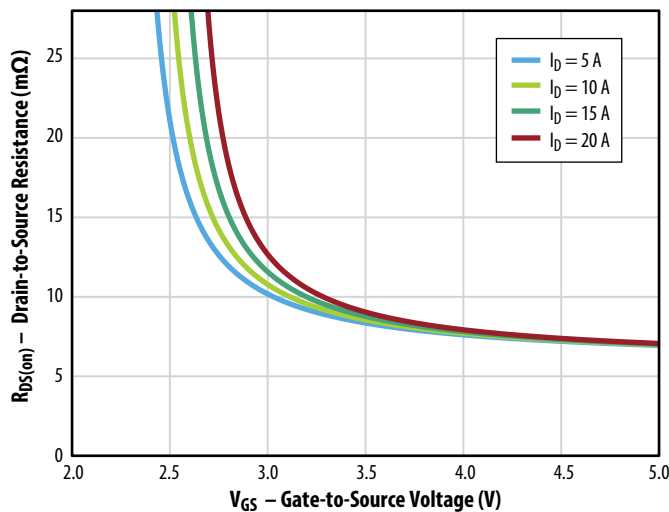

Figure 4: R<sub>DS(on)</sub> vs. V<sub>GS</sub> for Various Temperatures

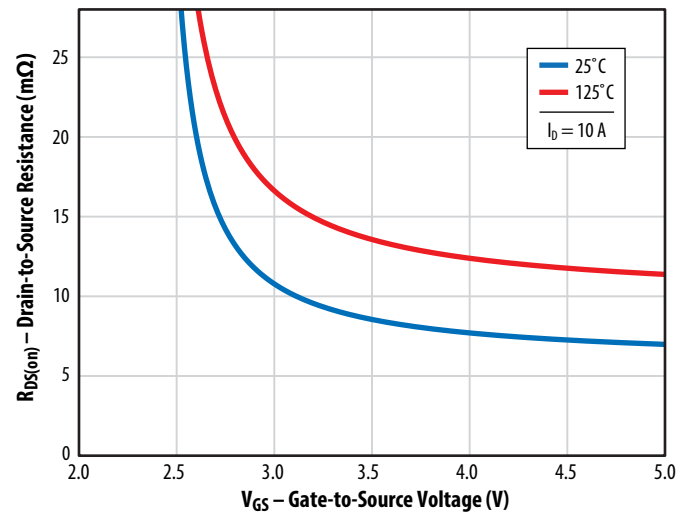

Figure 5a: Typical Capacitance (Linear Scale)

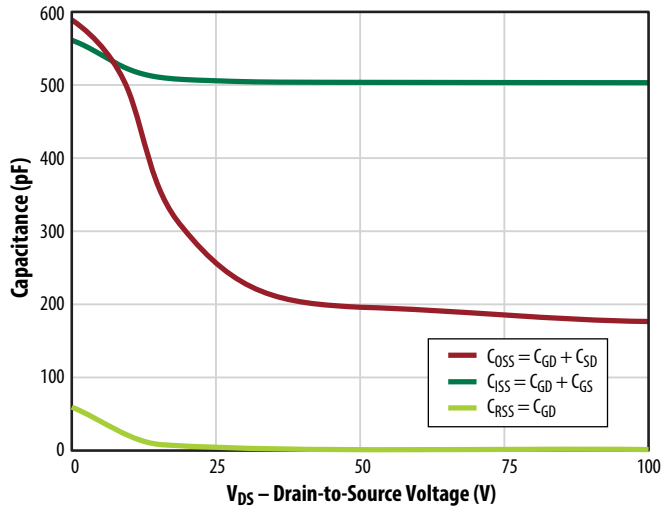

Figure 5b: Typical Capacitance (Log Scale)

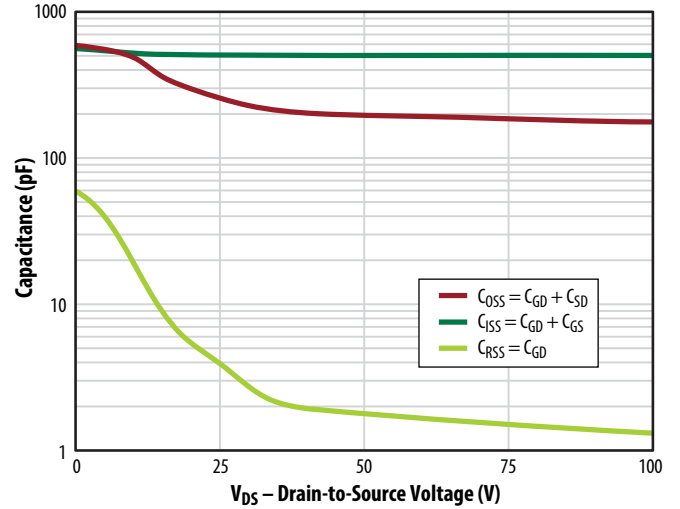

Figure 6: Typical Output Charge and C\_OSS Stored Energy

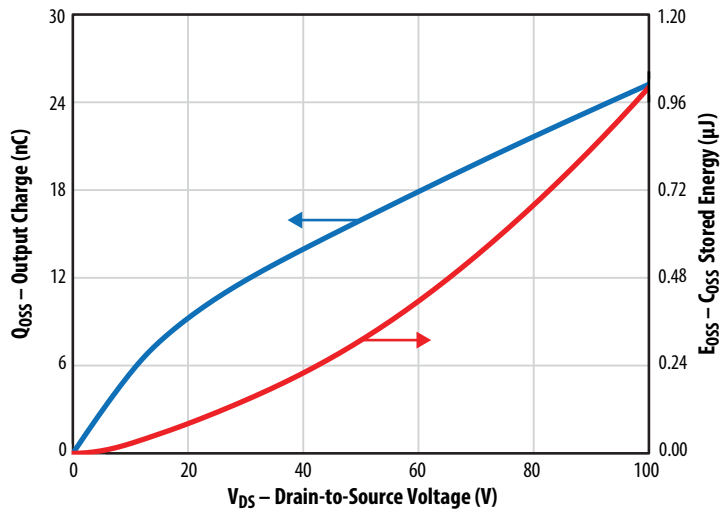

Figure 7: Typical Gate Charge

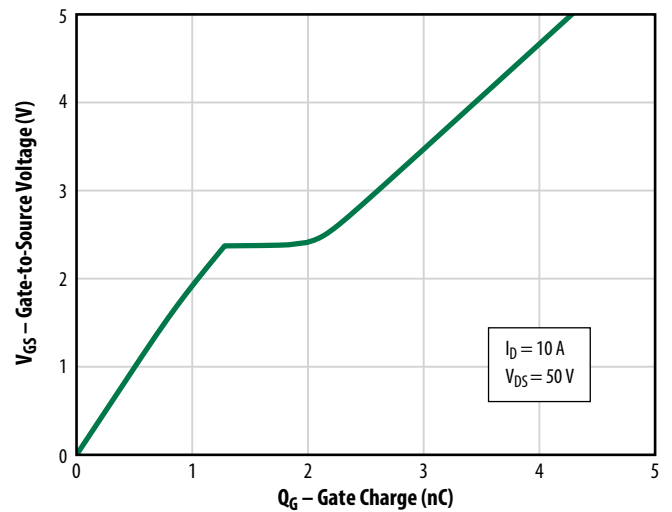

Figure 8: Reverse Drain-Source Characteristics

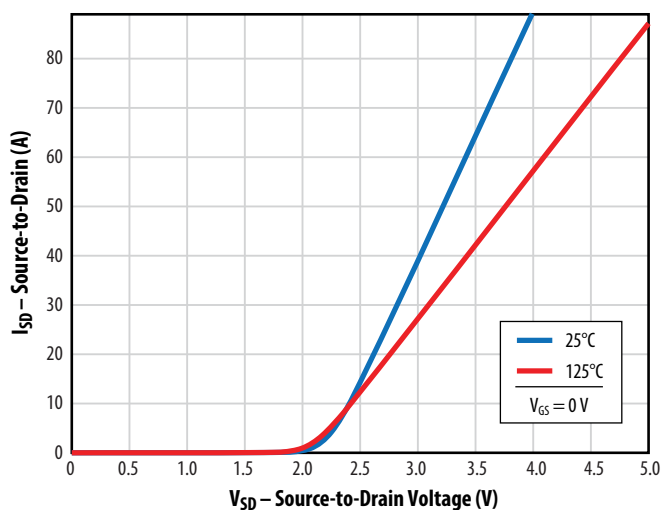
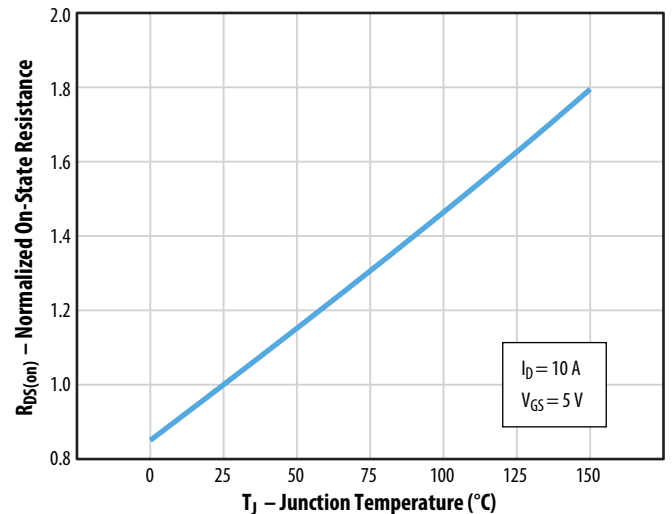

Figure 9: Normalized On-State Resistance vs. Temperature



Note: Negative gate drive voltage increases the reverse drain-source voltage. EPC recommends 0V for OFF.

Figure 10: Normalized Threshold Voltage vs. Temperature

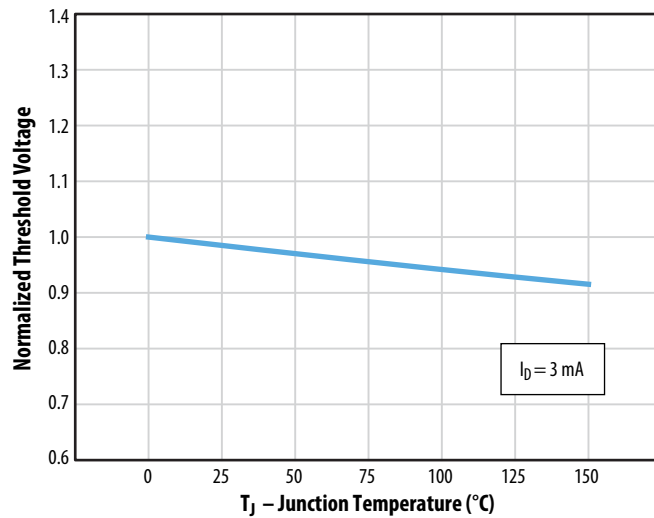

Figure 11: Transient Thermal Response Curves

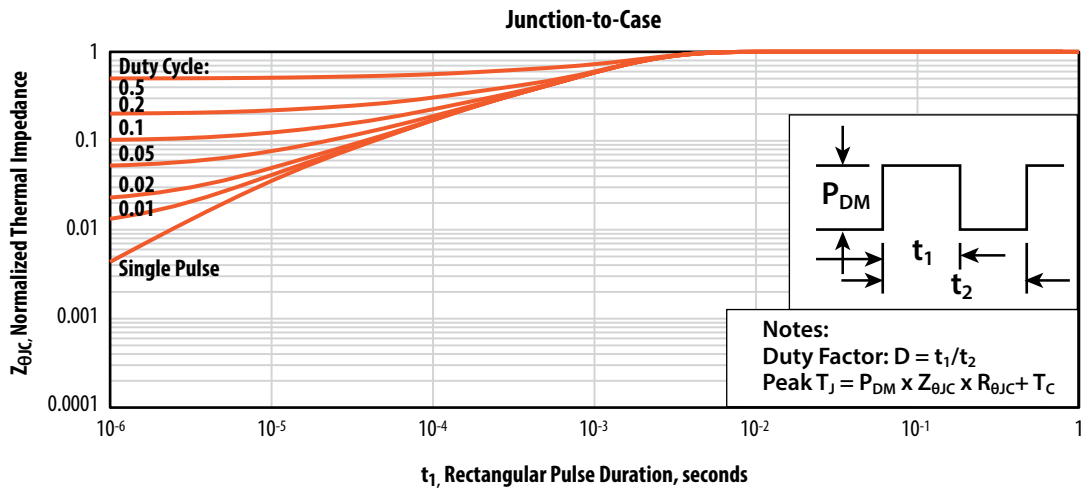
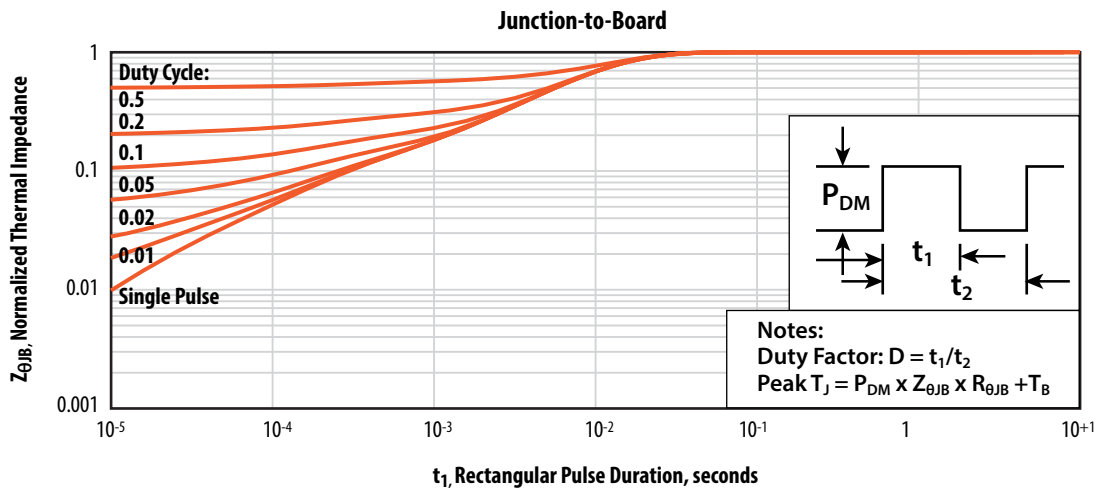
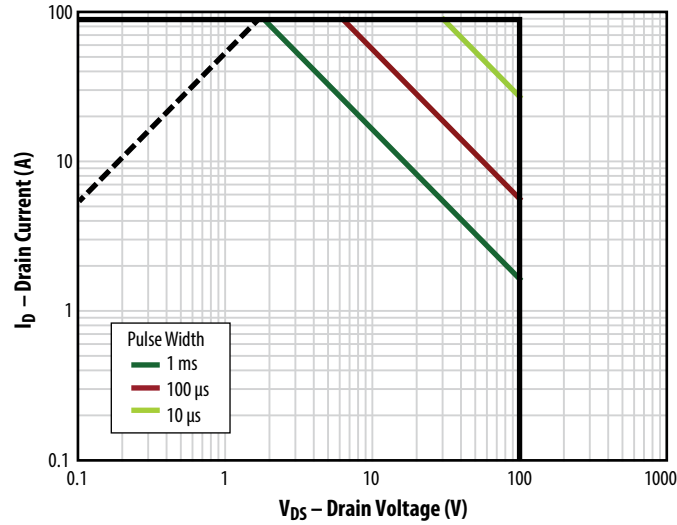
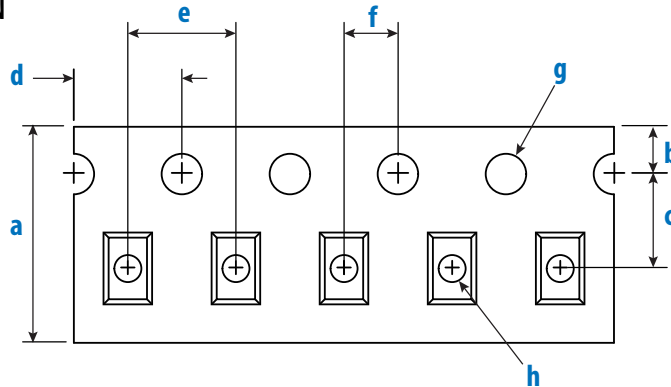
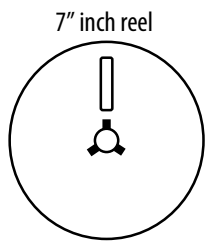

Figure 12: Safe Operating Area



TAPE AND REEL CONFIGURATION

4 mm pitch, 8 mm wide tape on 7" reel



Loaded Tape Feed Direction →

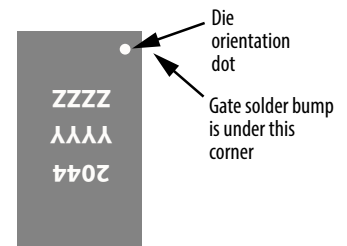

Die is placed into pocket solder bump side down (face side down)

EPC2044 (Note 1)	Dimension (mm)		
	Target	MIN	MAX
a	8.00	7.90	8.30
b	1.75	1.65	1.85
c (Note 2)	3.50	3.45	3.55
d	4.00	3.90	4.10
e	4.00	3.90	4.10
f (Note 2)	2.00	1.95	2.05
g	1.50	1.50	1.60

Note 1: MSL 1 (moisture sensitivity level 1) classified according to IPC/JEDEC industry standard.

Note 2: Pocket position is relative to the sprocket hole measured as true position of the pocket, not the pocket hole.

DIE MARKINGS

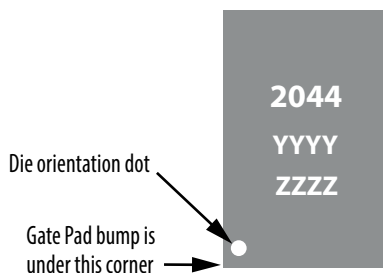

Part Number	Laser Markings		
	Part # Marking Line 1	Lot_Date Code Marking Line 2	Lot_Date Code Marking Line 3
EPC2044	2044	YYYY	ZZZZ

**DIE OUTLINE**

Solder Bar View

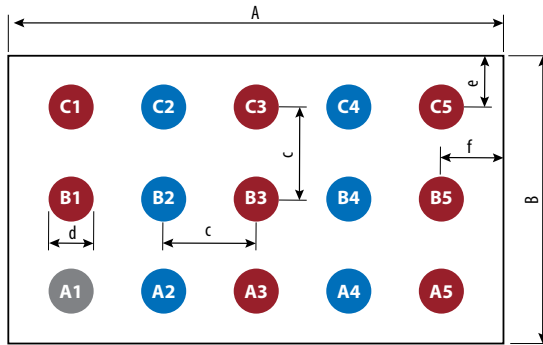

DIM	MICROMETERS		
	MIN	Nominal	MAX
A	2120	2150	2180
B	1220	1250	1280
c		400	
d		200	
e		225	
f		275	

Pad A1 is Gate;

Pads B1, C1, A3, B3, C3, A5, B5, C5 are Source;

Pads A2, B2, C2, A4, B4, C4 are Drain.

Side View

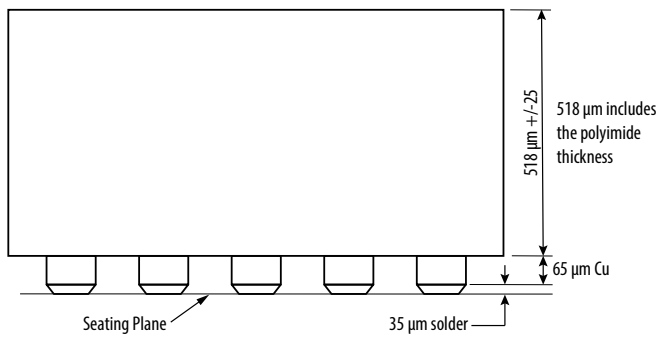

**RECOMMENDED LAND PATTERN**  
(measurements in µm)

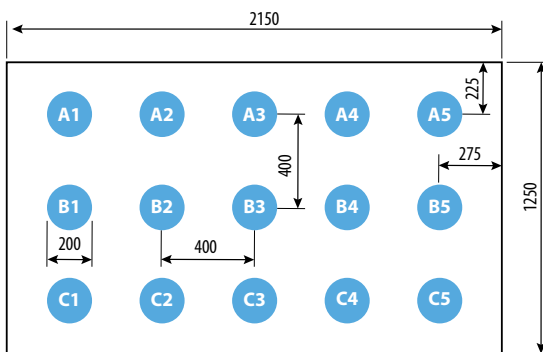

The land pattern is solder mask defined

Pad A1 is Gate;

Pads B1, C1, A3, B3, C3, A5, B5, C5 are Source;

Pads A2, B2, C2, A4, B4, C4 are Drain.

**RECOMMENDED STENCIL DRAWING**  
(units in µm)

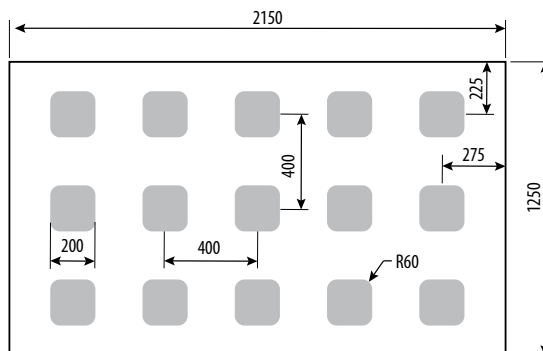

Recommended stencil should be 4 mil (100 µm) thick, must be laser cut, opening per drawing. The corner has a radius of R60.

Intended for use with SAC305 Type 4 solder, reference 88.5% metals content.

Additional assembly resources available at <https://www.epc-co.com/epc/DesignSupport/AssemblyBasics.aspx>

**Note:** Cu pillar dies are not intended for mounting on a PCB, they are intended for use in a package. Terms of die usage: The die represented by this data sheet are intended for initial evaluation for integration to buyer defined package. EPC does not guarantee reliability in the buyer specific package. To ensure reliability, the die may need redesign to be optimized to buyers specific package. NRE may apply.

Efficient Power Conversion Corporation (EPC) reserves the right to make changes without further notice to any products herein to improve reliability, function or design. EPC does not assume any liability arising out of the application or use of any product or circuit described herein; neither does it convey any license under its patent rights, nor the rights of others. eGaN® is a registered trademark of Efficient Power Conversion Corporation. EPC Patent Listing: [epc-co.com/epc/AboutEPC/Patents.aspx](http://epc-co.com/epc/AboutEPC/Patents.aspx)

Information subject to change without notice. Revised December, 2022