

Reference Only

Spec No. JENF243J-0017-01

P1/9

CHIP NOISE FILTER NFZ15SR□□□SN10D REFERENCE SPECIFICATION

1. Scope

This reference specification applies to Chip Noise Filter NFZ15SR_SN series.

2. Part Numbering

(ex)	NF	Z	15	SR	152	S	N	1	0	D
	Product ID	Structure	Dimension (L×W)	Characteristics	Typical Impedance at 900 MHz	Performance	Category	Numbers of Circuit	Special Speci-fication 0: Standard	Packaging D:Taping *B:Bulk

*Bulk packing also available. (A product is put in the plastic bag under the taping conditions.)

3. Rating

- Operating Temperature Range −40°C ~ +85°C
- Storage Temperature Range. −40°C ~ +85°C

Customer Part Number	MURATA Part Number	Impedance(Ω)			DC Resistance (Ω)		Rated Current (mA)
		at 100MHz	at 900MHz		Typ.	Max.	
		Typ.	Typ.	Min.			
	NFZ15SR152SN10D	200	1500	1000	0.55	0.7	400
	NFZ15SR262SN10D	400	2600	1750	1.00	1.2	300
	NFZ15SR352SN10D	500	3500	2500	1.30	1.65	270

4. Testing Conditions

《Unless otherwise specified》

Temperature : Ordinary Temperature / 15°C to 35°C
 Humidity : Ordinary Humidity / 25%(RH) to 85%(RH)

《In case of doubt》

Temperature : 20°C±2°C
 Humidity : 60%(RH) to 70%(RH)
 Atmospheric Pressure : 86kPa to 106 kPa

5. Appearance and Dimensions

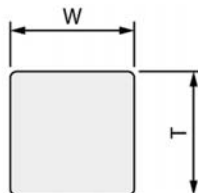
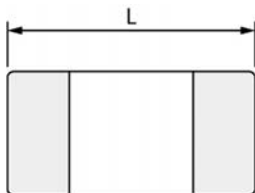

L	1.0±0.05
W	0.5±0.05
T	0.5±0.05
e	0.25±0.1

□ : Electrode
(in mm)

■ Equivalent Circuit



(Resistance element becomes dominant at high frequencies.)

■ Unit Mass (Typical value)
0.001g

6. Marking

No marking.

Reference Only

Spec No. JENF243J-0017-01

P2/9

7. Electrical Performance

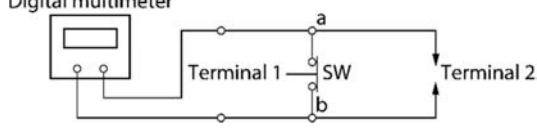
No.	Item	Specification	Test Method
7.1	Impedance	Impedance shall meet item 3.	Measuring Equipment: KEYSIGHT 4991A or equivalent (50mV) Measuring Frequency: 100 MHz / 900MHz
7.2	DC Resistance	DC Resistance shall meet item 3.	Measuring Equipment: Digital multi meter TR6846 or equivalent  DC resistance shall be measured after putting chip noise filter between the terminal 2 under the condition of opening between a and b. Every measurement the terminal 1 shall be shorted between a and b when changing noise filter.

*Except resistance of the Substrate and Wire

8. Mechanical Performance

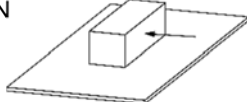
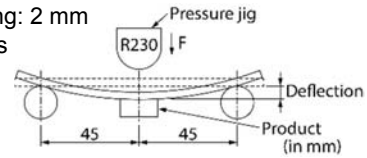
No.	Item	Specification	Test Method
8.1	Shear test	No significant mechanical damage or no sign of electrode peeling off shall be observed.	The product is soldered on a substrate for test. Applying force: 5 N Holding time: 5 s 
8.2	Bending test	No significant mechanical damage or no sign of electrode peeling off shall be observed.	The product is soldered on a substrate for test. Test substrate: glass-epoxy substrate (100 mm × 40 mm × 0.8 mm) Pressurizing speed: 1.0 mm/s Pressure jig: R230 Amount of bending: 2 mm Holding time: 20 s 
8.3	Vibration	Appearance shall have no significant mechanical damage.	The product is soldered on a substrate for test. Oscillation frequency: 10 Hz to 2000 Hz to 10 Hz/20 min Amplitude: total amplitude of 3.0 mm or acceleration amplitude of 196 m/s ² , whichever is smaller Test time: 3 directions perpendicular to each other, 2 h for each direction (6 h in total)
8.4	Solderability	95% or more of the outer electrode shall be covered with new solder seamlessly.	Flux: Ethanol solution of rosin, 25(wt)% Pre-heating: 150°C/60 s Solder: Sn-3.0Ag-0.5Cu solder Solder temperature: 245°C±3°C Immersion time: 3 s

Reference Only

Spec No. JENF243J-0017-01

P3/9

9. Environmental Performance

The product is soldered on a substrate for test.

No.	Item	Specification	Test Method
9.1	Heat life	Appearance: No significant mechanical damage shall be observed. Impedance change rate: within $\pm 30\%$ at 900 MHz	Temperature: $85^{\circ}\text{C} \pm 2^{\circ}\text{C}$ Applying Current: Rated Current Test time: 1000 h (+48 h, -0 h) Post-treatment: left for 4 hours to 48 hours at room temperature.
9.2	Cold resistance	Appearance: No significant mechanical damage shall be observed. Impedance change rate: within $\pm 30\%$ at 900 MHz	Temperature: $-40^{\circ}\text{C} \pm 2^{\circ}\text{C}$ Test time: 1000 h (+48 h, -0 h) Post-treatment: left for 4 hours to 48 hours at room temperature.
9.3	Humidity	Appearance: No significant mechanical damage shall be observed. Impedance change rate: within $\pm 30\%$ at 900 MHz	Temperature: $40^{\circ}\text{C} \pm 2^{\circ}\text{C}$ Humidity: 90% to 95% (RH) Test time: 1000 h (+48 h, -0 h) Post-treatment: left for 4 hours to 48 hours at room temperature.
9.4	Temperature Cycle	Appearance: No significant mechanical damage shall be observed. Impedance change rate: within $\pm 30\%$ at 900 MHz	Single cycle conditions: Step 1: -40°C ($+0^{\circ}\text{C}$, -3°C), 30 min (+3 min, -0 min) Step 2: ordinary temperature, 3 min max. Step 3: $+85^{\circ}\text{C}$ ($+3^{\circ}\text{C}$, -0°C), 30 min (+3 min, -0 min) Step 4: ordinary temperature, 3 min max. Number of testing: 100 cycles Post-treatment: left for 4 hours to 48 hours at room temperature.

10. Specification of Packaging

10.1 Appearance and Dimensions (8mm-wide paper tape)

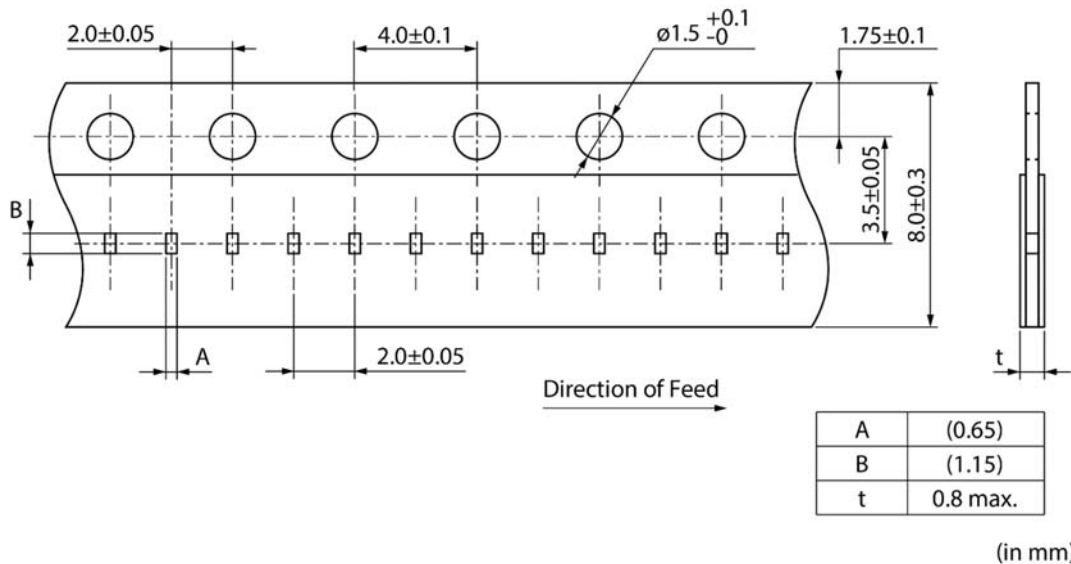

Reference Only

Spec No. JENF243J-0017-01

P4/9

10.2 Specification of Taping

- (1) Packing quantity (standard quantity)
10,000 pcs / reel
- (2) Packing Method
Products shall be packed in the cavity of base tape continuously and sealed by top tape
And bottom tape.
- (3) Sprocket hole
The sprocket holes are to the right as the tape is pulled toward the user.
- (4) Spliced point
The base tape and top tape has no spliced point.
- (5) Missing components number
Missing components number within 0.1% of the number per reel or 1 pc., whichever is greater,
and are not continuous. The Specified quantity per reel is kept.

10.3 Pull Strength

Top tape	5N min.
Bottom tape	

10.4 Peeling off force of top tape

Speed of Peeling off	300mm / min
Peeling off force	0.1N to 0.6N (minimum value is typical)

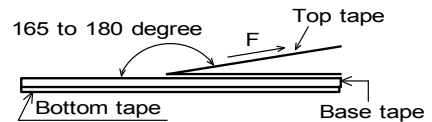

10.5 Dimensions of Leader-tape, Trailer and Reel

There shall be leader-tape (top tape) and trailer-tape (empty tape) as follows.

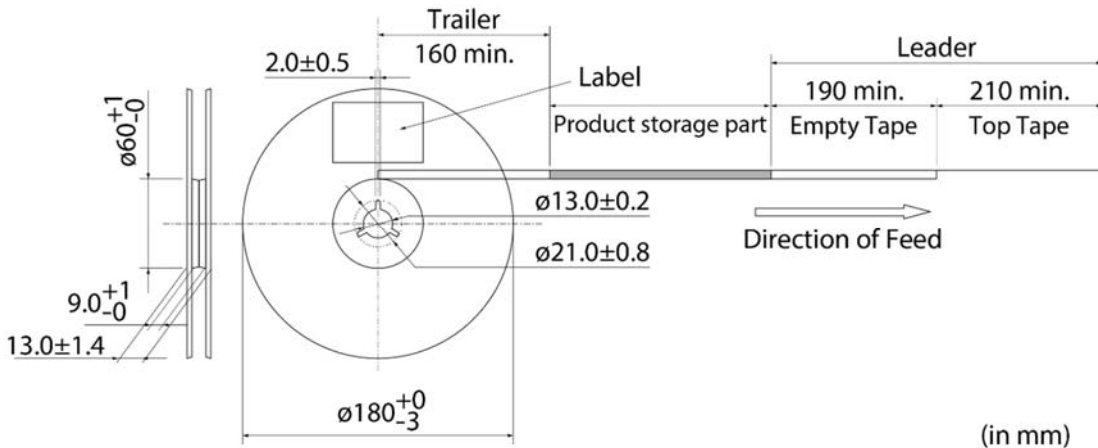

10.6 Marking for reel

Customer part number, MURATA part number, Inspection number (*1), RoHS marking (*2),
Quantity etc ...

*1) <Expression of Inspection No.>

□□
OOOO
XXX
 (1) (2) (3)

(1) Factory Code

(2) Date First digit : Year / Last digit of year
 Second digit : Month / Jan. to Sep. → 1 to 9, Oct. to Dec. → O, N, D
 Third, Fourth digit : Day

(3) Serial No.

*2) <Expression of RoHS marking >

ROHS - Y (△)
 (1) (2)

- (1) RoHS regulation conformity parts.
- (2) MURATA classification number

Reference Only

Spec No. JENF243J-0017-01

P5/9

10.7 Marking for Outside package (corrugated paper box)

Customer name, Purchasing order number, Customer part number, MURATA part number, RoHS marking (*2), Quantity, etc . . .

10.8 Specification of Outer Case

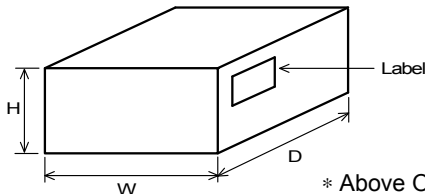

Outer Case Dimensions (mm)			Standard Reel Quantity in Outer Case (Reel)
W	D	H	
186	186	93	5

* Above Outer Case size is typical. It depends on a quantity of an order

11. ⚠ Caution

11.1 Surge current

Excessive surge current (pulse current or rush current) than specified rated current applied to the product may cause a critical failure, such as an open circuit, burnout caused by excessive temperature rise. Please contact us in advance in case of applying the surge current.

11.2 Limitation of Applications

Please contact us before using our products for the applications listed below which require especially high reliability for the prevention of defects which might directly cause damage to the third party's life, body or property.

- (1) Aircraft equipment (2) Aerospace equipment (3) Undersea equipment
- (4) Power plant control equipment (5) Medical equipment (6) Disaster prevention / crime prevention equipment
- (7) Traffic signal equipment (8) Transportation equipment (vehicles, trains, ships, etc.)
- (9) Data-processing equipment
- (10) Applications of similar complexity and /or reliability requirements to the applications listed in the above

12. Notice

This product is designed for solder mounting.

Please consult us in advance for applying other mounting method such as conductive adhesive.

12.1 Land pattern designing

The following diagram shows a recommended land dimensions for reflow soldering:

The land dimension is determined in consideration of electric characteristics and solderability. Use of other land dimension may preclude achievement of performance. In some case, it may result in poor solderability, including positional deviation. If you use other land pattern, consider it adequately.

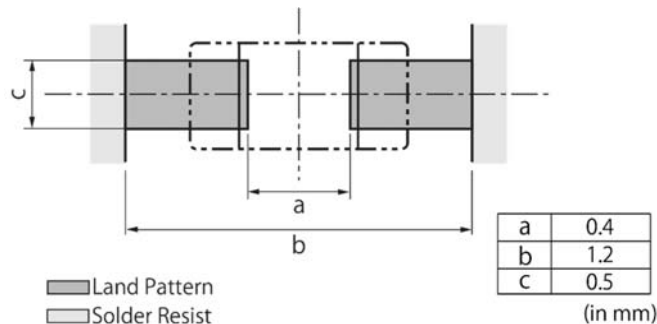

12.2 Mounting Conditions

- Please check the mounting condition before using.
- Using mounting conditions (nozzles, equipment conditions, etc.) that are not suitable for products may lead to pick up errors, misalignment, or damage to the product.

Reference Only

12.3 Flux, Solder

Flux	<ul style="list-style-type: none"> • Use a rosin-based flux. • Do not use a highly acidic flux with a halide content exceeding 0.2(wt)% (chlorine conversion value). • Do not use a water-soluble flux.
Solder	<ul style="list-style-type: none"> • Use Sn-3.0Ag-0.5Cu solder. • Standard thickness of solder paste: 100 μm to 200 μm

If you want to use a flux other than the above, please consult our technical department.

12.4 Reflow soldering conditions

- Pre-heating should be in such a way that the temperature difference between solder and product surface is limited to 150°C max. Cooling into solvent after soldering also should be in such a way that the temperature difference is limited to 100°C max. Insufficient pre-heating may cause cracks on the product, resulting in the deterioration of products quality.
- Standard soldering profile and the limit soldering profile is as follows. The excessive limit soldering conditions may cause leaching of the electrode and/or resulting in the deterioration of product quality.

Soldering Profile for Lead Free solder

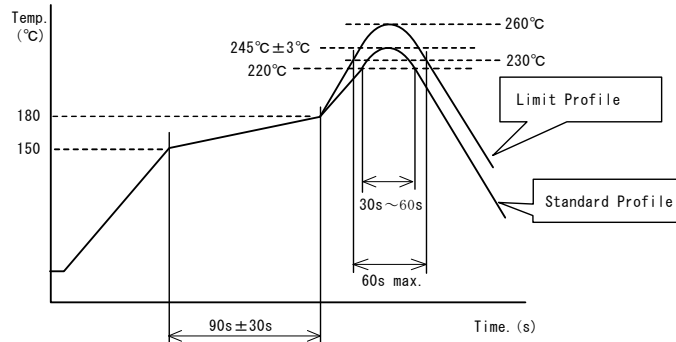

	Standard Profile	Limit Profile
Pre-heating	150°C~180°C, 90s ± 30s	
Heating	above 220°C, 30s~60s	above 230°C, 60s max.
Peak temperature	245°C ± 3°C	260°C, 10s
Cycle of reflow	2 times	

12.5 Reworking with soldering iron

- Pre-heating: 150°C, 1 min
- Soldering iron output: 80W max.
- Tip temperature: 350°C max.
- Tip diameter: φ3mm max.
- Soldering time : 3(+1,-0) seconds.
- Times : 2times max.

Note :Do not directly touch the products with the tip of the soldering iron in order to prevent the crack on the ferrite material due to the thermal shock.

12.6 Solder Volume

- Solder shall be used not to be exceeded the upper limits as shown below.
- Accordingly increasing the solder volume, the mechanical stress to Chip is also increased. Exceeding solder volume may cause the failure of mechanical or electrical performance.

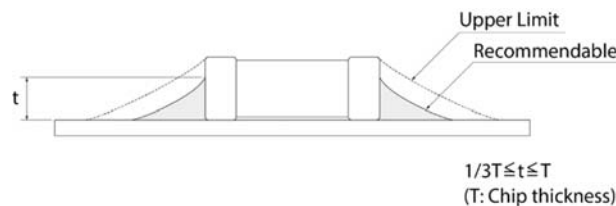

Reference Only

12.7 Product's location

The following shall be considered when designing and laying out P.C.B.'s.

- (1) P.C.B. shall be designed so that products are not subject to the mechanical stress due to warping the board.

[Products direction]

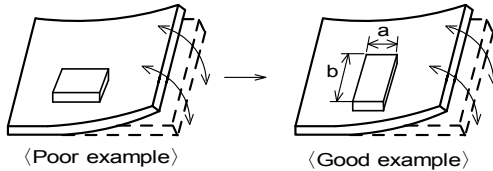

Products shall be located in the sideways direction (Length: $a \times b$) to the mechanical stress.

- (2) Components location on P.C.B. separation.

It is effective to implement the following measures, to reduce stress in separating the board.

It is best to implement all of the following three measures; however, implement as many measures as possible to reduce stress.

Contents of Measures	Stress Level
(1) Turn the mounting direction of the component parallel to the board separation surface.	$A > D^{*1}$
(2) Add slits in the board separation part.	$A > B$
(3) Keep the mounting position of the component away from the board separation surface.	$A > C$

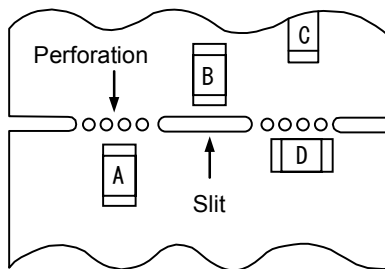

*1 $A > D$ is valid when stress is added vertically to the perforation as with Hand Separation. If a Cutting Disc is used, stress will be diagonal to the PCB, therefore $A > D$ is invalid.

- (3) Mounting Components Near Screw Holes

When a component is mounted near a screw hole, it may be affected by the board deflection that occurs during the tightening of the screw. Mount the component in a position as far away from the screw holes as possible.

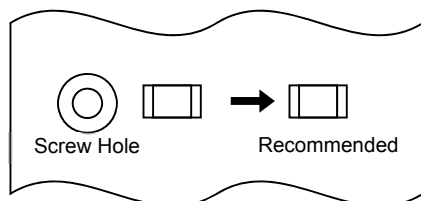

12.8 Mounting density

Add special attention to radiating heat of products when mounting the filter near the products with heating. The excessive heat by other products may cause deterioration at joint of this product with substrate.

Reference Only

Spec No. JENF243J-0017-01

P8/9

12.9 Cleaning Conditions

Products shall be cleaned on the following conditions.

- (1) Cleaning temperature shall be limited to 60°C max. (40°C max for IPA.)
- (2) Ultrasonic cleaning shall comply with the following conditions with avoiding the resonance phenomenon at the mounted products and P.C.B.
Power : 20 W / l max. Frequency : 28kHz to 40kHz Time : 5 min max.
- (3) Cleaner
 1. Alcohol type cleaner
Isopropyl alcohol (IPA)
 2. Aqueous agent
PINE ALPHA ST-100S
- (4) There shall be no residual flux and residual cleaner after cleaning. In the case of using aqueous agent, products shall be dried completely after rinse with de-ionized water in order to remove the cleaner.
- (5) Other cleaning Please contact us.

12.10 Operating Environment

Do not use this product under the following environmental conditions, on deterioration of the Insulation Resistance of the Ferrite material and/or corrosion of Inner Electrode may result from the use.

- (1) in the corrodible atmosphere such as acidic gases, alkaline gases, chlorine, sulfur gases, organic gases and etc. (the sea breeze, Cl₂, H₂S, NH₃, SO₂, NO₂, etc)
- (2) in the atmosphere where liquid such as organic solvent, may splash on the products.
- (3) in the atmosphere where the temperature / humidity changes rapidly and it is easy to dew.

12.11 Resin coating

The impedance value may change and/or it may affect on the product's performance due to high cure-stress of resin to be used for coating / molding products. So please pay your careful attention when you select resin. In prior to use, please make the reliability evaluation with the product mounted in your application set.

12.12 Caution for use

There is possibility that the impedance value change due to magnetism. Don't use a magnet or a pair of tweezers with magnetism when chip noise filters are handled. (The tip of the tweezers should be molded with resin or pottery.)

12.13 Handling of a substrate

After mounting products on a substrate, do not apply any stress to the product caused by bending or twisting to the substrate when cropping the substrate, inserting and removing a connector from the substrate or tightening screw to the substrate.

Excessive mechanical stress may cause cracking in the product.

Bending

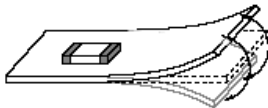

Twisting

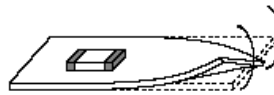

Reference Only

Spec No. JENF243J-0017-01

P9/9

12.14 Storage and Handling Requirements

(1) Storage period

Use the products within 6 months after delivered.
Solderability should be checked if this period is exceeded.

(2) Storage conditions

•Products should be stored in the warehouse on the following conditions.

Temperature : -10°C to 40°C

Humidity : 15% to 85% relative humidity No rapid change on temperature and humidity

Don't keep products in corrosive gases such as sulfur, chlorine gas or acid, or it may cause oxidization of electrode, resulting in poor solderability.

•Products should be stored on the palette for the prevention of the influence from humidity, dust and so on.

•Products should be stored in the warehouse without heat shock, vibration, direct sunlight and so on.

•Products should be stored under the airtight packaged condition.

(3) Handling Condition

Care should be taken when transporting or handling product to avoid excessive vibration or mechanical shock.

13. Note

(1) Please make sure that your product has been evaluated in view of your specifications with our product being mounted to your product.

(2) You are requested not to use our product deviating from the agreed specifications.

(3) The contents of this reference specification are subject to change without advance notice. Please approve our product specifications or transact the approval sheet for product specifications before ordering.