

Chip Ferrite Bead BLT5BPT680LN1 □	Reference Specification
--	--------------------------------

1. Scope

This reference specification applies to Chip Ferrite Bead BLT5BP Series.

2. Part Numbering

(Ex.)	BL	T	5B	PT	680	L	N	1	L
	Product ID	Type	Dimension (L×W)	Characteristics	Typical Impedance at 100MHz	Performance	Category	Numbers of Circuit	Packaging
									L : Taping B : Bulk

3. Rating

Customer Part Number	MURATA Part Number	Impedance (Ω) (at 10MHz, Under Standard Testing Condition)	Impedance (Ω)Typ. (at 100MHz, Under Standard Testing Condition)	Rated Current (A)		DC Resistance (mΩ max.)
				at 85°C	at 150°C	
	BLT5BPT680LN1L	10±50%	68	11	4.5	10
	BLT5BPT680LN1B					

Rated Current are measured based on Item10.1.

■ Operating Temperature : -55°C to +150°C ■ Storage Temperature : -55°C to +150°C

■ Rated Current is derated as below figure depending on the operating temperature.

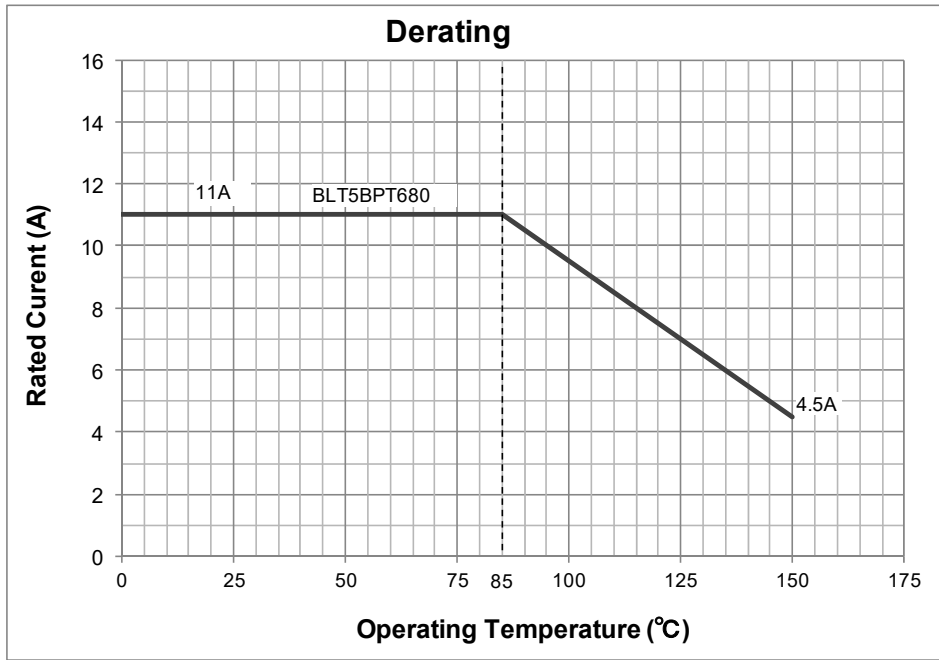

4. Standard Testing Conditions

< Unless otherwise specified >

Temperature: Ordinary Temp. 15 °C to 35 °C
 Humidity: Ordinary Humidity 25 %(RH) to 85 %(RH)

< In case of doubt >

Temperature: 20 °C ± 2 °C
 Humidity: 60 %(RH) to 70 %(RH)
 Atmospheric pressure: 86 kPa to 106 kPa

5. Style and Dimensions

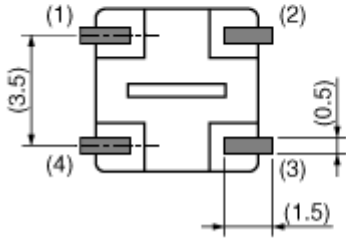
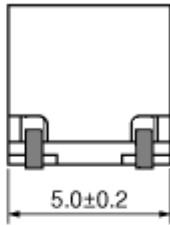
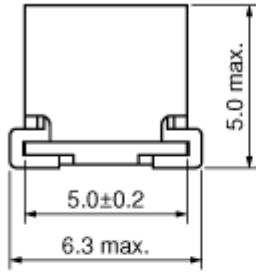

— : Electrode
 () : Reference Value
 (in : mm)

Equivalent Circuit

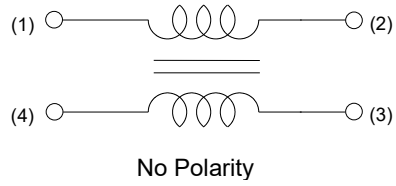

Unit Mass (Typical value)

0.48g

6. Marking

No Marking.

7. Electrical Performance

No.	Item	Specification	Test method
7.1	Impedance	Meet item 3	Measuring Equipment: KEYSIGHT 4991A or the equivalent Measuring Frequency: 10MHz (ref.item 10)
7.2	DC Resistance (Rdc)	Meet item 3	Measuring Current : 100mA (ref.item 10) (In case of doubt in the above mentioned standard condition, measure by 4 terminal method.)

8. Mechanical performance

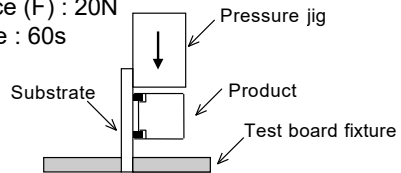
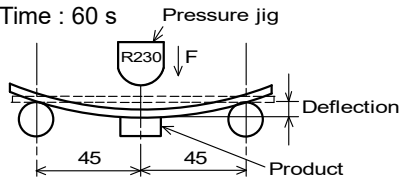
No.	Item	Specifications	Test Method								
8.1	Appearance and Dimensions	Meet item 5.	Visual Inspection and measured with Slide Calipers.								
8.2	Bonding Strength and Core Strength	No evidence of coming off substrate. Products shall not be mechanical damaged.	Applying Force (F) : 20N Applying Time : 60s 								
8.3	Bending Strength	Meet Table 1. <table border="1" data-bbox="469 1565 834 1742"> <thead> <tr> <th colspan="2">Table 1</th> </tr> </thead> <tbody> <tr> <td>Appearance</td> <td>No damaged.</td> </tr> <tr> <td>Impedance Change (at 10MHz)</td> <td>within ± 20%</td> </tr> <tr> <td>DC Resistance</td> <td>Meet item 3</td> </tr> </tbody> </table>	Table 1		Appearance	No damaged.	Impedance Change (at 10MHz)	within ± 20%	DC Resistance	Meet item 3	Substrate : Glass-epoxy (t=1.6mm) Deflection : 2mm Keeping Time : 60 s 
Table 1											
Appearance	No damaged.										
Impedance Change (at 10MHz)	within ± 20%										
DC Resistance	Meet item 3										
8.4	Resistance to Soldering heat (Reflow)		Solder : Sn-3.0Ag-0.5Cu Pre heating : 150~180°C , 90±30s Heating : above 230°C , 60s max. Peak temperature : 260°C , 10s Cycle of reflow : 2 times Then measured after exposure in the room condition for 4 to 48 hours.								

No.	Item	Specifications	Test Method
8.5	Vibration	Meet Table 1.	Products shall be soldered on the substrate. Oscillation Frequency : 10 to 2000 to 10Hz for 20 min. Speed of acceleration : 5G Testing Time: A period of 4 hours in each of 3 mutually perpendicular directions. (Total 12 h)
8.6	Shock		It shall be soldered on the substrate. Peak Acceleration : 14,700 m / s ² Normal Duration : 0.5 ms Wave form : Half-sine wave Times : 3 shocks in each 6 directions (total 18times)
8.7	Solderability	The electrodes shall be at least 90% covered with new solder coating.	Flux : Ethanol solution of rosin,25(wt)% Pre heating : 150 ± 5°C, 60±5s Solder : Sn-3.0Ag-0.5Cu Solder Temperature : 245±3°C Immersion Time : 5±1s Immersion and Immersion rates : 25mm/s

9. Environmental Performance

It shall be soldered on the substrate.

No.	item	specification	test method
9.1	heat shock	Meet Table 1	1 cycle : 1 step : -55 °C(+0 °C,-3 °C) / 30min(+3min,-0min) 2 step : 150 °C (+3°C,-0 °C) / 30min(+3min,-0min) Total of 100 cycles Then measured after exposure in the room condition for 48h± 4h.
9.2	Humidity		Temperature: 85°C±2°C Humidity : 80~85%(RH) Time: 1000+48/-0 h Then measured after exposure in the room condition for 48±4 h
9.3	Heat life		Temperature:150°C ±2 °C Voltage: Rated Current (at 150°C) Time: 1000+48/-0h Then measured after exposure in the room condition for 48±4 h

10. Measuring Terminal

(When measuring and supplying the voltage, the following terminal is applied.)

No.	Item	Measuring terminal
10.1	Impedance Heat life	
10.2	DC Resistance (Rdc)	

11. Impedance frequency characteristics (typical)

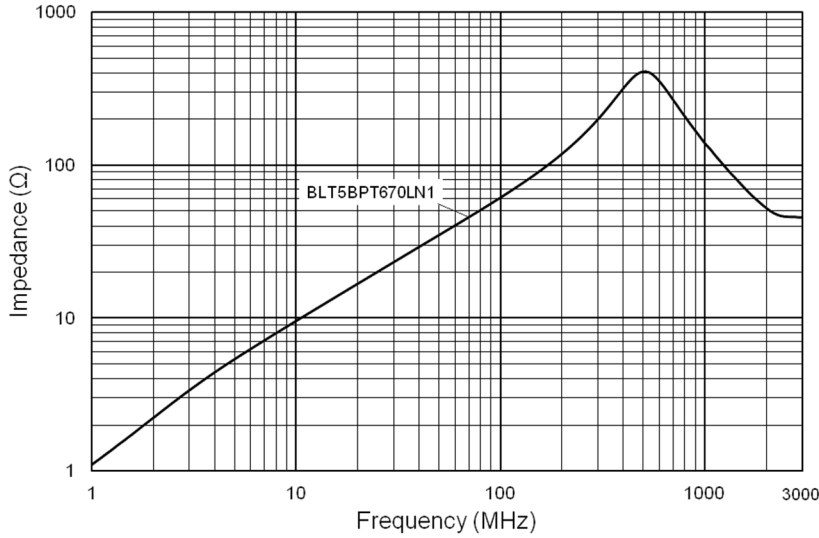

12. Specification of Packaging

12.1 Appearance and Dimensions (12mm-wide, Plastic tape)

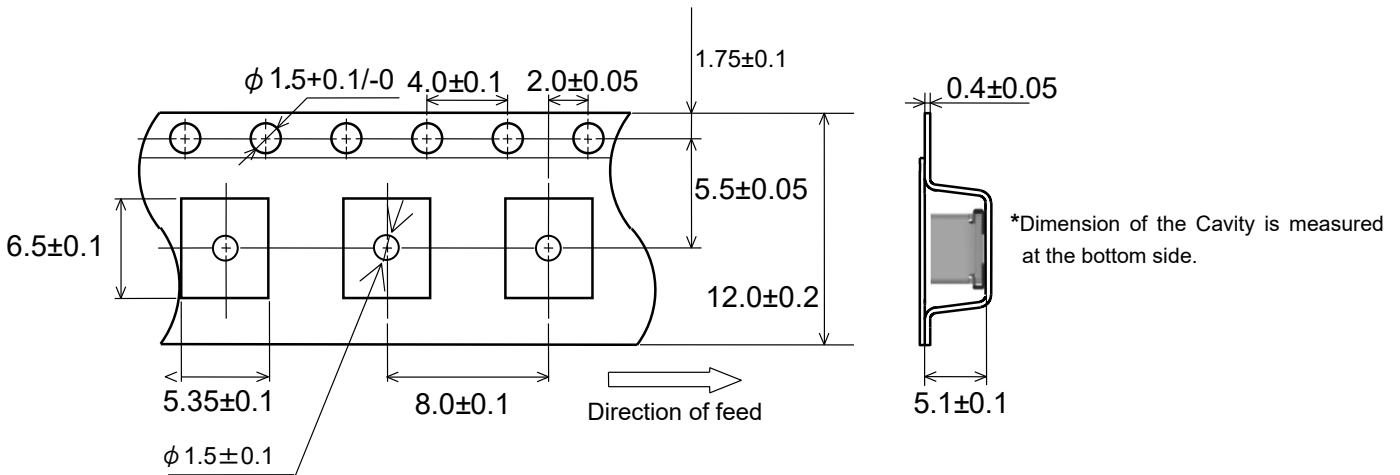

12.2 Specification of Taping

- (1) Packing quantity (Standard quantity)
Φ180 mm reel: 300pcs. / reel
- (2) Packing Method
Products shall be packaged in each embossed cavity of plastic tape and sealed with cover tape.
- (3) Sprocket Hole
The sprocket holes are to the right as the tape is pulled toward the user.
- (4) Spliced point
The cover tape has no spliced point.
- (5) Missing components number
Missing components number within 0.025% of the number per reel or 1 pc., whichever is greater, and are not continuous. The specified quantity per reel is kept.

12.3 Pull Strength of Cover Tape

Plastic Tape	5 N min.
Cover Tape	10 N min.

12.4 Peeling off force of Cover Tape

0.2N to 0.7N (minimum value is typical.)
Speed of Peeling off: 300 mm / min

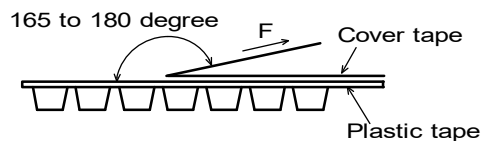

13. ⚠ Caution

13.1 Terminal connection

The terminations shall be connected correctly.
The product consists of two coils.

In order to provide the appropriate performance, two terminations shall be connected to the single power line and used as one coil.

If the terminations are connected to the power line and ground line separately, serious problems such as open circuit, short circuit, or flames might be caused due to extreme heat generation.

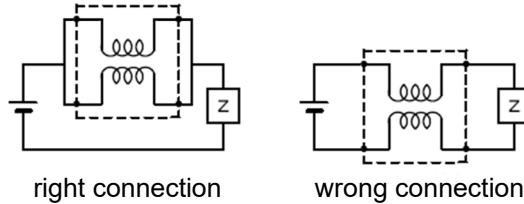

13.2 Limitation of Applications

Please contact us before using our products for the applications listed below which require especially high reliability for the prevention of defects which might directly cause damage to the third party's life, body or property.

- (1) Aircraft equipment
- (2) Aerospace equipment
- (3) Undersea equipment
- (4) Power plant control equipment
- (5) Medical equipment
- (6) Transportation equipment (vehicles, trains, ships, etc.)
- (7) Traffic signal equipment
- (8) Disaster prevention / crime prevention equipment
- (9) Data-processing equipment
- (10) Applications of similar complexity and /or reliability requirements to the applications listed in the above

13.3 Caution(Rating)

Do not exceed maximum rated current of the product. Thermal stress may be transmitted to the product and short/open circuit of the product or falling off the product may be occurred.

13.4 Fail Safe

Be sure to provide an appropriate fail-safe function on your product to prevent from a second damage that may be caused by the abnormal function or the failure of our products.

13.5 Attention regarding product's heat generation

Please pay special attention to the product's heat generation such as beyond Operating Temperature range, mounting product in close proximity to other products that radiate heat and beyond the rated current.

14. Notice

Products can only be soldered with reflow.

This product is designed for solder mounting.

Please consult us in advance for applying other mounting method such as conductive adhesive.

14.1 Flux and Solder

Flux	Use rosin-based flux, (with converting chlorine content 0.06 to 0.1(wt)%), but not highly acidic flux (with Halogen content exceeding 0.2(wt)% conversion to chlorine). Do not use water-soluble flux.
Solder	Use Sn-3.0Ag-0.5Cu solder

14.2 Notes for Assembling

<Exclusive Use of Reflow Soldering>

When installing by the flow soldering, the degradation of the insulation coating sometimes occurs.

Products can only be soldered with reflow.

The use in flow soldering is reserved.

14.3 Cleaning Conditions

Do not clean after soldering.

14.4 Attention Regarding P.C.B. Bending

The following shall be considered when designing P.C.B.'s and laying out products.

- (1) P.C.B. shall be designed so that products are not subject to the mechanical stress for board warpage.

[Products Direction]

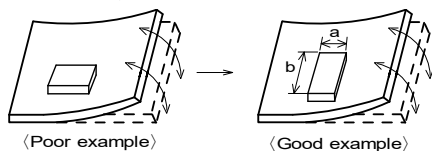

Products shall be located in the sideways direction (Length: a < b) to the mechanical stress.

(2) Components location on P.C.B. separation.

It is effective to implement the following measures, to reduce stress in separating the board.
 It is best to implement all of the following three measures; however, implement as many measures as possible to reduce stress.

Contents of Measures	Stress Level
(1) Turn the mounting direction of the component parallel to the board separation surface.	$A > D *1$
(2) Add slits in the board separation part.	$A > B$
(3) Keep the mounting position of the component away from the board separation surface.	$A > C$

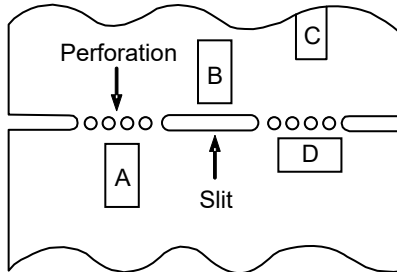

*1 $A > D$ is valid when stress is added vertically to the perforation as with Hand Separation.
 If a Cutting Disc is used, stress will be diagonal to the PCB, therefore $A > D$ is invalid.

(3) Mounting Components Near Screw Holes

When a component is mounted near a screw hole, it may be affected by the board deflection that occurs during the tightening of the screw. Mount the component in a position as far away from the screw holes as possible.

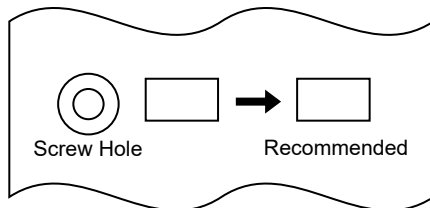

14.5 Attention Regarding P.C.B. Design

< The Arrangement of Products >
 P.C.B. shall be designed so that products are far from the portion of perforation.

The portion of perforation shall be designed as narrow as possible, and shall be designed so as not to be applied the stress in the case of P.C.B. separation.

Products shall not be arranged on the line of a series of holes when there are big holes in P.C.B.
 (Because the stress concentrates on the line of holes.)

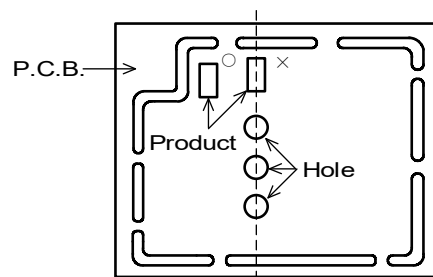
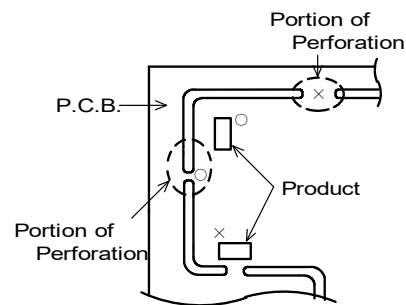

< At 2nd reflow soldering process >
 At 2nd reflow soldering process, the product mounted on PCB might be dropped off due to its weight.
 Please take care for preventing the dropping off.

< Products Placing >
 Support pins shall be set under P.C.B. to prevent causing a warp to P.C.B. during placing the products on the otherside of P.C.B.

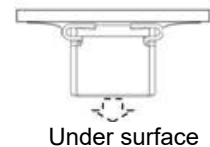

< P.C.B. Separation >
 P.C.B. shall not be separated with hand.
 P.C.B. shall be separated with the fixture so as not to cause P.C.B. bending.

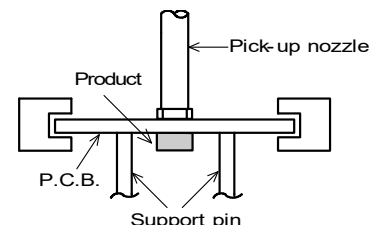

14.6 Standard Land Dimensions

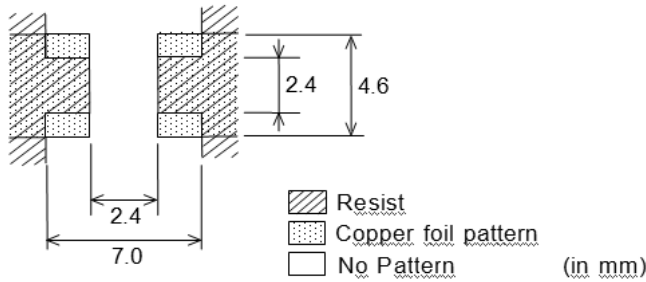

14.7 Standard Soldering Condition

1.Reflow Soldering

(1) Soldering conditions

- Pre-heating should be in such a way that the temperature difference between solder and ferrite surface is limited to 150°C max. Also cooling into solvent after soldering should be in such a way that the temperature difference is limited to 100°C max.
Insufficient pre-heating may cause cracks on the ferrite, resulting in the deterioration of product quality.
- Standard soldering profile and the limit soldering profile is as follows.
The excessive limit soldering conditions may cause leaching of the electrode and / or resulting in the deterioration of product quality.

(2) Soldering Conditions

Standard soldering profile and the limit soldering profile is as follows.

The excessive limit soldering conditions may cause leaching of the electrode and / or resulting in the deterioration of product quality.

- Soldering Profile for Lead Free solder (Sn-3.0Ag-0.5Cu solder)

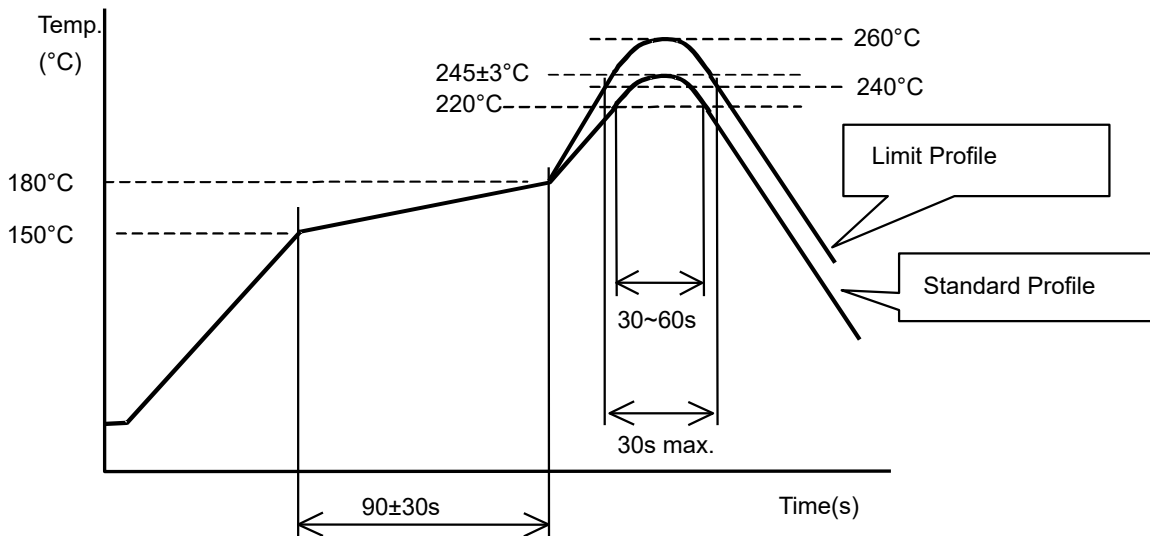

	Standard Profile	Limit Profile
Pre-heating	150°C ~ 180°C , 90s ± 30s	
Heating	above 220°C , 30s ~ 60s	above 240°C , 30s max.
Peak temperature	245°C ± 3°C	260°C , 10s
Cycle of reflow	2 times	2 times

2. Solder paste printing for reflow soldering

- Standard thickness of solder paste should be 150 μm.
Incidentally, depending on the reflow condition and the way of heat conduction, the solder would not wet up the terminal, being possible to lead to not enough connection between terminals and lands on the circuit board / open circuit in the circuit board. In case of use, always evaluate this part in your products with actual use condition.
- For the solder paste printing pattern, use standard land dimensions.
- For the resist and copper foil pattern, use standard land dimensions.
- Use Sn-3.0Ag-0.5Cu solder

3. Reworking with Soldering iron

- The following conditions shall be strictly followed when using a soldering iron.
 - Pre-heating: 150°C, 1 min
 - Soldering iron output: 30W max.
 - Tip temperature: 350°C max.
 - Tip diameter: φ3mm max.
 - Soldering time : 3(+1,-0) seconds.
 - Times : 2times max.

Notes: Do not touch the products directly with the soldering iron.

4. Solder Volume

Solder shall be used not to be exceeded the upper limits as shown below.

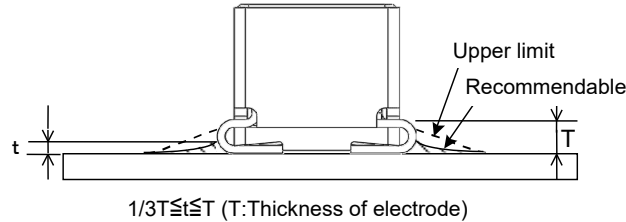

Accordingly increasing the solder volume, the mechanical stress to Chip is also increased. Exceeding solder volume may cause the failure of mechanical or electrical performance. In case if the solder volume is much, we recommend to make the size of the solder paste with less than the land pattern.

14.8 Caution for use

- When you hold products with a tweezer, please hold like a figure of the right side, and sharp material, such as a pair of tweezers, shall not be touched to the Electrode.
- Mechanical shock should not be applied to the products mounted on the board to prevent the damage to electrode.

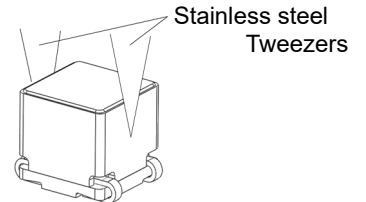

Handling of a substrate

After mounting products on a substrate, do not apply any stress to the product caused by bending or twisting to the substrate when cropping the substrate, inserting and removing a connector from the substrate or tightening screw to the substrate.

Excessive mechanical stress may cause cracking in the product.

Bending

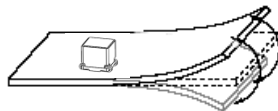

Twisting

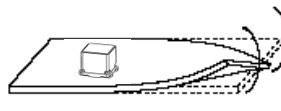

14.9 Operating Environment

Do not use this product under the following environmental conditions, on deterioration of the Insulation Resistance and/or corrosion of Inner Electrode may result from the use.

- (1) In the corrodible atmosphere (acidic gas, alkaline gas, chlorine, sulfur gas, organic gas and etc.)
- (2) In the atmosphere where liquid such as organic solvent, may splash on the products.
- (3) In the atmosphere where the temperature / humidity changes rapidly and it is easy to dew.
- (4) In the atmosphere where the product is covered with dust or is subjected to salty breeze.

14.10 Storage Conditions

(1) Storage period

Use the products within 12 months after delivered.
Solderability should be checked if this period is exceeded.

(2) Storage conditions

- Products should be stored in the warehouse on the following conditions.
 - Temperature: -10°C to 40°C
 - Humidity: 15% to 85% relative humidity
 - No rapid change on temperature and humidity
- Don't keep products in corrosive gases such as sulfur, chlorine gas or acid, or it may cause oxidization of electrode, resulting in poor solderability.
- Products should be stored on the palette for the prevention of the influence from humidity, dust and so on.
- Products should be stored in the warehouse without heat shock, vibration, direct sunlight and so on.
- Avoid storing the product by itself bare (i.e. exposed directly to air).

(3) Delivery

Care should be taken when transporting or handling product to avoid excessive vibration or mechanical shock.

15.  **Note**

- (1) Please make sure that your product has been evaluated in view of your specifications with our product being mounted to your product.
- (2) You are requested not to use our product deviating from the reference specifications.
- (3) The contents of this reference specification are subject to change without advance notice. Please approve our product specifications or transact the approval sheet for product specifications before ordering.