

Transformers for switching power supplies
Pin terminal type



ECO2230SEO-D04V016

FEATURES

- Downsized yet compliant with worldwide safety standards.
- Supports automatic winding.
- Considerably reduced characteristic variations.

APPLICATION

- Isolation type Single-output power supplies
- Input : 90 to 264Vac
- 1 Output : 12V/2.0A
- Circuit type : PWM flyback
- frequency : 100kHz

REFERENCE TEST BOARD

- AN-EVAL-ICE3AR1080VJZ (infineon)

ECO2230SEO-D04V016

SHAPE & DIMENSIOS

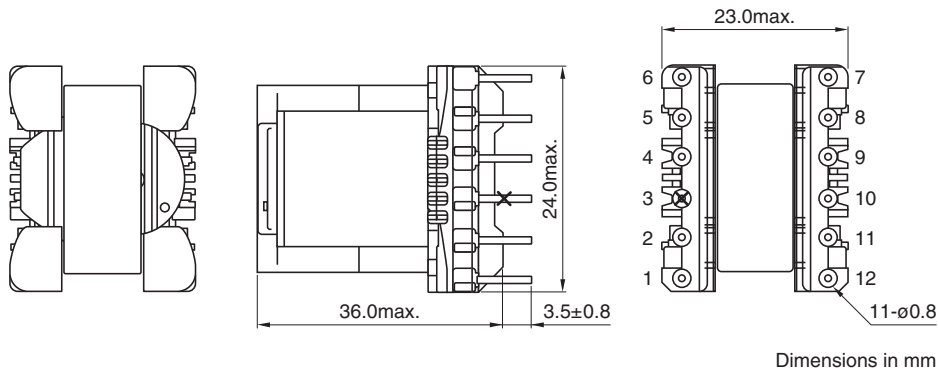

RECOMMENDED BASE MATERIAL OPENING SIZE

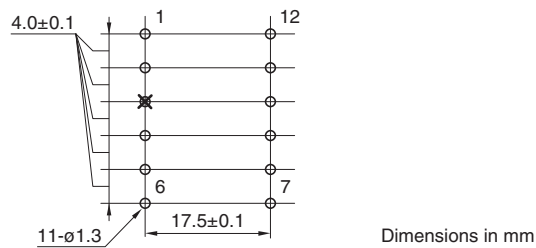

[Top View]

SCHEMATICS

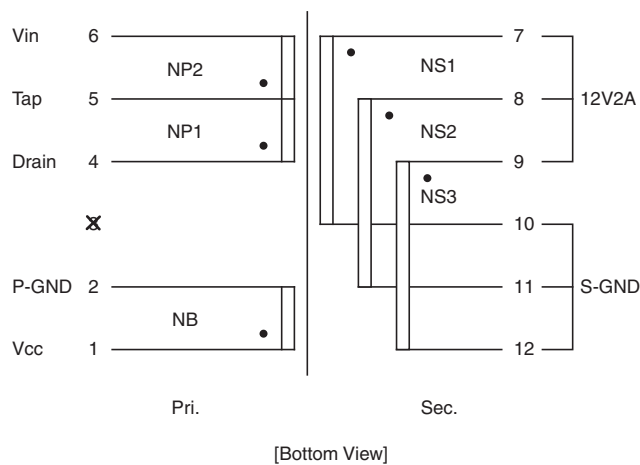

ECO2230SEO-D04V016

WINDING SPECIFICATIONS

No.	Coil	Terminal	Turns	Wire	Rdc(m Ω)* ¹	Note* ²
1	NP1	4 - 5	28	UEW 0.25X2	172	Clock wise (NP1 + NP2 =56Ts)
2	NB	1 - 2	12	UEW 0.25X2	85.9	
3	NS1	7 - 10	10	UEW 0.40X2	31.0	Clock wise
4	NS2	8 - 11	10	UEW 0.40X2	33.0	Clock wise
5	NS3	9 - 12	10	UEW 0.40X2	35.5	Clock wise
6	NP2	5 - 6	28	UEW 0.25X2	251	Clock wise
7						
8						
9						
10						

*1 Rdc value is a reference.

*2 Clockwise direction is an order direction when see a transformer from the upper part.

ECO2230SEO-D04V016

ELECTRICAL CHARACTERISTICS

Inductance*1 NP (μH)	Tolerance	Leakage inductance*1 NP(NB,NS all shorted) (μH)max.	Withstanding voltage*2		Insulation resistance	
			Pri. - Sec.	Coil - Core	Pri. - Sec.	Coil - Core
250	$\pm 10\%$	6.8	AC3.0kVrms 1min or AC 3.6kVrms 1s	AC1.5kVrms 1min or AC 1.8kVrms 1s	DC500V 100M Ω min.	DC500V 100M Ω min.

*1 Measurement Condition : 100kHz, 1V

*2 Measurement Condition : Sense 1.0mA, f=50 or 60Hz

SAFETY DISTANCE

	Creepage distance	Air clearance
Pri.-Sec.	4.0mm min. (CTI I) 6.0mm min. (CTI III)	4.0mm min.
Coil-Core	2.0mm min. (CTI I) 3.0mm min. (CTI III)	2.0mm min.

INDUCTANCE CHANGE VS. BIAS CHARACTERISTICS

I _{dc} (A)	25°C (μH)	100°C (μH)
0	253	264
1.5	251	263
1.8	250	262
2.1	248	260
2.4	246	259
2.7	243	255
3.0	238	246
3.6	221	209
3.9	206	136
4.2	184	89

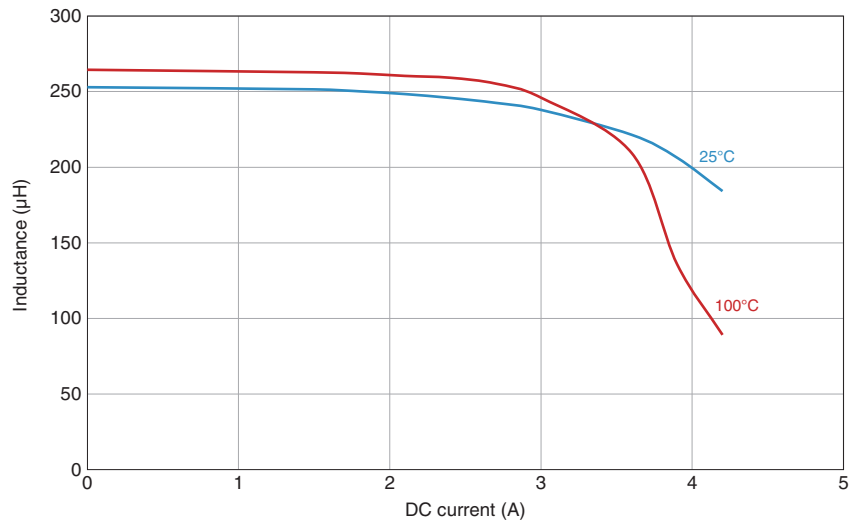

ECO2230SEO-D04V016

RELIABILITY TESTS

Item	Standards	Test methods
Vibration resistance		Sweep 1.5mm amplitude and 10-to-55-to-10Hz in 1min in X, Y, and Z directions for 2h respectively.
Heat resistance		Measure in normal temperature after leaving in 100±2°C for 96h.
Cold resistance	Standard of inductance, insulation resistance, withstand voltage must be satisfied.	Measure in normal temperature after leaving in -40±2°C for 96h.
Humidity resistance		Measure in normal temperature after leaving in 60±2°C and 90 to 95(%)RH for 96h.
Temperature cycle		One cycle is -25°C for 30min, normal temperature for 30min, and 85°C for 30min; measure after 10 cycles of the test have been performed.
Terminal strength	9.8N min.	Apply 9.8N load in the direction of terminal axis for 30±5s. Any terminal must not be pulled out or chatter.
Solderability	Solder covers more than 90%.	Dip in solder with the temperature of 245±2°C for 3±0.5s.

NOTE

Operation Range after the assembly

- Temperature : -25°C to +115°C
(Including self temperature rise.)
- Humidity : 10 to 95%RH
(Maximum wet-bulb temperature is 38°C, without dewing)

Storage Range after the assembly

- Temperature : -25°C to +80°C
- Humidity : 10 to 95%RH
(Maximum wet-bulb temperature is 38°C, without dewing)

Applicable Safety Standard

- IEC600335-1, IEC61558-1 (Basic Insulation)
Electrical Appliance and Material Safety Act /Japan (Basic Insulation)
IEC62368-1 (Reinforced Insulation)

*Working voltage \leq 300Vrms, Pollution degree 2

*Product is not approved to the above standard. But construction and materials are designed in accordance with safety considerations.

ECO2230SEO-D04V016

INPUT / OUTPUT OVERVIEW

Description	Symbol	Min.	Typ.	Max.	Unit	Condition
Input	Voltage	Vin	90	264	Vac	
	Frequency	f _{ac}	47	50 / 60	63	Hz
	Power Factor	PF	—	0.45	—	90 to 264Vac, Pomax
	No Load Input Power	P _{nl}			89	mW 100Vac / 230Vac
Output	Voltage	Vout	11.4	12.0	12.6	Vdc
	Current	I _{out}	0	2.0	2.0	A
	Ripple Voltage	V _{ripple}	—	—	100	mV 20MHz Bandwidth, 90 to 264Vac, Pomax
	Efficiency	Eff	—	82 / 84	—	% 100Vac / 230Vac, Pomax

TEMPERATURE RISE

No.	Component	90Vac		100Vac		230Vac		264Vac	
		(°C)	ΔT (°C)	(°C)	ΔT (°C)	(°C)	ΔT (°C)	(°C)	ΔT (°C)
1	Ambient	24.0	—	24.0	—	23.0	—	23.0	—
2	CM choke	47.6	23.6	40.2	16.2	32.6	9.6	31.6	8.6
3	BR1	41.6	17.6	39.4	15.4	33.7	10.7	33.2	10.2
4	VAR	35.7	11.7	34.8	10.8	28.1	5.1	29.1	6.1
5	C3	41.1	17.1	37.8	13.8	34.8	11.8	36.5	13.5
6	IC	51.5	27.5	52.5	28.5	51.4	28.4	52.4	29.4
7	D1	56.1	32.1	53.5	29.5	50.8	27.8	50.1	27.1
8	TR1 (wire)	49.2	25.2	49.6	25.6	52.9	29.9	53.7	30.7
9	TR1 (core)	42.4	18.4	42.7	18.7	45.6	22.6	47.0	24.0
10	D3	51.9	27.9	52.3	28.3	52.3	29.3	55.9	32.9
11	L2	40.2	16.2	37.0	13.0	35.1	12.1	34.6	11.6
12	C8	42.0	18.0	39.0	15.0	41.3	18.3	40.0	17.0
13	C9	43.0	19.0	40.0	16.0	41.4	18.4	41.0	18.0

Note: Test transformer was away from PWB surface about 3cm.

ECO2230SEO-D04V016

LOAD REGULATION

Input voltage (Vac)	12V Output current (%)	(A)	Input power (W)	Input current (A)	Power factor	12V Voltage (Vdc)	Efficiency (%)
90	0%	0.00	0.044	0.013	0.04	12.05	0.0
	5%	0.10	1.530	0.044	0.37	12.05	78.7
	10%	0.20	2.986	0.082	0.42	12.05	80.7
	25%	0.50	7.310	0.171	0.47	12.05	82.4
	50%	1.00	14.510	0.308	0.52	12.05	83.0
	75%	1.50	21.870	0.439	0.55	12.05	82.6
	100%	2.00	29.380	0.566	0.57	12.04	82.0
100	0%	0.00	0.046	0.015	0.03	12.05	0.0
	5%	0.10	1.532	0.042	0.36	12.05	78.7
	10%	0.20	2.940	0.073	0.40	12.05	82.0
	25%	0.50	7.260	0.161	0.45	12.05	83.0
	50%	1.00	14.480	0.294	0.49	12.05	83.2
	75%	1.50	21.690	0.418	0.51	12.05	83.3
	100%	2.00	29.060	0.537	0.54	12.05	82.9
230	0%	0.00	0.089	0.034	0.01	12.05	0.0
	5%	0.10	1.600	0.041	0.17	12.05	75.3
	10%	0.20	3.200	0.052	0.26	12.05	75.3
	25%	0.50	7.650	0.094	0.35	12.05	78.7
	50%	1.00	14.670	0.161	0.39	12.05	82.1
	75%	1.50	21.580	0.223	0.42	12.05	83.7
	100%	2.00	28.530	0.285	0.43	12.04	84.4
264	0%	0.00	0.109	0.039	0.01	12.05	0.0
	5%	0.10	1.620	0.044	0.14	12.05	74.4
	10%	0.20	3.220	0.056	0.25	12.05	74.8
	25%	0.50	7.700	0.087	0.33	12.05	78.2
	50%	1.00	14.620	0.145	0.38	12.05	82.4
	75%	1.50	21.630	0.201	0.40	12.05	83.5
	100%	2.00	28.600	0.255	0.42	12.04	84.2

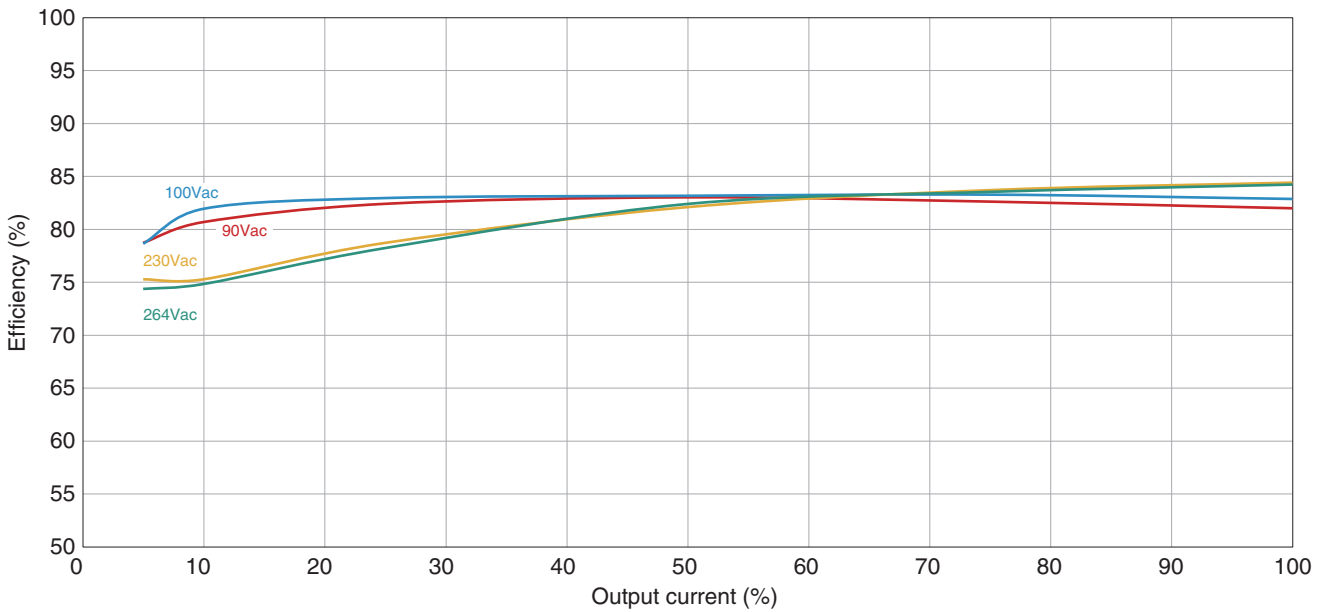

ECO2230SEO-D04V016

REFERENCE WAVEFORM

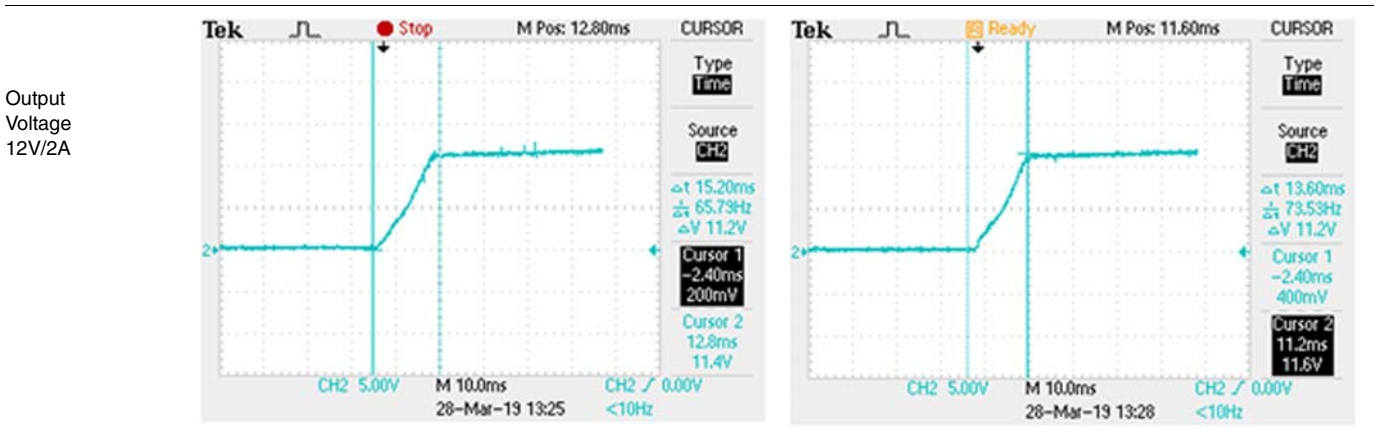
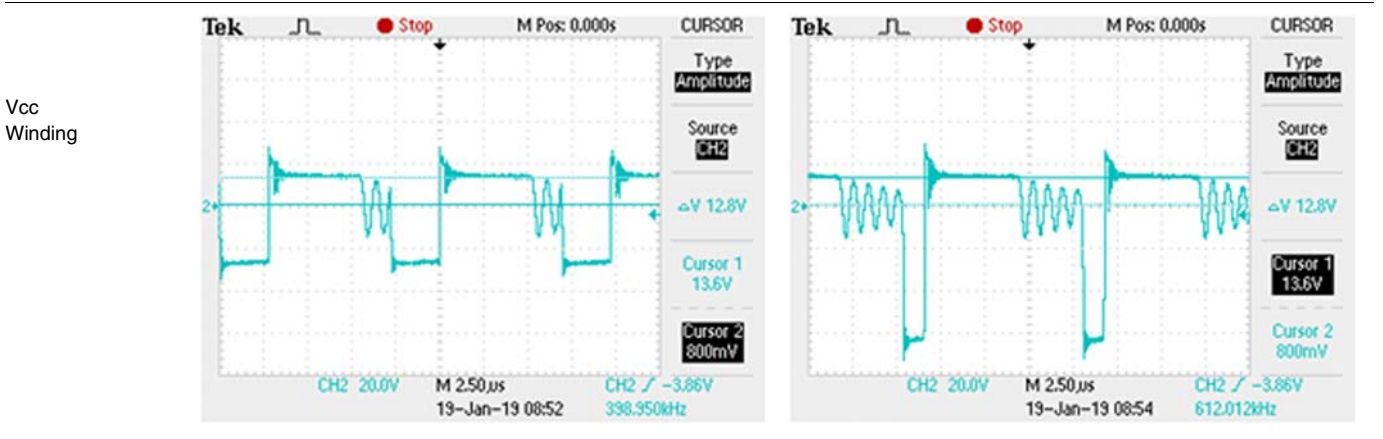
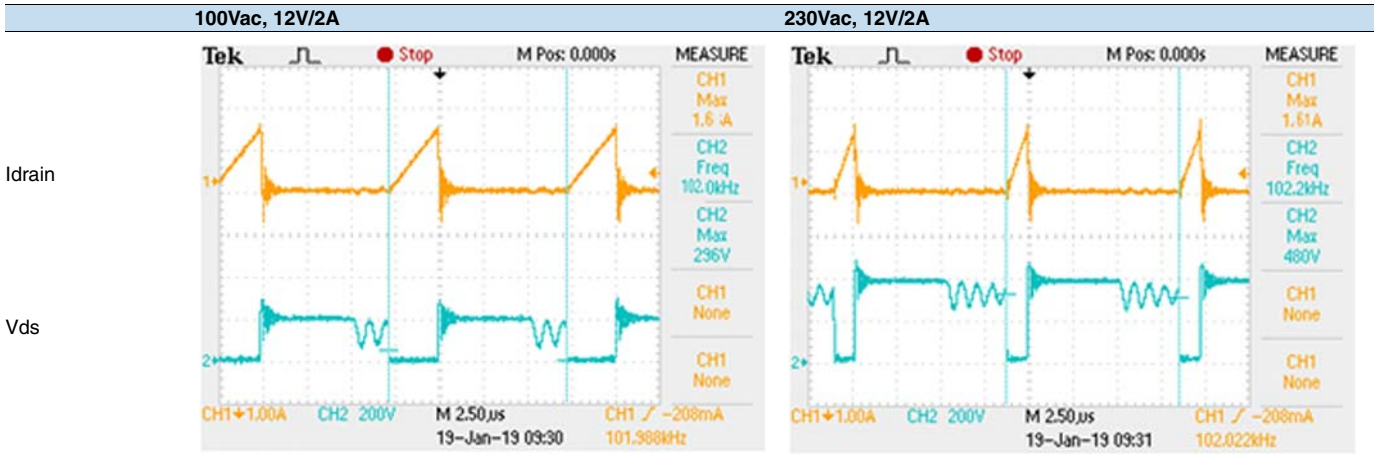

⚠ Please be sure to request delivery specifications that provide further details on the features and specifications of the products for proper and safe use. (8/10)
Please note that the contents may change without any prior notice due to reasons such as upgrading.

ECO2230SEO-D04V016

REFERENCE SCHEMATIC DIAGRAM

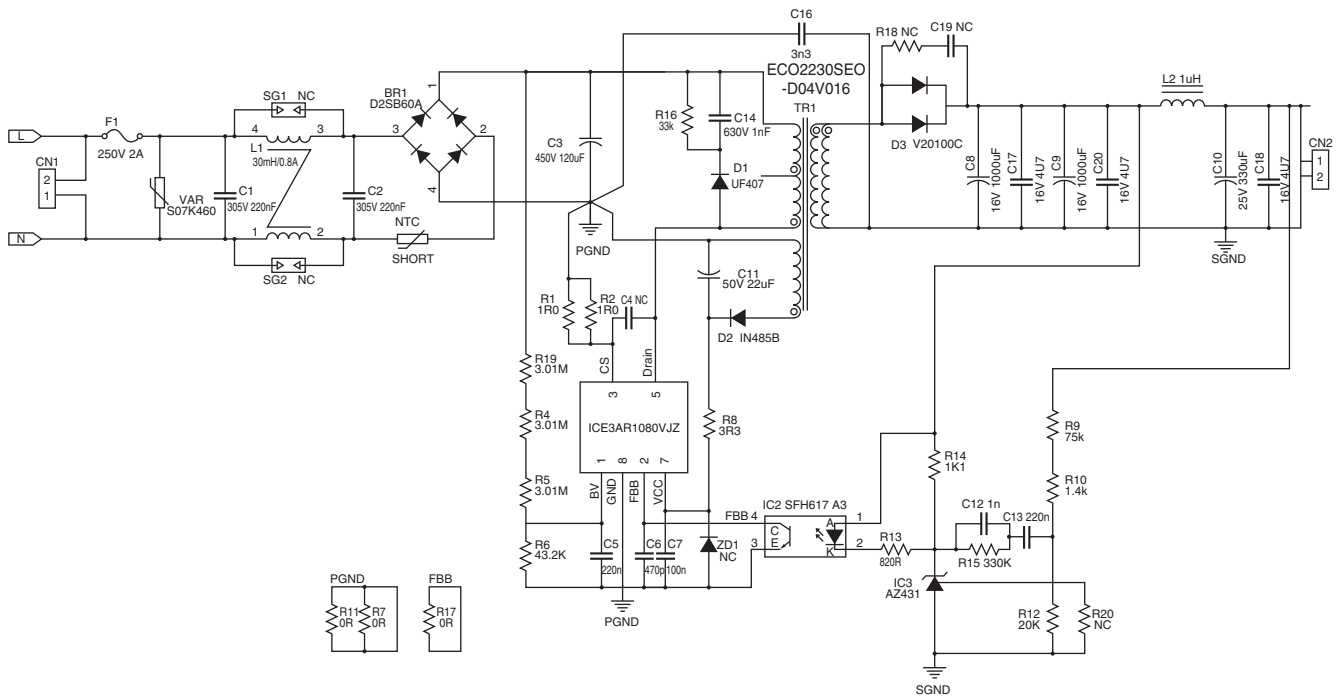

An attention matter on use

Please read this specifications before using this product by all means.

An attention matter on security

I undertake use with this product, and it is paid attention enough, and please design an attention matter safely.

Attention on a design

- When you designs a base of an electric circuit.
Please use size of the hole or pad which we recommend.
- Magnetic flux to leak out occurs. Please confirm it about influence of magnetic flux beforehand.
There is fear to cause false movement of machinery.
- In a design of a base of an electric circuit, Please consider the next contents.
In an applied safe standard.
The trans and distance with other parts
- The product is not quakeproof structure.
Accordingly please do not add vibration and a shock to it.
There is fear to lose a function.

Attention on the handling

- Please do not use it when you let a product drop.
The product produces possibility to lose a function
- Please pay attention to the pin which had it pointed keenly.
There is danger to injure.
- Please avoid the next place. The place that receives a drop of water, trash, the dust, foggy influence. The place where direct rays of the sun hits. There is fear to cause false movement of machinery.
- Please prohibit safekeeping and use at the next place. Environment to be accompanied with gas corrosion, salt, acid, alkali. There is fear to lose a function.
- When you carry the product on a base of an electric circuit.
Please do not use a metal tool. Because impossible power is added to a product.
There is fear to lose a function.

Attention

- I considered the next matter, and we designed a product.
Safe standard and power supply voltage and circuit drive condition, drive frequency and Duty ON-TIME.
By those conditions, we decided structure and the turns number.
Please avoid use in designed condition outside.
There are destruction of a circuit part and fear of ignition.
- This product considered a characteristic of a component and a self temperature rise, and it was made.
We select range of humidity as use temperature already.
Please avoid use by range more than this.
There are the damage and fear of ignition.
- Please avoid use in the environment next.
The environment that trash and the dust stick to a product. There is fear to cause a fire.
- The products listed on this specification sheet are intended for use in general electronic equipment (AV equipment, telecommunications equipment, home appliances, amusement equipment, computer equipment, personal equipment, office equipment, measurement equipment, industrial robots) under a normal operation and use condition.
- The products are not designed or warranted to meet the requirements of the applications listed below, whose performance and/or quality require a more stringent level of safety or reliability, or whose failure, malfunction or trouble could cause serious damage to society, person or property.
- If you intend to use the products in the applications listed below or if you have special requirements exceeding the range or conditions set forth in this catalog, please contact us.

- (1) Aerospace/Aviation equipment
- (2) Transportation equipment (cars, electric trains, ships, etc.)
- (3) Medical equipment
- (4) Power-generation control equipment
- (5) Atomic energy-related equipment
- (6) Seabed equipment applications
- (7) Transportation control equipment

- (8) Public information-processing equipment
- (9) Military equipment
- (10) Electric heating apparatus, burning equipment
- (11) Disaster prevention/crime prevention equipment
- (12) Safety equipment
- (13) Other applications that are not considered general-purpose applications

When designing your equipment even for general-purpose applications, you are kindly requested to take into consideration securing protection circuit/device or providing backup circuits in your equipment.