



## Certifications & Ratings

- RoHS compliant

## Application

The 612 Series LED Panel Mount Indicators are designed for a variety of applications such as:

- Main power indication
  - Remote power indication
  - Status indication
  - Maintenance and warning indication
  - Instrumentation
- ... and many more!

## Dimensions

inches [mm]

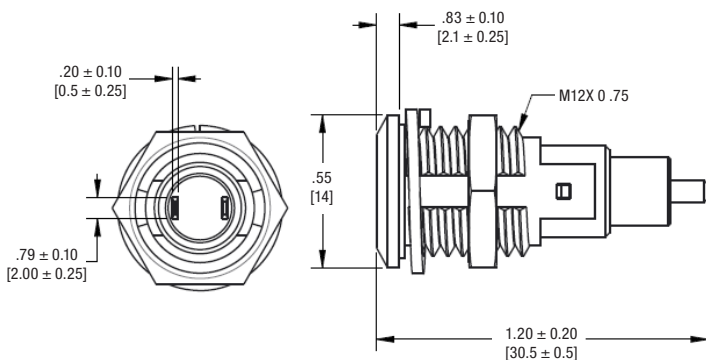

## Mechanical Information

- Mounting Hole Size:** 0.492" (12.5 mm)
- Max Panel Thickness:** 0.236" (6.0 mm)
- Mounting Torque:** 0.217 lbs/ft (3 kg/cm)

## Specifications

- Voltage Options:** 6, 12 & 24 VDC (no resistor required)
- Operating Temp:** -25 °C to +85 °C (-13 °F to +185 °F)
- Storage Temp:** -25 °C to +100 °C (-13 °F to +212 °F)
- Electrical Connection:** Solder terminals
- Housing:** Polycarbonate
- Terminals:** Copper—Nickel Plated
- Lock Washer:** Iron—Nickel Plated
- Nut:** Brass—Nickel Plated

## Ordering Information 612 Series

Part Number	Color	Voltage (V DC)	Current (mA)	Intensity Typ. (mcd)
612-3132-120F	● Red	6	15	65
612-3232-120F	● Green			110
612-3332-120F	● Yellow			80
612-3132-130F	● Red	12		65
612-3232-130F	● Green			110
612-3332-130F	● Yellow			80
612-3132-140F	● Red	24		65
612-3232-140F	● Green			110
612-3332-140F	● Yellow			80

Dialight reserves the right to make changes at any time in order to supply the best product possible. The most current version of this document will always be available at: [www.dialightsignalsandcomponents.com](http://www.dialightsignalsandcomponents.com)

**Warranty Statement:** Except for the warranty expressly provided for [herein/above/below], Dialight disclaims any and all other warranties, express or implied, including, without limitation, any warranties of merchantability, fitness for a particular purpose, title, and noninfringement.

