

## Load Switch with Level-Shift

### UM3865P SOT363

#### General Description

The UM3865P includes a p- and n-channel MOSFET in a single SOT363 package. The low on-resistance p-channel MOSFET is tailored for use as a load switch. The n-channel, with an external resistor, can be used as a level-shift to drive the p-channel load switch. The n-channel MOSFET has internal ESD protection and can be driven by logic signals as low as 1.5V. The UM3865P operates on supply lines from 1.8V to 8V, and can drive loads up to 1A.

#### Applications

- Battery Packs
- Battery-Powered Portable Equipment
- Cellular and Cordless Telephones

#### Features

- 300 mΩ Low On-Resistance
- 1.8V to 8V Input
- 1.5V to 8V Logic Level Control
- Low Profile, Small Footprint SOT363 Package
- 2000V ESD Protection on Input Switch
- Adjustable Slew-Rate

#### Pin Configurations

#### Top View

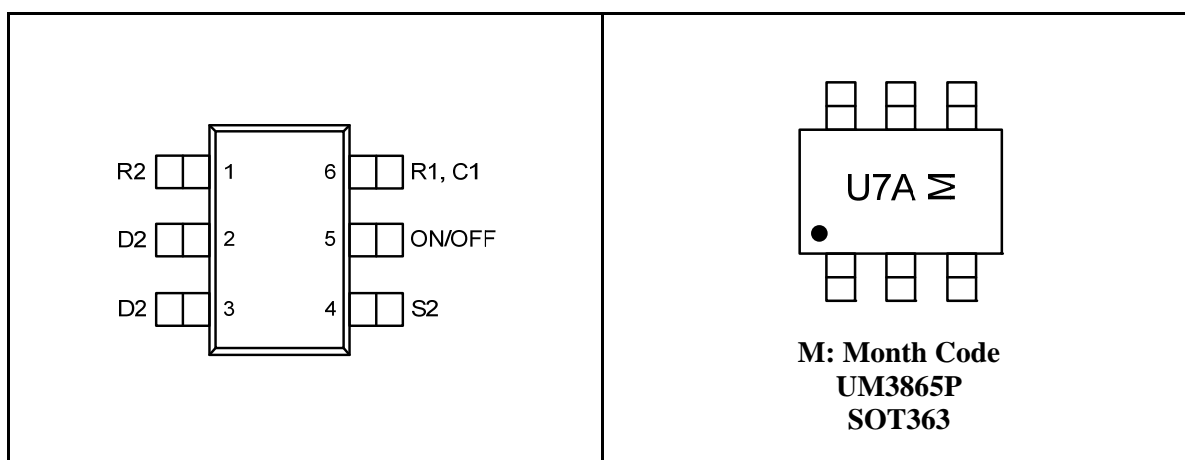

#### Ordering Information

Part Number	Packaging Type	Marking Code	Shipping Qty
UM3865P	SOT363	U7A	3000pcs/7 Inch Tape & Reel

## Typical Application Circuit

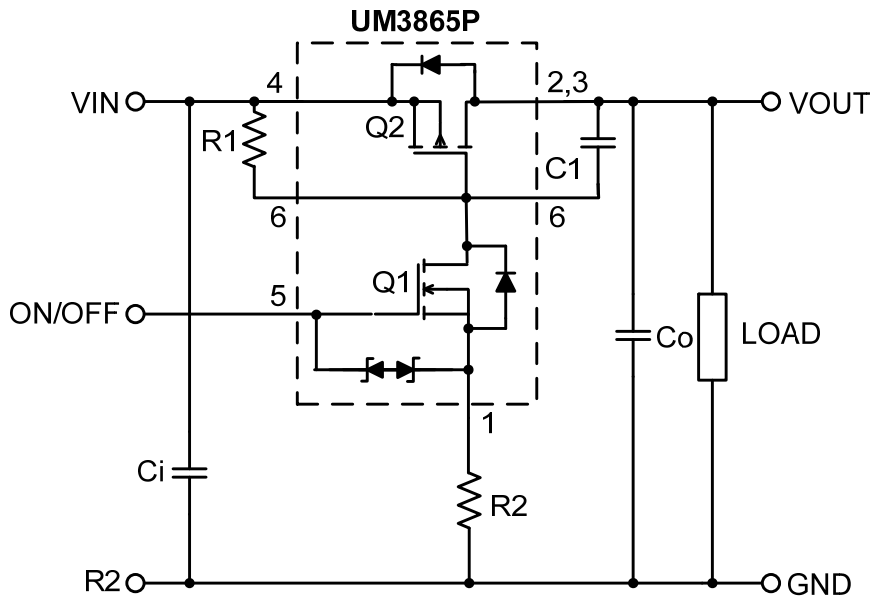

COMPONENTS		
R1	Pull-Up Resistor	Typical 20kΩ to 1MΩ*
R2	Optional Slew-Rate Control	Typical 0 to 50kΩ
C1	Optional Slew-Rate Control	Typical 1000pF

\*Minimum R1 value should be at least  $10 \times R2$  to ensure Q1 turn-on.

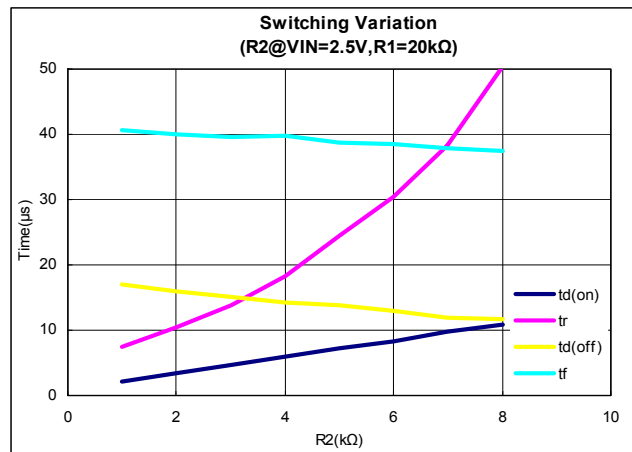

Note 1: For R2 switching variations with other VIN/R1 combinations, see Typical Characteristics.

## Absolute Maximum Ratings

Symbol	Parameter	Limit	Unit
$V_{IN}$	Input Voltage	8	V
$V_{ON/OFF}$	ON/OFF Voltage	8	
$I_L$	Continuous Load Current (Note 2, 3)	$\pm 1$	A
	Pulse Load Current (Note 3, 4)	$\pm 5$	
$I_S$	Continuous Source Current (Source-Drain Diode)	-1.0	
$P_D$	Maximum Power Dissipation	0.5	W
$T_J, T_{STG}$	Junction and Storage Temperature Range	-50 to +150	$^{\circ}C$
ESD	ESD Rating, MIL-STD-883D HBM	2000	V
$R_{\theta JA}$	Thermal Resistance, Junction-to-Ambient	250	$^{\circ}C/W$

## Electrical Characteristics ( $T_J=25^{\circ}C$ , unless otherwise noted)

Symbol	Parameter	Test Condition	Min	Typ	Max	Unit
<b>OFF Characteristics</b>						
$I_{FL}$	Reverse Leakage Current	$V_{IN}=8V, V_{ON/OFF}=0V$			1	$\mu A$
$V_{SD}$	Diode Forward Voltage	$I_S=-1A$		-0.73	-1	V
<b>ON Characteristics</b>						
$V_{IN}$	Input Voltage Range		1.8		8	V
$R_{DS(ON)}$	Static Drain-to-Source On-Resistance	$V_{ON/OFF}=1.5V, V_{IN}=4.5V, I_D=1.0A$		0.300	0.350	$\Omega$
		$V_{ON/OFF}=1.5V, V_{IN}=2.5V, I_D=1.0A$		0.400	0.450	
$I_{D(on)}$	On-State (P-Channel) Drain Current	$V_{IN-OUT} \leq 0.2V, V_{IN}=5V, V_{ON/OFF}=1.5V$	0.7			A
		$V_{IN-OUT} \leq 0.3V, V_{IN}=3V, V_{ON/OFF}=1.5V$	0.8			

Note 2: Surface Mounted on FR4 Board.

Note 3:  $V_{IN}=8V, V_{ON/OFF}=8V, T_A=25^{\circ}C$ .

Note 4: Pulse test: Pulse Width  $\leq 300\mu s$ , duty cycle  $\leq 2\%$ .

## Typical Characteristics ( $T_J=25^\circ\text{C}$ , unless otherwise noted)

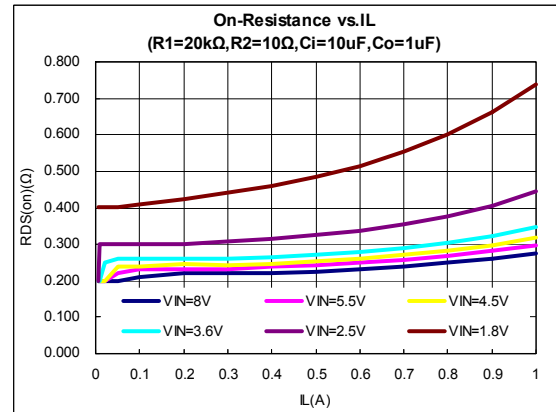
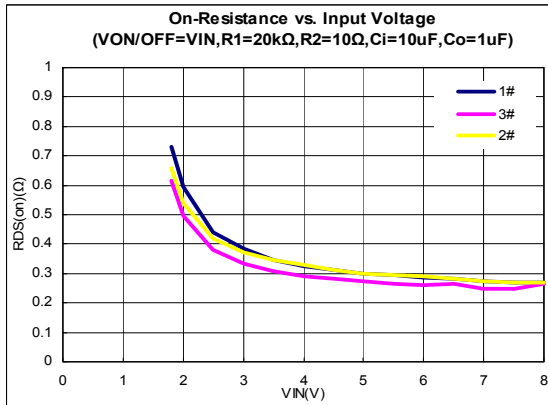
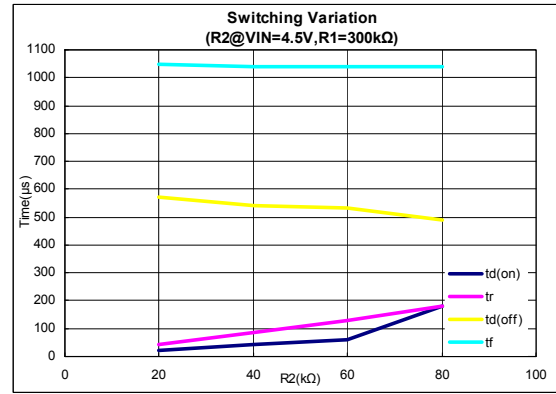
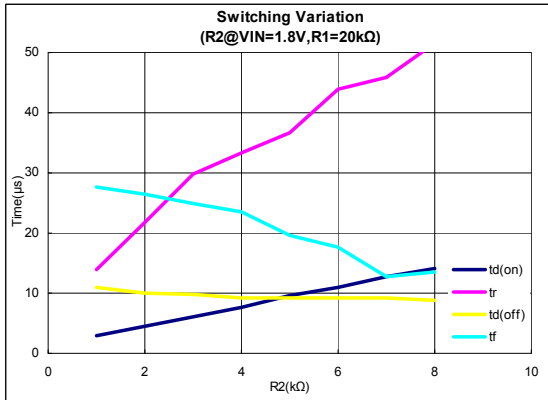
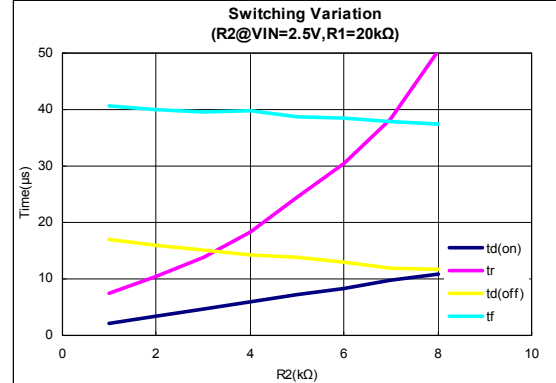
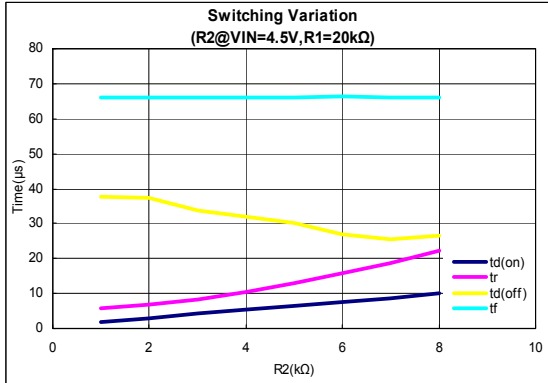

## Package Information

### UM3865P SOT363

#### Outline Drawing

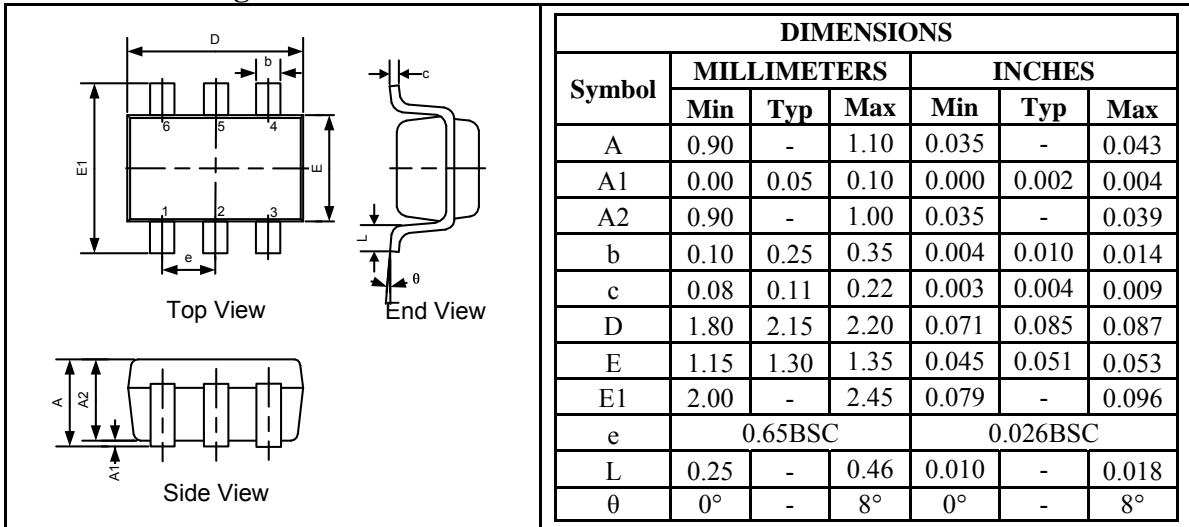

#### Land Pattern

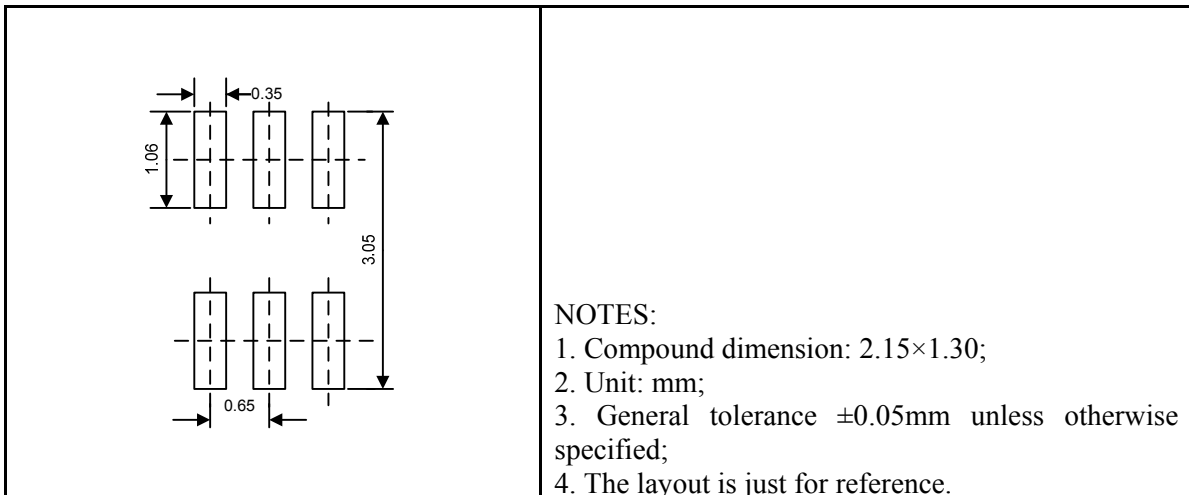

#### Tape and Reel Orientation

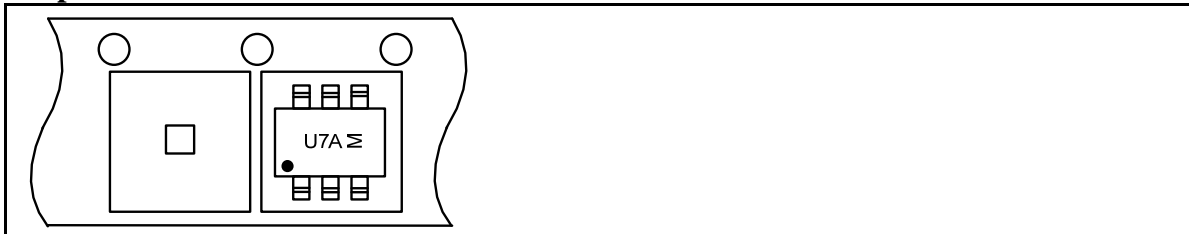

---

## **GREEN COMPLIANCE**

Union Semiconductor is committed to environmental excellence in all aspects of its operations including meeting or exceeding regulatory requirements with respect to the use of hazardous substances. Numerous successful programs have been implemented to reduce the use of hazardous substances and/or emissions.

All Union components are compliant with the RoHS directive, which helps to support customers in their compliance with environmental directives. For more green compliance information, please visit:

[http://www.union-ic.com/index.aspx?cat\\_code=RoHSDeclaration](http://www.union-ic.com/index.aspx?cat_code=RoHSDeclaration)

## **IMPORTANT NOTICE**

The information in this document has been carefully reviewed and is believed to be accurate. Nonetheless, this document is subject to change without notice. Union assumes no responsibility for any inaccuracies that may be contained in this document, and makes no commitment to update or to keep current the contained information, or to notify a person or organization of any update. Union reserves the right to make changes, at any time, in order to improve reliability, function or design and to attempt to supply the best product possible.



Union Semiconductor, Inc

Add: Unit 606, No.570 Shengxia Road, Shanghai 201210

Tel: 021-51093966

Fax: 021-51026018

Website: [www.union-ic.com](http://www.union-ic.com)