

Data sheet

Keystone wall outlet flush mounted 1 port unequipped pure white

Page 1/6

P/N
130B20D11002KE
EAN 4250184157724
2023/05/31
Version: T

Illustrations



Dimensional drawing

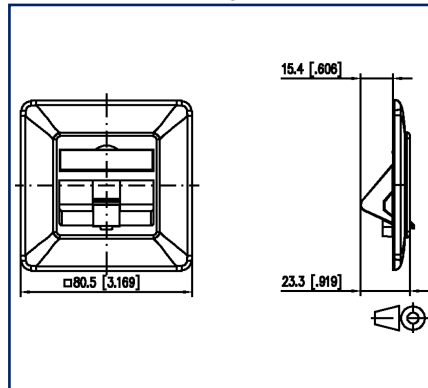

Drill pattern

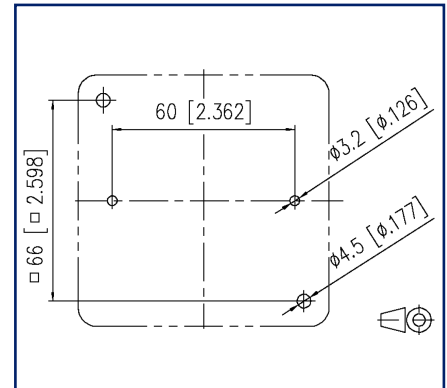

See enlarged drawings at the end of document

Product specification

- flush-mounted termination unit for individual modules in Keystone design
- module plug direction 45° downwards
- strain relief on the module
- with label window for enclosed identification labels
- label sheet 209 x 294 mm see accessory
- integrated dust protection covers (also colored versions available)
- cover parts in pure white RAL 9010, structured surface with matt finish
- compatible with design central units of switch lines
- Variants: 1 port, 2 ports, 3 ports

Keystone wall outlet flush mounted 1 port unequipped pure white

P/N
130B20D11002KE
EAN 4250184157724
2023/05/31
Version: T

Technical Data

General Data

Fields of application	office areas
Mechanical measurement according to MICE	M1
Ingress measurement according to MICE	I1
Climatic measurement according to MICE	C1
Electromagnetic measurement according to MICE	E3
Design	wall outlet
Mounting style	UP
Color	Pure white RAL 9010
Dimensions	
Dimension (L x W x H)	23.3 mm x 80.5 mm x 80.5 mm
Dimension (L x W x H)	0.917 in. x 3.169 in. x 3.169 in.
Labeling option	label window with identification label
Marking option	by dust protection

Connections/interfaces

Number of ports interface 2	1
Number of ports interface 2 equipped	0
Number of ports with dust protection interface 2	1
Module plug-in direction	45° downwards

Mechanical data

Cut-out	Keystone
strain relief	attached to module

Materials and material properties

Material - Supporting frame	GD-Zn (zinc die-cast)
Material - Cover part(s)	ABS
Material - Label window	ABS, transparent
Material - Dust protection	ABS
Halogen free	yes
RoHS	compliant

P | Cabling

Data sheet

Page 3/6

Keystone wall outlet flush mounted 1 port unequipped pure white

P/N
130B20D11002KE
EAN 4250184157724
2023/05/31
Version: T

Technical Data

Standards/Regulations

Cover plates for installation devices 1	DIN 49075-1:1989-10
Cover plates for installation devices 2	DIN 49075-2:1989-10

Classifications

ETIM 5.0	EC001264
ETIM 6.0	EC001264
ETIM 7.0	EC001264
ETIM 8.0	EC001264
ETIM 9.0	EC001264

Packing details

Type of packaging	10 pc(s) / box
Packaging unit - Weight (gram)	1110 g
Packaging unit - Weight (pound)	2.45 lb
Packaging dimension	240 mm x 170 mm x 140 mm
Packaging dimension	9.449 in. x 6.693 in. x 5.512 in.

Keystone wall outlet flush mounted 1 port unequipped pure white

P/N
130B20D11002KE
EAN 4250184157724
2023/05/31
Version: T

Accessories

P/N	Designation
130829-02-I	Surface mount frame 85 x 85 mm - Single, pure white
130829-4302-I	Surface mount frame 85 x 85 x 43 mm - single, pure white
1308895010-I	T-Slot mounting bracket for wall outlets - horizontal mounting without 50 mm, separation cup
1308895011-I	T-Slot mounting bracket for wall outlets - horizontal mounting 50 mm, with separation cup
1308895020-I	DIN Rail mounting bracket for wall outlets - horizontal mounting 50 mm, without separation cup
1308895021-I	DIN Rail mounting bracket for wall outlets - horizontal mounting 50 mm, with separation cup
1308895040-I	T-Slot mounting bracket for wall outlets - vertical mounting 50 mm, without separation cup
1308895041-I	T-Slot mounting bracket for wall outlets - vertical mounting 50 mm, with separation cup
1308895220-I	DIN rail mounting bracket for wall outlets - horizontal mounting 52 mm, without separation cup
1308895221-I	DIN rail mounting bracket for wall outlets - horizontal mounting 52 mm, with separation cup
1308895510-I	T-Slot mounting bracket for wall outlets - horizontal mounting 55 mm, without separation cup
1308895511-I	T-Slot mounting bracket for wall outlets - horizontal mounting 55 mm, with separation cup
1308895520-I	DIN rail mounting bracket for wall outlets - horizontal mounting 55 mm, without separation cup
1308895521-I	DIN rail mounting bracket for wall outlets - horizontal mounting 55 mm, with separation cup
1308895540-I	T-Slot mounting bracket for wall outlets - vertical mounting 55 mm, without separation cup
1308895541-I	T-Slot mounting bracket for wall outlets - vertical mounting 55 mm, with separation cup
130889ADTK-I	Mounting bracket ADTK for OBO
130889ADTSA-I	Mounting bracket ADTSA for OBO
130889FKH-I	Mounting bracket FR for Kleinhuis
130889FNI-I	Mounting bracket FR for Niedax
130889FTE-I	Mounting bracket FR for Tehalit
820394-0105-I	Dust protection covers for wall outlets yellow
820394-0106-I	Dust protection covers for wall outlets blue
820394-0107-I	Dust protection covers for wall outlets green

P | Cabling

Data sheet

Page 5/6

Keystone wall outlet flush mounted 1 port unequipped pure white

P/N

130B20D11002KE

EAN 4250184157724

2023/05/31

Version: T

Accessories

820394-0108-I	Dust protection covers for wall outlets red
820395-0102-I	Cover plate 80 x 80 mm, pure white, module
899650-01	Label sheet for wall outlets



P | Cabling

Data sheet

Page 6/6

Keystone wall outlet flush mounted 1 port unequipped pure white

P/N

130B20D11002KE

EAN 4250184157724

2023/05/31

Version: T

Illustrations

Dimensional drawing

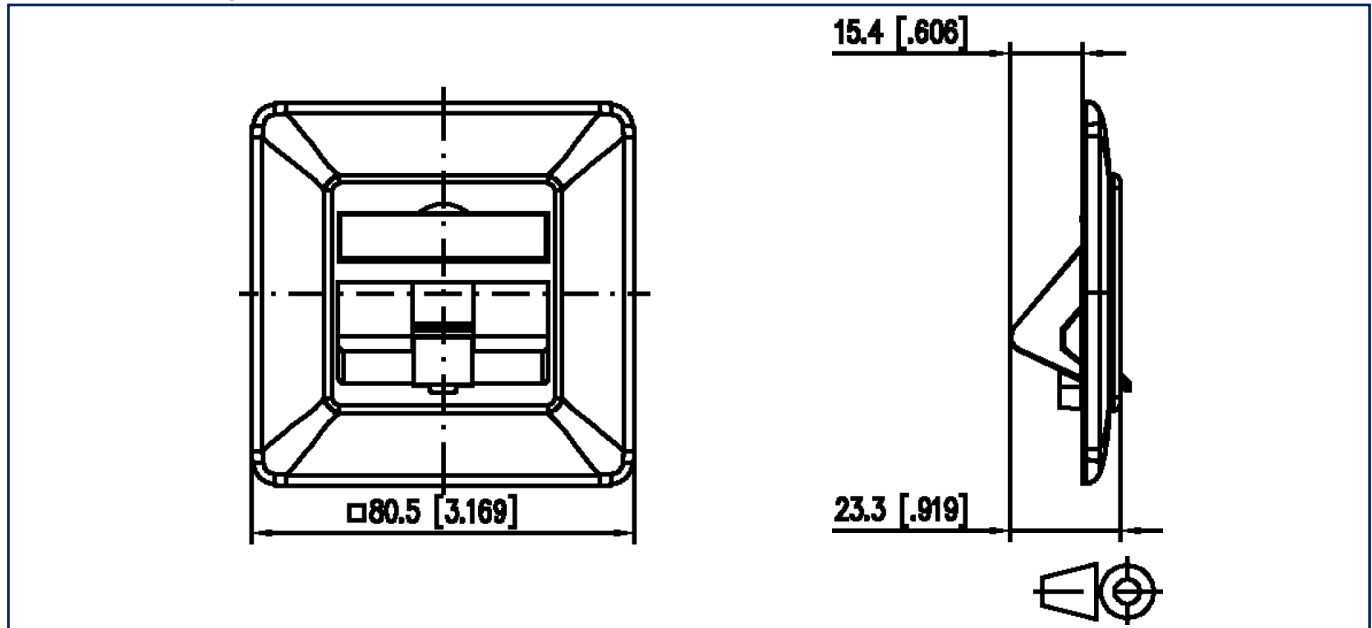

Drill pattern

