

Programmable Multi-Channel Driver PMD-35D-LU

SLP-DUA435D1US



Key Features

- Programmable, adjustable constant output current which can be adjusted to match LED module requirements
- Device Type 8 (DALI), PMD supports IEC 62386-209 standard command and represents the color temperature of a light Source

Basic Features

Series.	Part Number	Max. Power	Function	Input Voltage	Output Voltage	Output Current	Certification
PMD-35D-LU	SLP-DUA435D1US	35W	DALI	120~277Vac	10~50Vdc	0.35~1.4A	cUL

- Certification : UL8750, UL Class2 Power, 47 CFR Part15 Subpart B
- Protections : Short Circuit, Over Temperature, Open Lamp, Over Voltage, Over load
- ta Range : -20 ~ +50 °C
- Expected Lifetime : 50,000 hours at tc = 70 °C

PMD Series

Series	Part Number	Max. Power	Function	Input Voltage	Output Voltage	Output Current	Certification
PMD-75C-LU	SLP-DUA47531WW	75W	0-10V, DALI	120~277Vac	10~50Vdc	0.35~1.4A	cUL, CE
PMD-75A-L	SLP-DUA47501US	75W	0-10V	120~277Vac	10~50Vdc	0.35~1.4A	cUL
PMD-75D-L	SLP-D2A475D1EU	75W	DALI	220~240Vac	10~50Vdc	0.35~1.4A	CE, ENEC
PMD-75D-LU	SLP-DUA475D1US	75W	DALI	120~277Vac	10~50Vdc	0.35~1.4A	cUL
PMD-55A-L	SLP-DUA45501US	55W	0-10V	120~277Vac	10~50Vdc	0.35~1.4A	cUL
PMD-55D-L	SLP-D2A455D1EU	55W	DALI	220~240Vac	10~50Vdc	0.35~1.4A	CE, ENEC
PMD-55D-LU	SLP-DUA455D1US	55W	DALI	120~277Vac	10~50Vdc	0.35~1.4A	cUL
PMD-55A-S	SLP-DUA4550AUS	55W	0-10V	120~277Vac	10~50Vdc	0.35~1.4A	cUL
PMD-35A-L	SLP-DUA43501US	35W	0-10V	120~277Vac	10~50Vdc	0.35~1.4A	cUL
PMD-35D-L	SLP-D2A435D1EU	35W	DALI	220~240Vac	10~50Vdc	0.35~1.4A	CE, ENEC
PMD-35D-LU	SLP-DUA435D1US	35W	DALI	120~277Vac	10~50Vdc	0.35~1.4A	cUL
PMD-35A-S	SLP-DUA4350AUS	35W	0-10V	120~277Vac	10~50Vdc	0.35~1.4A	cUL
PMD-25A-S	SLP-DUA0250AUS	25W	0-10V	120~277Vac	10~50Vdc	0.35~1.0A	cUL
PMD-25D-SU	SLP-DUA025DAWW	25W	DALI	120~277Vac	10~50Vdc	0.35~1.0A	cUL, CE, ENEC

Table of Contents

1.	Electrical Specification	-----	4
2.	Enclosure	-----	5
3.	Label	-----	5
4.	Connector	-----	6
5.	Packing	-----	6
6.	Protection	-----	7
7.	Operating Window	-----	8
8.	Performance	-----	8
9.	DALI Command List	-----	10
10.	Precautions	-----	13

1. Electrical Specification

Article	Symbol	Specification			Unit	Note
		Min.	Typ.	Max.		
INPUT SPECIFICATIONS						
Nominal Voltage	V _{in}	120		277	Vac	Full input range
Voltage Range		108		305	Vac	
Nominal Frequency	f _{in}	50		60	Hz	
Frequency Range		47		63	Hz	
Input Current	I _{in}			0.4	A	@ 120Vac
Input Current	I _{in}			0.18	A	@ 277Vac
Total Harmonic Distortion	THD			20	%	@ full load, 120-277 Vac
Power Factor	PF	0.9			-	@ full load, 120-277Vac
Efficiency	H	83	85		%	@ full load, 120-277 Vac,
Protection Class			I		-	PE can be connected to either terminal or housing
Inrush Current				20	A _{pk}	t _{width} = Typ. 300 μs @ 50% I _{peak})
OUTPUT SPECIFICATIONS						
Nominal Voltage	V _o	10		50	Vdc	See graph
Nominal Current	I _o	0.35		1.4	A	2channel ±5 % tolerance (@ max current)
Current Ripple				30	%	Output current ± 30%
Nominal Power	P _o			35	W	Output wattage
Auxiliary Power Voltage			24		V	For nIO Supply Power
Auxiliary Power Current				100	mA	For nIO Supply power
Turn on delay time	T _d		1.0		s	AC on 90%
Dimming SPECIFICATIONS						
Control 1			DALI			DALI protocol
Control 1 Range			1-100		%	
Dimming Technique			PWM			
Galvanic Isolation			Basic / Double			Basic: DALI to primary-earth Double: DALI to secondary
Standby Power				0.5	W	Dimming Off

Article	Symbol	Specification			Unit	Note
		Min.	Typ.	Max.		
ENVIRONMENTAL SPECIFICATIONS						
Ambient Temperature	t_a	-20		50	°C	
Max.Case Temperature	t_c			79	°C	Measured at t_c point as indicated on the product label
Expected Lifetime		50,000			h	$t_c = 70$ °C , full load
Storage Temperature	t_s	-20		85	°C	Cool down before operating
Relative Humidity		20		95	%	Not condensing
Surge Transient Protection	L / N			±2	kV	According to EN 61547
	LN / GND			±4	kV	
IP Rating			20		-	Suitable for indoor environment
Dimensions	L x W x H		270 x 33 x 25		mm	
Net Weight			273		g	± 10%

2. Enclosure

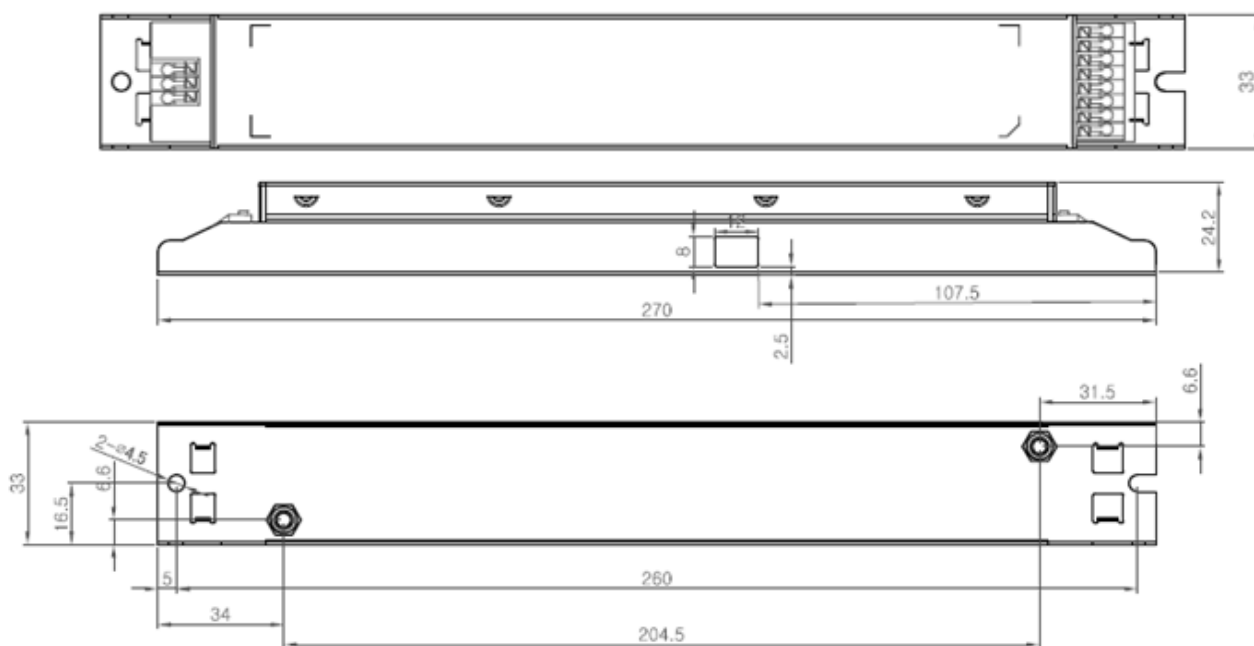

3. Label

SAMSUNG	PMD(Programmable Multichannel Driver) SLP-DUA435D1US(Only for LED Module)	UL US E470825 Tc.	wire preparation push in 0.2 – 0.75□	S/N	Block Connection													
	Vin : 120 – 277 V~ Vout : 10 – 50V=== Iin : 0.4A Iout : 0.35 – 1.4A Freq : 50/60Hz Vaux : 24V === Iaux : 0.1A PF : > 0.90C Pout : 25 – 35W					Made in Korea <input type="checkbox"/> Made in China <input type="checkbox"/> GROUNDING Driver case must be grounded	<table border="1"> <tr><td>Live</td><td>LED1+</td></tr> <tr><td>NC</td><td>LED1-</td></tr> <tr><td>Neutral</td><td>LED2+</td></tr> <tr><td>NC</td><td>LED2-</td></tr> <tr><td>DA</td><td>24V</td></tr> <tr><td>DA</td><td>GND</td></tr> <tr><td>NC</td><td></td></tr> <tr><td>P.E</td><td></td></tr> </table>	Live	LED1+	NC	LED1-	Neutral	LED2+	NC	LED2-	DA	24V	DA
Live	LED1+																	
NC	LED1-																	
Neutral	LED2+																	
NC	LED2-																	
DA	24V																	
DA	GND																	
NC																		
P.E																		
		DALI	8.5...9.5mm		Current Setting													

- Box Label

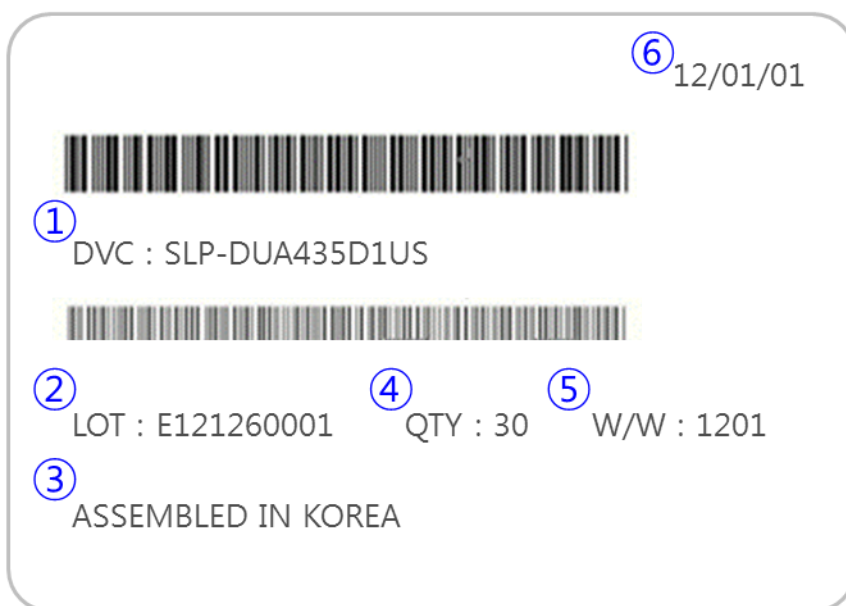

- ① Model Code
- ② Lot No.
- ③ Origin
- ④ Packing Quantity
- ⑤ Date of Manufacture (Weekly)
- ⑥ Date of Manufacture (Daily)

6. Protection

Items	Symbol	Condition	Function
Over Temperature Protection	OTP	Exceeds factory preset Temp.	Current decreases (Auto Recovery)
Short Circuit Protection	SCP	Vin = Rated Voltage, LED short	No Output (Auto Recovery)
Open Lamp Protection	OLP	Vin = Rated Voltage, LED open	Vout = 60V Clamp (Auto Recovery)
Over Voltage Protection	OVP	Vin = Rated Voltage, F/B Open or Short	Vout = 60V Clamp (Auto Recovery)
Over load Protection	OLP	Wattage exceeds 35W	Current decrease(Auto Recovery)

7. Operating Window

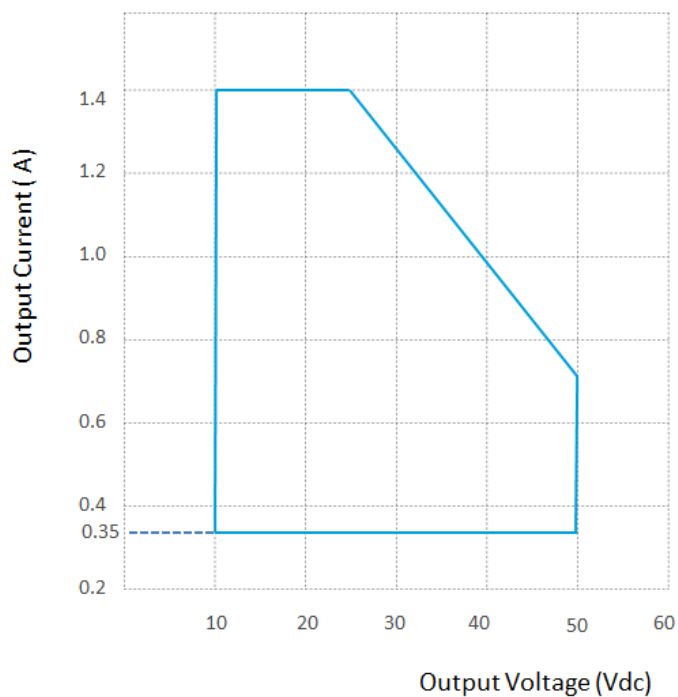

8. Performance

- Tested with connected LED load , Programmed for 1,400mA and at 25 °c ambient temperature. The measurements below 35W were performed by dimming the light output

- Efficiency

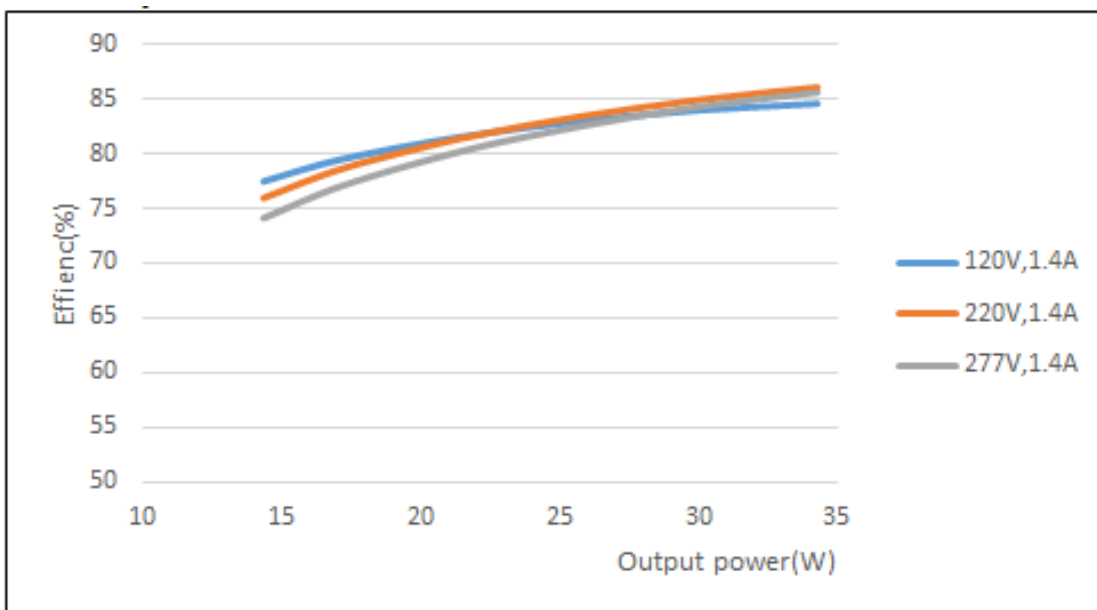

- Power Factor

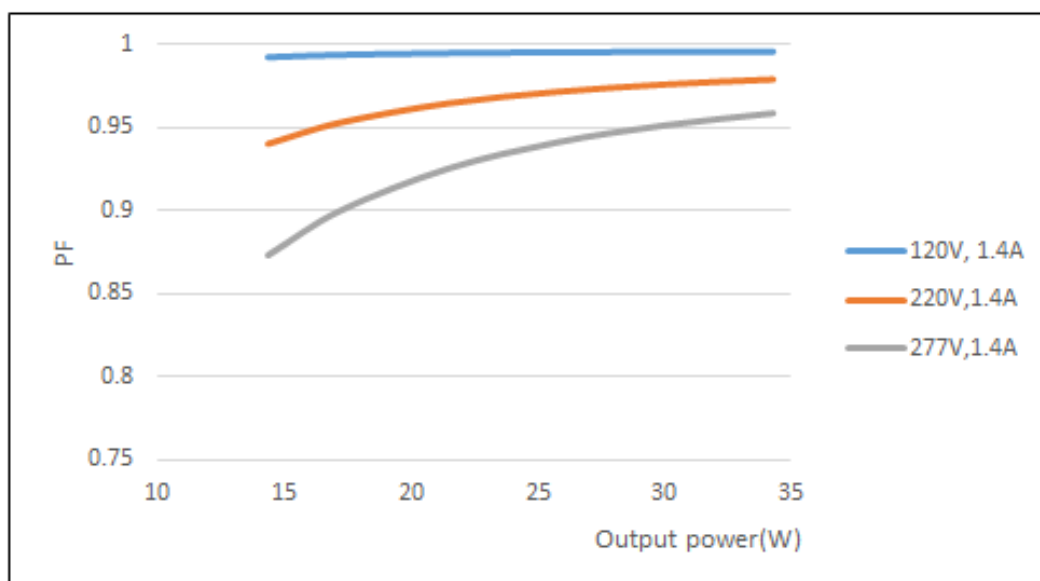

- Total Harmonic Distortion

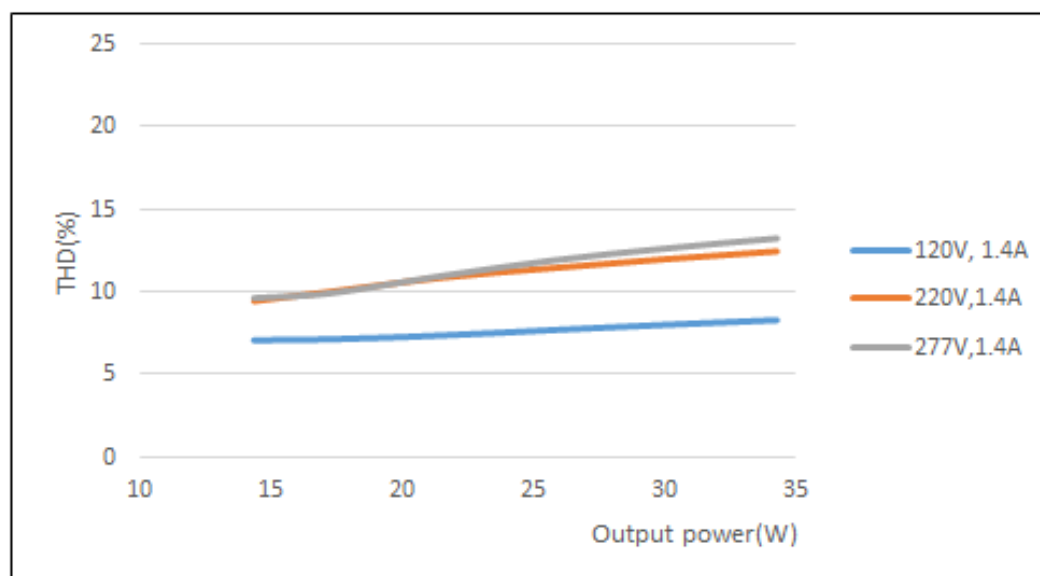

9. DALI Command List

- IEC 62386 – 102

Number	Code	Name
–	YAAA AAA0 XXXX XXXX	DIRECT ARC POWER CONTROL
0	YAAA AAA1 0000 0000	OFF
1	YAAA AAA1 0000 0001	UP
2	YAAA AAA1 0000 0010	DOWN
3	YAAA AAA1 0000 0011	STEP UP
4	YAAA AAA1 0000 0100	STEP DOWN
5	YAAA AAA1 0000 0101	RECALL MAX LEVEL
6	YAAA AAA1 0000 0110	RECALL MIN LEVEL
7	YAAA AAA1 0000 0111	STEP DOWN AND OFF
8	YAAA AAA1 0000 1000	ON AND STEP UP
9	YAAA AAA1 0000 1001	ENABLE DAPC SEQUENCE
16 – 31	YAAA AAA1 0001 XXXX	GO TO SCENE
32	YAAA AAA1 0010 0000	RESET
33	YAAA AAA1 0010 0001	STORE ACTUAL LEVEL IN THE DTR
42	YAAA AAA1 0010 1010	STORE THE DTR AS MAX LEVEL
43	YAAA AAA1 0010 1011	STORE THE DTR AS MIN LEVEL
44	YAAA AAA1 0010 1100	STORE THE DTR AS SYSTEM FAILURE LEVEL
45	YAAA AAA1 0010 1101	STORE THE DTR AS POWER ON LEVEL
46	YAAA AAA1 0010 1110	STORE THE DTR AS FADE TIME
47	YAAA AAA1 0010 1111	STORE THE DTR AS FADE RATE
64 – 79	YAAA AAA1 0100 XXXX	STORE THE DTR AS SCENE
80 – 95	YAAA AAA1 0101 XXXX	REMOVE FROM SCENE
96 – 111	YAAA AAA1 0110 XXXX	ADD TO GROUP
112 – 127	YAAA AAA1 0111 XXXX	REMOVE FROM GROUP
128	YAAA AAA1 1000 0000	STORE DTR AS SHORT ADDRESS
129	YAAA AAA1 1000 0001	ENABLE WRITE MEMORY
144	YAAA AAA1 1001 0000	QUERY STATUS
145	YAAA AAA1 1001 0001	QUERY CONTROL GEAR
146	YAAA AAA1 1001 0010	QUERY LAMP FAILURE
147	YAAA AAA1 1001 0011	QUERY LAMP POWER ON
148	YAAA AAA1 1001 0100	QUERY LIMIT ERROR
149	YAAA AAA1 1001 0101	QUERY RESET STATE
150	YAAA AAA1 1001 0110	QUERY MISSING SHORT ADDRESS
151	YAAA AAA1 1001 0111	QUERY VERSION NUMBER
152	YAAA AAA1 1001 1000	QUERY CONTENT DTR
153	YAAA AAA1 1001 1001	QUERY DEVICE TYPE
154	YAAA AAA1 1001 1010	QUERY PHYSICAL MINIMUM LEVEL
155	YAAA AAA1 1001 1011	QUERY POWER FAILURE
156	YAAA AAA1 1001 1100	QUERY CONTENT DTR1
157	YAAA AAA1 1001 1101	QUERY CONTENT DTR2
160	YAAA AAA1 1010 0000	QUERY ACTUAL LEVEL
161	YAAA AAA1 1010 0001	QUERY MAX LEVEL
162	YAAA AAA1 1010 0010	QUERY MIN LEVEL

163	YAAA AAA1 1010 0011	QUERY POWER ON LEVEL
164	YAAA AAA1 1010 0100	QUERY SYSTEM FAILURE LEVEL
165	YAAA AAA1 1010 0101	QUERY FADE TIME/FADE RATE
176 – 191	YAAA AAA1 1011 XXXX	QUERY SCENE LEVEL (SCENES 0-15)
192	YAAA AAA1 1100 0000	QUERY GROUPS 0-7
193	YAAA AAA1 1100 0001	QUERY GROUPS 8-15
194	YAAA AAA1 1100 0010	QUERY RANDOM ADDRESS (H)
195	YAAA AAA1 1100 0011	QUERY RANDOM ADDRESS (M)
196	YAAA AAA1 1100 0100	QUERY RANDOM ADDRESS (L)
197	YAAA AAA1 1100 0101	READ MEMORY LOCATION
255	YAAA AAA1 1111 1111	QUERY EXTENDED VERSION NUMBER
256	1010 0001 0000 0000	TERMINATE
257	1010 0011 XXXX XXXX	DATA TRANSFER REGISTER (DTR)
258	1010 0101 XXXX XXXX	INITIALISE
259	1010 0111 0000 0000	RANDOMISE
260	1010 1001 0000 0000	COMPARE
261	1010 1011 0000 0000	WITHDRAW
264	1011 0001 HHHH HHHH	SEARCHADDRH
265	1011 0011 MMMM MMMM	SEARCHADDRM
266	1011 0101 LLLL LLLL	SEARCHADDRL
267	1011 0111 OAAA AAA1	PROGRAM SHORT ADDRESS
268	1011 1001 OAAA AAA1	VERIFY SHORT ADDRESS
269	1011 1011 0000 0000	QUERY SHORT ADDRESS
270	1011 1101 0000 0000	PHYSICAL SELECTION
272	1100 0001 XXXX XXXX	ENABLE DEVICE TYPE X
273	1100 0011 XXXX XXXX	DATA TRANSFER REGISTER 1 (DTR1)
274	1100 0101 XXXX XXXX	DATA TRANSFER REGISTER 2 (DTR2)
275	1100 0111 XXXX XXXX	WRITE MEMORY LOCATION

- IEC 62386 – 207

Number	Code	Name
227	YAAA AAA1 1110 0011	SELECT DIMMING CURVE
228	YAAA AAA1 1110 0100	STORE DTR AS FAST FADE TIME
237	YAAA AAA1 1110 1101	QUERY GEAR TYPE
238	YAAA AAA1 1110 1110	QUERY DIMMING CURVE
239	YAAA AAA1 1110 1111	QUERY POSSIBLE OPERATING MODES
240	YAAA AAA1 1111 0000	QUERY FEATURES
241	YAAA AAA1 1111 0001	QUERY FAILURE STATUS
252	YAAA AAA1 1111 1100	QUERY OPERATING MODE
253	YAAA AAA1 1111 1101	QUERY FAST FADE TIME
254	YAAA AAA1 1111 1110	QUERY MIN FAST FADE TIME
272	1100 0001 0000 0110	ENABLE DEVICE TYPE 6

- IEC 62386 – 209

- o Color type : color temperature Tc

Number	Code	Name
226	YAAA AAA1 1110 0010	ACTIVATE
231	YAAA AAA1 1110 0111	SET TEMPORARY COLOUR TEMPERATURE TC
232	YAAA AAA1 1110 1000	COLOUR TEMPERATURE TC STEP COOLER
233	YAAA AAA1 1110 1001	COLOUR TEMPERATURE TC STEP WARMER
238	YAAA AAA1 1110 1110	COPY REPORT TO TEMPORARY
242	YAAA AAA1 1111 0010	STORE COLOUR TEMPERATURE TC LIMIT
243	YAAA AAA1 1111 0011	STORE GEAR FEATURES/STATUS
247	YAAA AAA1 1111 0111	QUERY GEAR FEATURES/STATUS
248	YAAA AAA1 1111 1000	QUERY COLOUR STATUS
249	YAAA AAA1 1111 1001	QUERY COLOUR TYPE FEATURES
250	YAAA AAA1 1111 1010	QUERY COLOUR VALUE
255	YAAA AAA1 1111 1111	QUERY EXTENDED VERSION NUMBER

10. Precaution

- To prevent the LED Driver from any defect, please handle and store it with care
 - Do not drop or give shock
 - Do not store in very humid location or at extreme temperature
 - Do not open or disassemble the product
- Static electricity or surge voltage may damage the components inside LED Driver, as such please observe proper anti-electrostatic working process
 - People handling the Driver should be well grounded (e.g. using ESD wrist band) and wear anti-static working clothes and gloves
 - All related devices and instruments in the production line should be well grounded (e.g. working table, measuring equipment, assembly jigs)
- Incorrect installation of the LED driver can cause irreparable damage to the LED driver and the connected LEDs. Pay attention when connecting the LEDs: polarity reversal results in damages the LED driver
 - Observe the correct polarity of output terminal : Please refer to the connection diagram as below

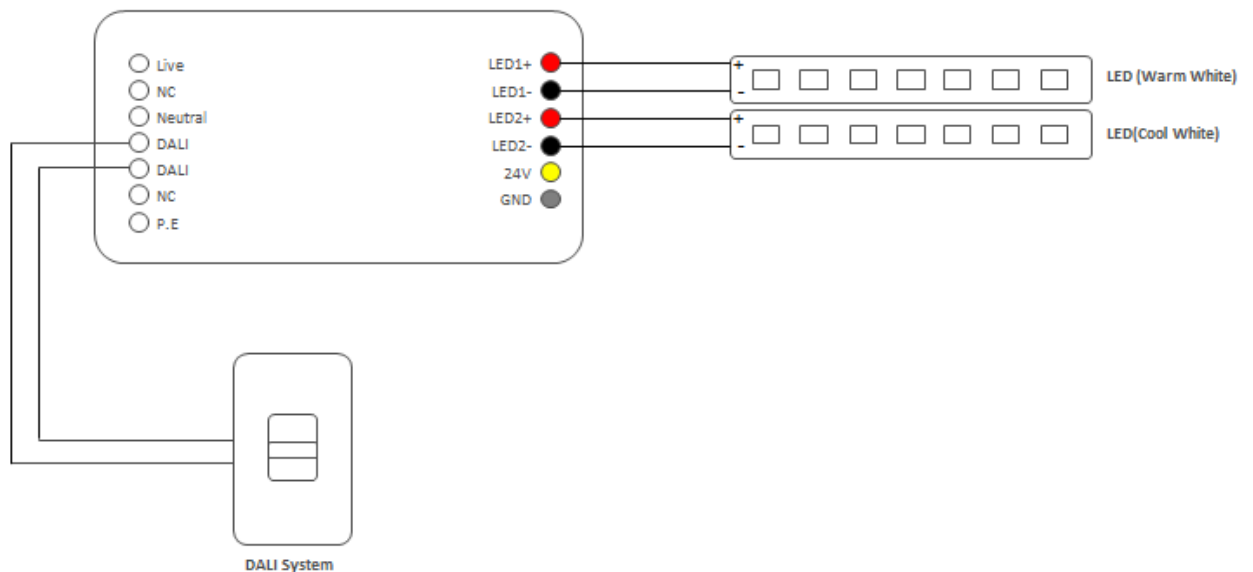

- Avoid input voltage exceeds the maximum rating, which will cause damage to the circuit and result in malfunction
- Specifications are subject to change without notice
- The LED output current is cut off whenever the LED driver detects a short circuit

Legal and additional information.

About Samsung Electronics Co., Ltd.

Samsung Electronics Co., Ltd. inspires the world and shapes the future with transformative ideas and technologies that redefine the worlds of TVs, smartphones, wearable devices, tablets, cameras, digital appliances, printers, medical equipment, network systems, and semiconductor and LED solutions. We are also leading in the Internet of Things space with the open platform SmartThings, our broad range of smart devices, and through proactive cross-industry collaboration. We employ 319,000 people across 84 countries with annual sales of US \$196 billion. To discover more, and for the latest news, feature articles and press material, please visit the Samsung Newsroom at news.samsung.com.

Copyright © 2015 Samsung Electronics Co., Ltd. All rights reserved.
Samsung is a registered trademark of Samsung Electronics Co., Ltd.
Specifications and designs are subject to change without notice. Non-metric weights and measurements are approximate. All data were deemed correct at time of creation. Samsung is not liable for errors or omissions. All brand, product, service names and logos are trademarks and/or registered trademarks of their respective owners and are hereby recognized and acknowledged.

Samsung Electronics Co., Ltd.
95, Samsung 2-ro
Giheung-gu
Yongin-si, Gyeonggi-do, 446-711
KOREA

www.samsungled.com

SAMSUNG