

Middle Power LED Series  
3030

LM302Z  
CRI 80

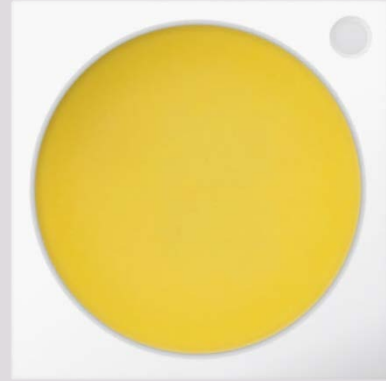

#### Features & Benefits

- 0.3 W class middle power LED
- EMC resin for high reliability
- Standard form factor for design flexibility (3.0 × 3.0 mm)



## Table of Contents

1.	Characteristics	-----	3
2.	Product Code Information	-----	4
3.	Typical Characteristics Graphs	-----	12
4.	Outline Drawing & Dimension	-----	14
5.	Reliability Test Items & Conditions	-----	15
6.	Soldering Conditions	-----	16
7.	Tape & Reel	-----	17
8.	Label Structure	-----	19
9.	Packing Structure	-----	20
10.	Precautions in Handling & Use	-----	23

## 1. Characteristics

### a) Absolute Maximum Rating

Item	Symbol	Rating	Unit	Condition
Ambient / Operating Temperature	$T_a$	-40 ~ +85	°C	-
Storage Temperature	$T_{stg}$	-40 ~ +100	°C	-
LED Junction Temperature	$T_j$	125	°C	-
Forward Current	$I_F$	200	mA	-
Pulse Forward Current	$I_{FP}$	400	mA	Duty 1/10, pulse width 10 ms
Assembly Process Temperature	-	260 <10	°C s	-
ESD (HBM)	-	5	kV	-

### b) Electro-optical Characteristics ( $I_F = 150 \text{ mA}$ , $T_s = 25 \text{ °C}$ )

Item	Nominal CCT (K)	Rank	Bin	Min.	Typ.	Max.	Unit
Forward Voltage ( $V_F$ )		GB	BZ	5.8	-	6.0	V
			B1	6.0	-	6.2	
			B2	6.2	-	6.4	
			B3	6.4	-	6.6	
Reverse Voltage (@ 5 mA)				0.7	-	1.2	V
Color Rendering Index ( $R_a$ )		5		80	-	-	
Special CRI (R9)				0	-	-	-
Thermal Resistance (junction to solder point)				-	12	-	°C/W
Beam Angle				-	120	-	°

#### Note:

Samsung maintains measurement tolerance of: forward voltage =  $\pm 0.1 \text{ V}$ , luminous flux =  $\pm 5 \%$ , CRI =  $\pm 3$ , R9 =  $\pm 6.5$

## 2. Product Code Information

1	2	3	4	5	6	7	8	9	10	11	12	13	14	15	16	17	18
S	P	M	W	H	T	3	2	6	F	D	5	G	B	V	0	S	A

Digit	PKG Information	Code	Specification
1 2 3	Samsung Package Middle Power	<b>SPM</b>	
4 5	Color	<b>WH</b>	White
6	Product Version	<b>T</b>	1: No Zener version 3: Zener version
7 8 9	Form Factor	<b>326</b>	3.0 x 3.0 x 0.65 mm
10	Sorting Current	<b>F</b>	150 mA
11	Chromaticity Coordinates	<b>D</b>	MacAdam
12	CRI	<b>5</b>	Min. 80
13 14	Forward Voltage (V)	<b>G B</b>	5.8~6.6 Bin Code: <b>BZ</b> 5.8~6.0 <b>B1</b> 6.0~6.2 <b>B2</b> 6.2~6.4 <b>B3</b> 6.4~6.6
15 16	CCT (K)	<b>W</b> ☆ <b>V</b> ☆ <b>U</b> ☆ <b>T</b> ☆ <b>R</b> ☆ <b>Q</b> ☆ <b>P</b> ☆	2700 WN, WP, WQ, WR, WS, WT, WU 3000 VN, VP, VQ, VR, VS, VT, VU 3500 UN, UP, UQ, UR, US, UT, UU 4000 Bin Code: TN, TP, TQ, TR, TS, TT, TU 5000 RN, RP, RQ, RR, RS, RT, RU 5700 QN, QP, QQ, QR, QS, QT, QU 6500 PN, PP, PQ, PR, PS, PT, PU ☆ : "0" (Whole Bin) "3" (MacAdam 3- step) "Y" (Kitting)
17 18	Luminous Flux (lm)	<b>SA</b>	Bin Code: SA

**a) Luminous Flux Bins ( $I_F = 150 \text{ mA}$ ,  $T_s = 25 \text{ °C}$ )**

Nominal CCT (K)	CRI Min.	Product Code	Flux Bin	Flux Range ( $\Phi_v$ , lm)
2700	80	SPMWH★326FD5GBW☆SA	SA	122 - 132
3000	80	SPMWH★326FD5GBV☆SA	SA	123 - 133
3500	80	SPMWH★326FD5GBU☆SA	SA	126 - 136
4000	80	SPMWH★326FD5GBT☆SA	SA	128 - 138
5000	80	SPMWH★326FD5GBR☆SA	SA	130 - 140
5700	80	SPMWH★326FD5GBQ☆SA	SA	128 - 138
6500	80	SPMWH★326FD5GBP☆SA	SA	127 - 137

**Note:**

★ : "1" (No Zener) or "3" (Zener)

☆ : "0" (Whole Bin) or "Y" (Kitting)

## b) Kitting Rule

### 1) Y Kitting bin Concept

1. Under agreement between customer and SAMSUNG ELECTRONICS, SAMSUNG can supply kitting bin (VF, Color, Im).
2. A forward voltage (VF) of kitting bin is combined by a pair of same VF rank such as (A2+A2) or (A3+A3).
3. A Chromaticity Coordinates of kitting bin is mixed by kitting procedure.(below kitting simulation)

#### [Kitting example]

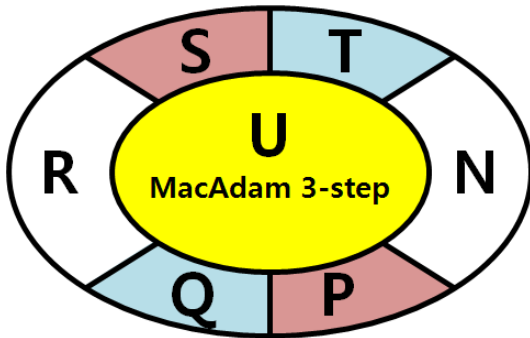

#### [Binning Information]

	Bin #1	Bin #2
VF	BZ	BZ
	B1	B1
	B2	B2
	B3	B3
CIE	U	U
	N	R
	P	S
	Q	T

**c) Color Bins (I<sub>F</sub> = 150 mA, T<sub>s</sub> = 25 °C)**

Nominal CCT	CRI	Product Code	Color Rank	Chromaticity Bins
2700	80	SPMWH★326FD5GBW0SA	W0 (Whole Bin)	WN, WP, WQ, WR, WS, WT, WU
		SPMWH★326FD5GBW3SA	W3 (MacAdam 3-step)	WU
		SPMWH★326FD5GBWYSA	WY (Kitting)	WN, WP, WQ, WR, WS, WT, WU
3000	80	SPMWH★326FD5GBV0SA	V0 (Whole Bin)	VN, VP, VQ, VR, VS, VT, VU
		SPMWH★326FD5GBV3SA	V3 (MacAdam 3-step)	VU
		SPMWH★326FD5GBVYSA	VY (Kitting)	VN, VP, VQ, VR, VS, VT, VU
3500	80	SPMWH★326FD5GBU0SA	U0 (Whole Bin)	UN, UP, UQ, UR, US, UT, UU
		SPMWH★326FD5GBU3SA	U3 (MacAdam 3-step)	UU
		SPMWH★326FD5GBUYSA	UY (Kitting)	UN, UP, UQ, UR, US, UT, UU
4000	80	SPMWH★326FD5GBT0SA	T0 (Whole Bin)	TN, TP, TQ, TR, TS, TT, TU
		SPMWH★326FD5GBT3SA	T3 (MacAdam 3-step)	TU
		SPMWH★326FD5GBTYSA	TY (Kitting)	TN, TP, TQ, TR, TS, TT, TU
5000	80	SPMWH★326FD5GBR0SA	R0 (Whole Bin)	RN, RP, RQ, RR, RS, RT, RU
		SPMWH★326FD5GBR3SA	R3 (MacAdam 3-step)	RU
		SPMWH★326FD5GBRYSA	RY (Kitting)	RN, RP, RQ, RR, RS, RT, RU
5700	80	SPMWH★326FD5GBQ0SA	Q0 (Whole Bin)	QN, QP, QQ, QR, QS, QT, QU
		SPMWH★326FD5GBQ3SA	Q3 (MacAdam 3-step)	QU
		SPMWH★326FD5GBQYSA	QY (Kitting)	QN, QP, QQ, QR, QS, QT, QU
6500	80	SPMWH★326FD5GBP0SA	P0 (Whole Bin)	PN, PP, PQ, PR, PS, PT, PU
		SPMWH★326FD5GBP3SA	P3 (MacAdam 3-step)	PU
		SPMWH★326FD5GBPYSA	PY (Kitting)	PN, PP, PQ, PR, PS, PT, PU

“★” can be “1” (No Zener), “3” (Zener)

**d) Voltage Bins (I<sub>F</sub> = 150 mA, T<sub>s</sub> = 25 °C)**

Nominal CCT (K)	CRI Min.	Product Code	Voltage Rank	Voltage Bin	Voltage Range (V)
-	-	-	GB	BZ	5.8 ~ 6.0
-	-	-		B1	6.0 ~ 6.2
-	-	-		B2	6.2 ~ 6.4
-	-	-		B3	6.4 ~ 6.6

e) Chromaticity Region & Coordinates ( $I_F = 150$  mA,  $T_s = 25$  °C)

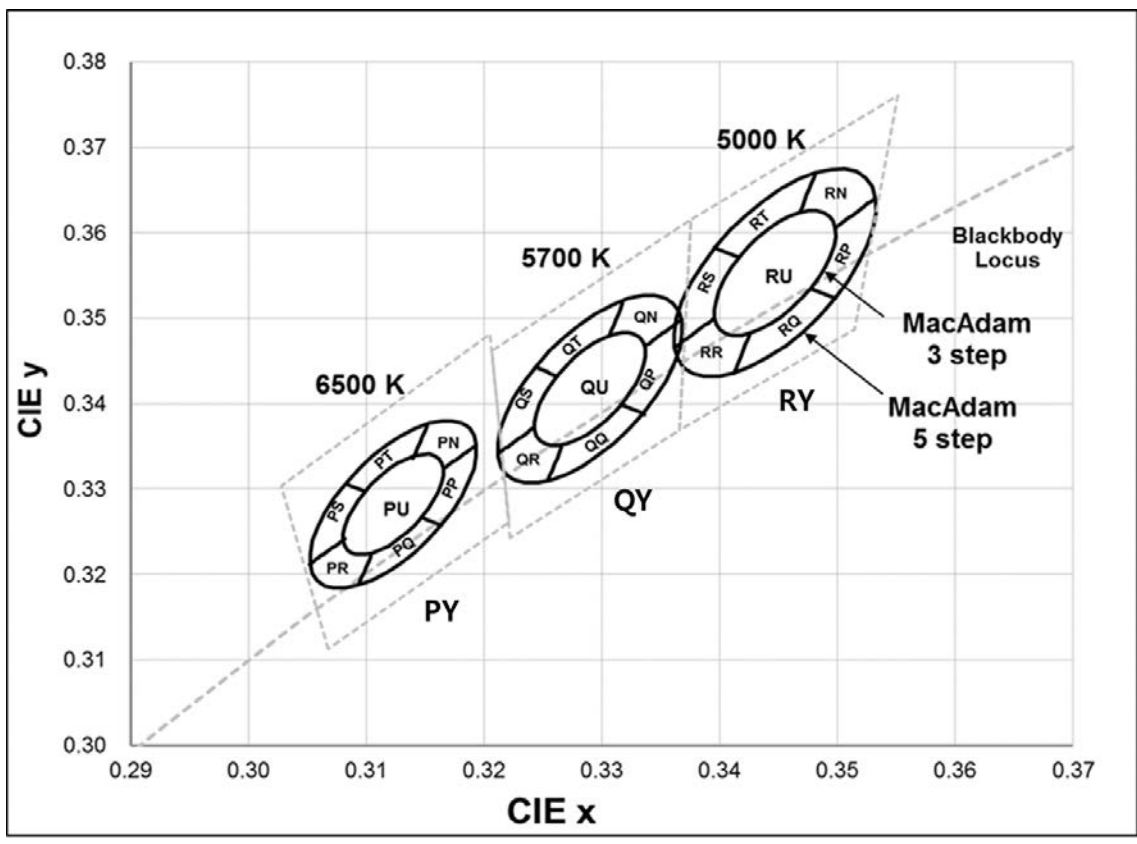
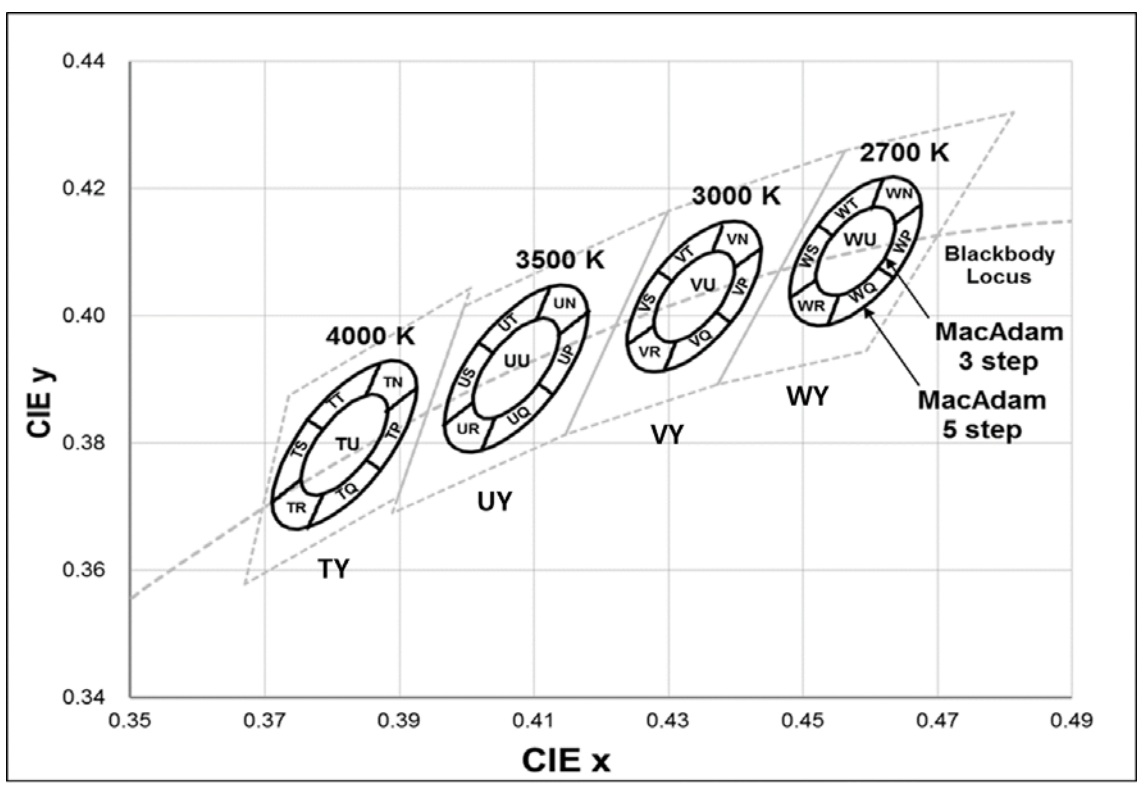



f) Chromaticity Region & Coordinates ( $I_F = 150 \text{ mA}$ ,  $T_s = 25 \text{ }^\circ\text{C}$ )

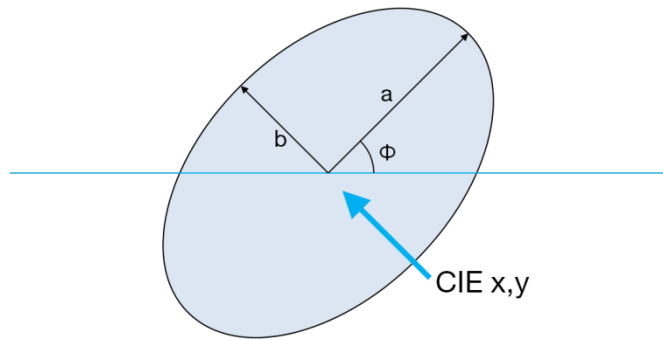

MacAdam	CCT (K)	Center point		Major-axis	Minor-axis	Rotation
		CIE <sub>x</sub>	CIE <sub>y</sub>	a	b	φ
3 step	2700	0.4578	0.4101	0.0081	0.0042	53.70
	3000	0.4338	0.4030	0.0083	0.0041	53.22
	3500	0.4073	0.3917	0.0093	0.0041	54.00
	4000	0.3818	0.3797	0.0094	0.0040	53.72
	5000	0.3447	0.3553	0.0082	0.0035	59.62
	5700	0.3287	0.3417	0.0075	0.0032	59.10
	6500	0.3123	0.3282	0.0067	0.0029	58.57
5 step	2700	0.4578	0.4101	0.0135	0.0070	53.70
	3000	0.4338	0.4030	0.0138	0.0068	53.22
	3500	0.4073	0.3917	0.0155	0.0068	54.00
	4000	0.3818	0.3797	0.0157	0.0067	53.72
	5000	0.3447	0.3553	0.0137	0.0058	59.62
	5700	0.3287	0.3417	0.0125	0.0053	59.10
	6500	0.3123	0.3282	0.0112	0.0048	58.57

**Note:**

Samsung maintains measurement tolerance of:  $C_x, C_y = \pm 0.005$

e) Chromaticity Region & Coordinates

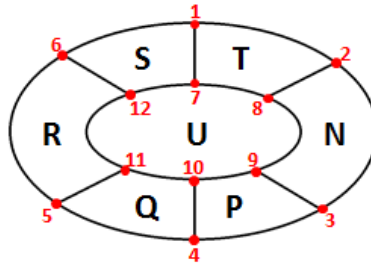

CCT	Region	CIE x	CIE y	CCT	Region	CIE x	CIE y	CCT	Region	CIE x	CIE y
2700K	1	0.4521	0.4142	3000K	1	0.4283	0.4071	3500K	1	0.4018	0.3957
	2	0.4619	0.4216		2	0.4382	0.4146		2	0.4125	0.4046
	3	0.4675	0.4175		3	0.4437	0.4105		3	0.418	0.4005
	4	0.4634	0.4059		4	0.4393	0.3989		4	0.4128	0.3877
	5	0.4537	0.3986		5	0.4293	0.3913		5	0.4022	0.3788
	6	0.4481	0.4028		6	0.4239	0.3954		6	0.3966	0.3828
	7	0.4544	0.4126		7	0.4305	0.4054		7	0.404	0.3941
	8	0.4603	0.417		8	0.4364	0.41		8	0.4104	0.3994
	9	0.4636	0.4145		9	0.4397	0.4075		9	0.4137	0.397
	10	0.4612	0.4076		10	0.4371	0.4005		10	0.4106	0.3893
	11	0.4553	0.4032		11	0.4311	0.396		11	0.4042	0.384
	12	0.452	0.4057		12	0.4279	0.3984		12	0.4009	0.3864
4000K	1	0.3764	0.3837	5000K	1	0.3397	0.3583	5700K	1	0.3242	0.3445
	2	0.3871	0.3926		2	0.3482	0.367		2	0.332	0.3524
	3	0.3925	0.3887		3	0.3532	0.364		3	0.3365	0.3496
	4	0.3872	0.3758		4	0.3497	0.3524		4	0.3333	0.339
	5	0.3765	0.3668		5	0.3412	0.3436		5	0.3254	0.331
	6	0.3711	0.3707		6	0.3362	0.3465		6	0.3209	0.3338
	7	0.3786	0.3821		7	0.3417	0.3571		7	0.326	0.3434
	8	0.385	0.3874		8	0.3468	0.3623		8	0.3307	0.3481
	9	0.3882	0.3851		9	0.3498	0.3605		9	0.3334	0.3464
	10	0.385	0.3773		10	0.3477	0.3535		10	0.3314	0.3401
	11	0.3786	0.372		11	0.3426	0.3483		11	0.3267	0.3353
	12	0.3754	0.3743		12	0.3396	0.35		12	0.324	0.3369

## e) Chromaticity Region &amp; Coordinates

CCT	Region	CIE x	CIE y
6500K	1	0.3082	0.3307
	2	0.3153	0.3377
	3	0.3194	0.3352
	4	0.3164	0.3257
	5	0.3093	0.3187
	6	0.3052	0.3212
	7	0.3098	0.3297
	8	0.3141	0.3339
	9	0.3166	0.3324
	10	0.3148	0.3267
	11	0.3105	0.3225
	12	0.308	0.324

### 3. Typical Characteristics Graphs

#### a) Spectrum Distribution ( $I_f = 150 \text{ mA}$ , $T_s = 25 \text{ }^\circ\text{C}$ )

CCT: 2700 K (80 CRI)

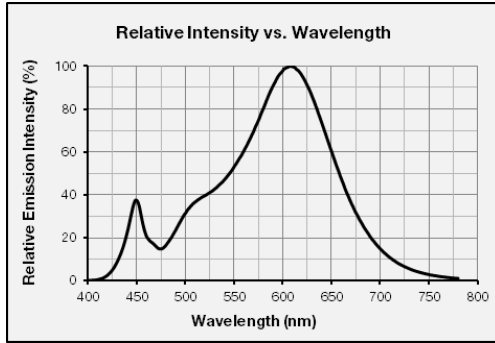

CCT: 3000 K (80 CRI)

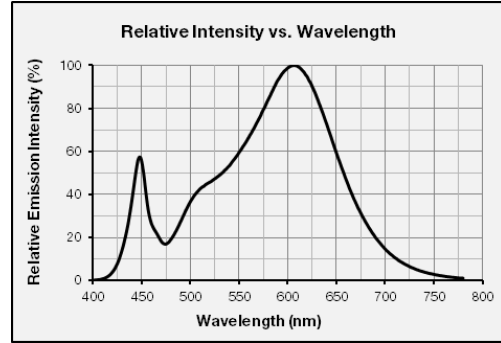

CCT: 3500 K (80 CRI)

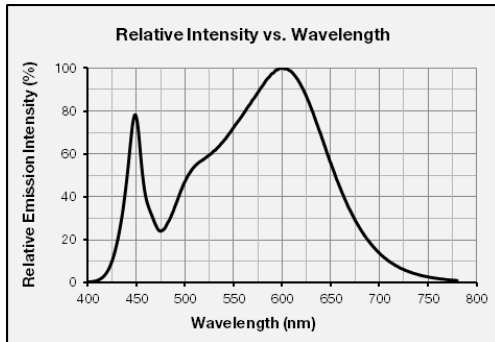

CCT: 4000 K (80 CRI)

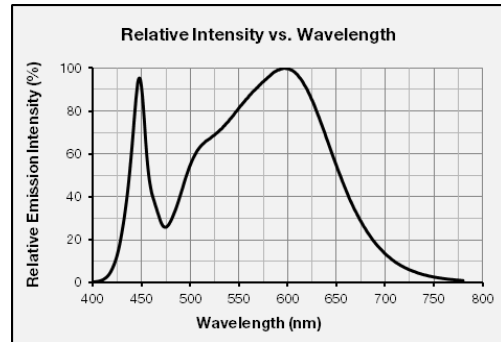

CCT: 5000 K (80 CRI)

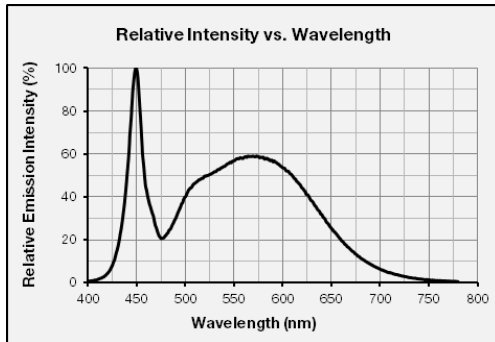

CCT: 5700 K (80 CRI)

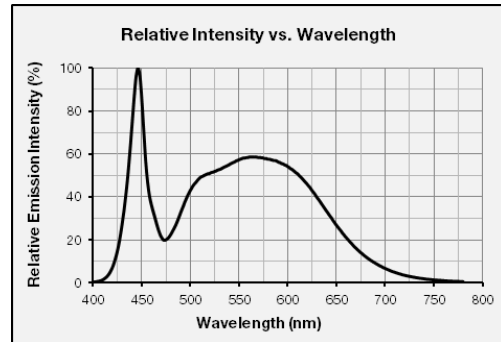

CCT: 6500 K (80 CRI)

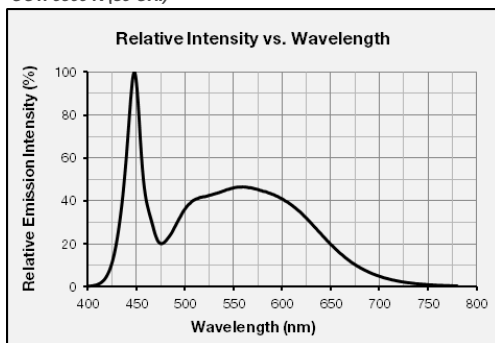

**b) Forward Current Characteristics ( $T_s = 25\text{ }^\circ\text{C}$ )**

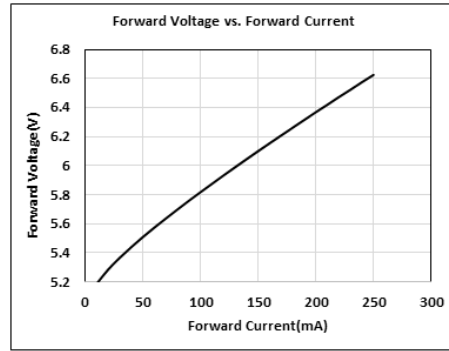
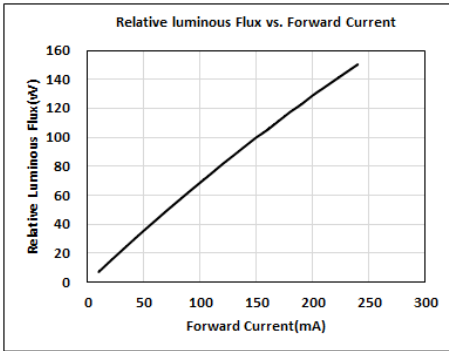

**c) Temperature Characteristics ( $I_f = 150\text{ mA}$ )**

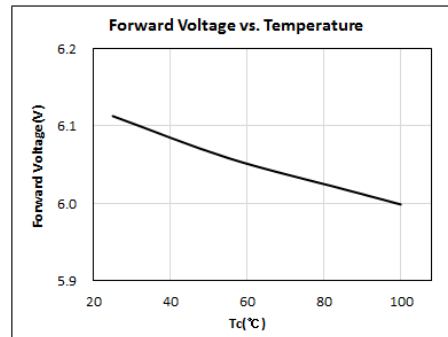
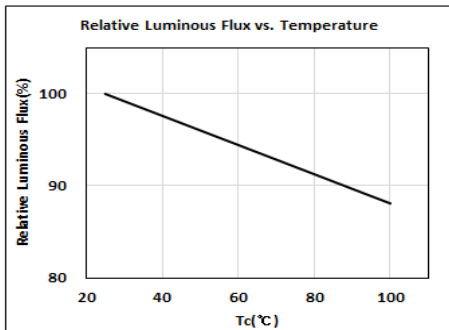

**d) Color Shift Characteristics ( $T_s = 25\text{ }^\circ\text{C}$ ,  $I_f = 150\text{ mA}$ )**

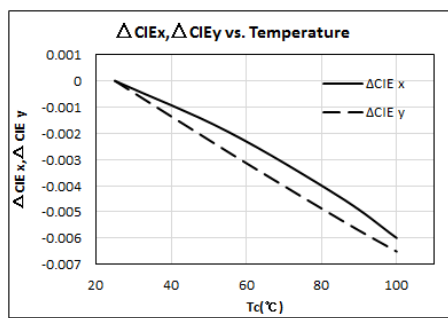
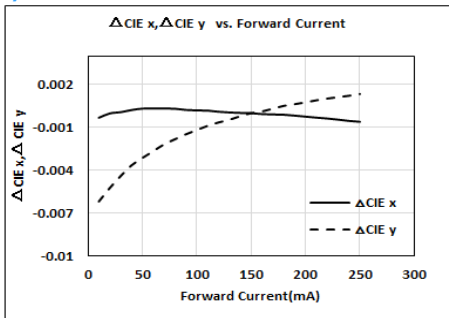

**e) Derating Curve**

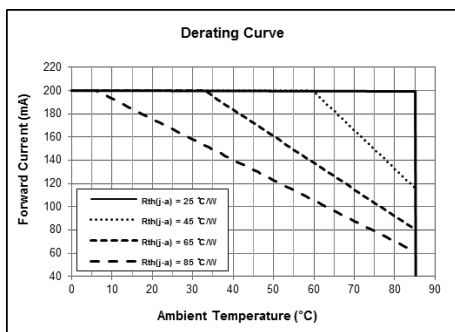

**f) Beam Angle Characteristics ( $I_f = 150\text{ mA}$ ,  $T_s = 25\text{ }^\circ\text{C}$ )**

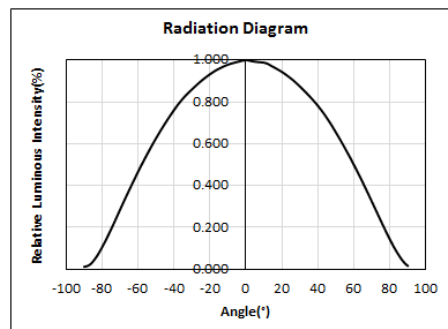

#### 4. Outline Drawing & Dimension

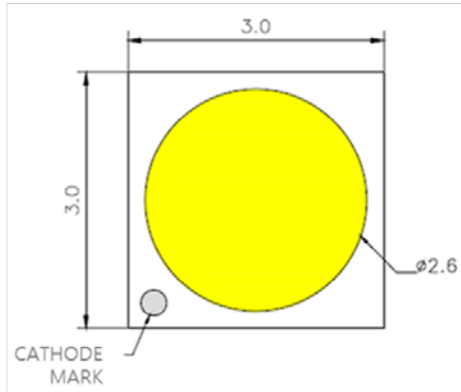

[TOP VIEW]

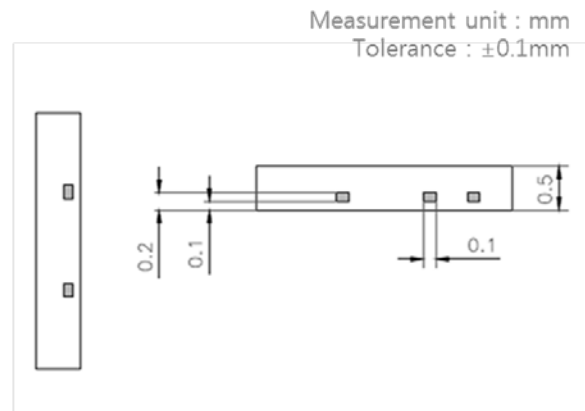

[SIDE VIEW]

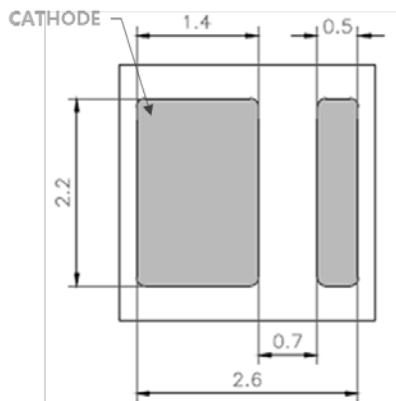

[BOTTOM VIEW]

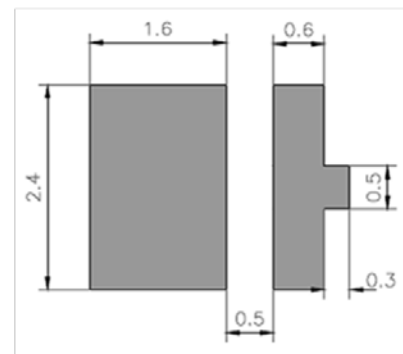

[RECOMMENDED PCB SOLDER PAD]

#### Notes:

- 1) This LED has built-in ESD protection device(s) connected in parallel to LED chip(s).
- 2)  $T_s$  point and measurement method:
  - ① Measure one point at the cathode pad, if necessary remove PSR of PCB to reach  $T_s$  point.
  - ② All pads must be soldered to the PCB to dissipate heat properly, otherwise the LED can be damaged.

#### Precautions:

- 1) Pressure on the LEDs will influence to the reliability of the LEDs. Precautions should be taken to avoid strong pressure on the LEDs. Do not put stress on the LEDs during heating.
- 2) Re-soldering should not be done after the LEDs have been soldered. If re-soldering is unavoidable, LED's characteristics should be carefully checked before and after such repair.

- 3) Do not stack assembled PCBs together. Since materials of LEDs is soft, abrasion between two PCB assembled with LED might cause catastrophic failure of the LEDs.

## 5. Reliability Test Items & Conditions

### a) Test Items

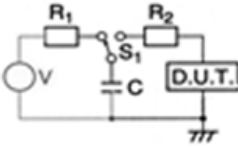
Test Item	Test Condition	Test Hour / Cycle	Sample No.	
Room Temperature Life Test	25 °C, DC 200 mA	1000 h	22	
High Temperature Life Test	85 °C, DC 200 mA	1000 h	22	
High Temperature Humidity Life Test	60 °C, 90 % RH, DC 200 mA	1000 h	22	
Low Temperature Life Test	-40 °C, DC 200 mA	1000 h	22	
Powered Temperature Cycle Test	-45 °C / 20 min ↔ 85 °C / 20 min, sweep 100 min cycle on/off: each 5 min, DC 200 mA	100 cycles	22	
Thermal Cycle	-40 °C / 15 min ↔ 100 °C / 15 min → Hot plate 180 °C	500 cycles	100	
High Temperature Storage	120 °C	1000 h	11	
Low Temperature Storage	-40 °C	1000 h	11	
ESD (HBM)		$R_1$ : 10 M $\Omega$ $R_2$ : 1.5 k $\Omega$ C: 100 pF V: $\pm 5$ kV	5 times	30
		$R_1$ : 10 M $\Omega$ $R_2$ : 0 C: 200 pF V: $\pm 0.5$ kV	5 times	30
ESD (MM)				
Vibration Test	20~2000~20 Hz, 200 m/s <sup>2</sup> , sweep 4 min X, Y, Z 3 direction, each 1 cycle	4 cycles	11	
Mechanical Shock Test	1500 g, 0.5 ms 3 shocks each X-Y-Z axis	5 cycles	11	

### b) Criteria for Judging the Damage

Item	Symbol	Test Condition ( $T_s = 25$ °C)	Limit	
			Min	Max
Forward Voltage	$V_F$	$I_F = 150$ mA	Init. Value * 0.9	Init. Value * 1.1
Luminous Flux	$\Phi_v$	$I_F = 155$ mA	Init. Value * 0.7	Init. Value * 1.1

## 6. Soldering Conditions

### a) Reflow Conditions (Pb free)

Reflow frequency: 2 times max.

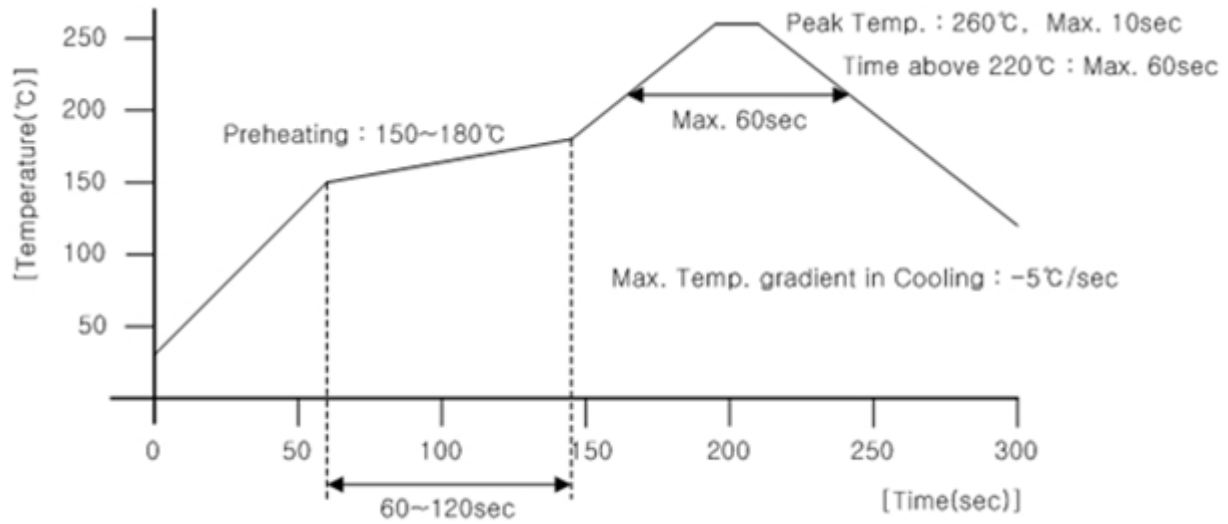

### b) Manual Soldering Conditions

Not more than 5 seconds @ max. 300 °C, under soldering iron.



## 7. Tape & Reel

### a) Taping Dimension

(unit: mm)

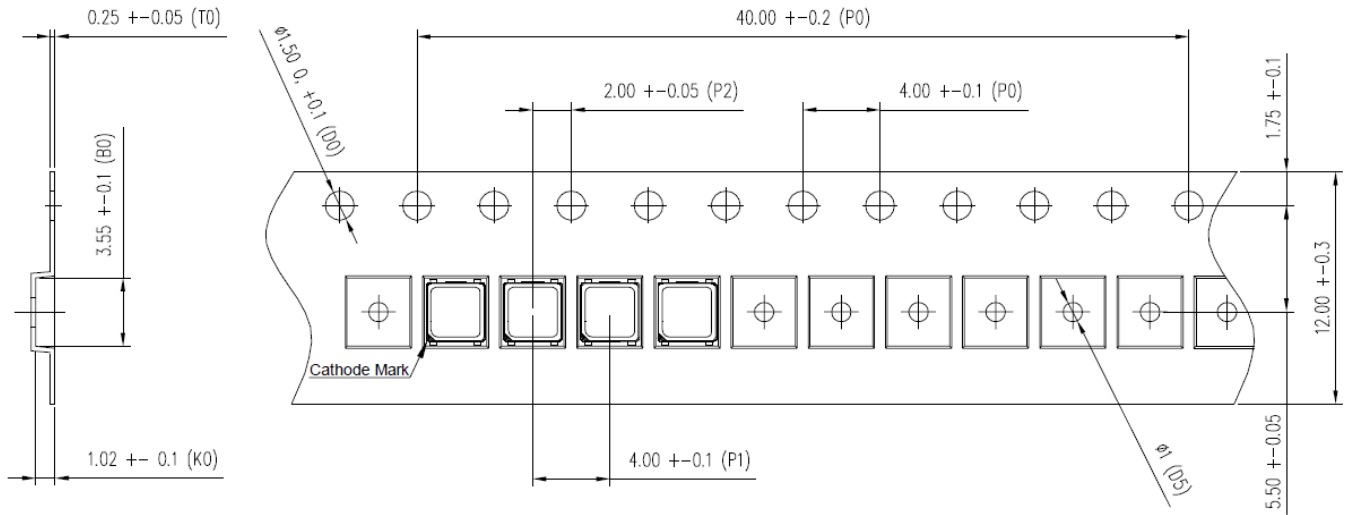

Taping Direction

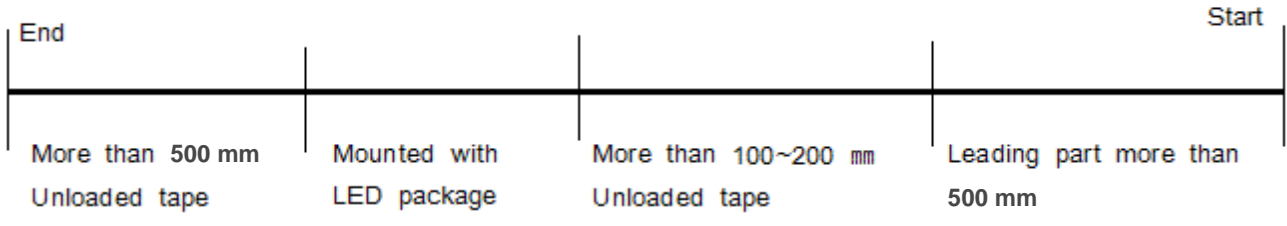
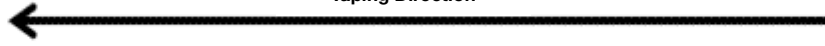

## b) Reel Dimension

(unit: mm)

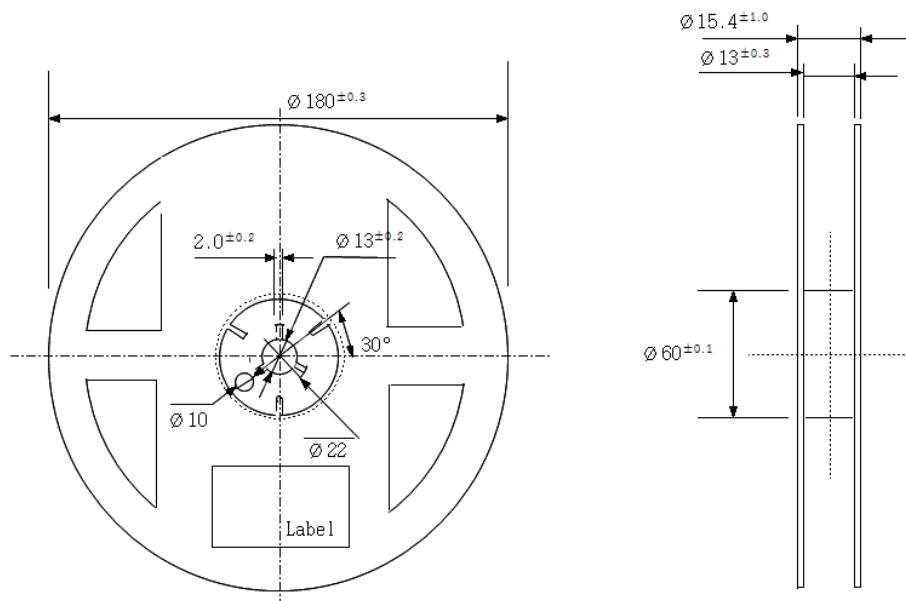
**Notes:**

- 1) Quantity: The quantity/reel is 5,000 pcs
- 2) Cumulative Tolerance: Cumulative tolerance / 10 pitches is  $\pm 0.2$  mm
- 3) Adhesion Strength of Cover Tape: Adhesion strength is 0.1-0.7 N when the cover tape is turned off from the carrier tape at  $10^\circ$  angle to the carrier tape
- 4) Packaging: P/N, Manufacturing data code no. and quantity are indicated on the aluminum packing bag

## 8. Label Structure

### a) Label Structure

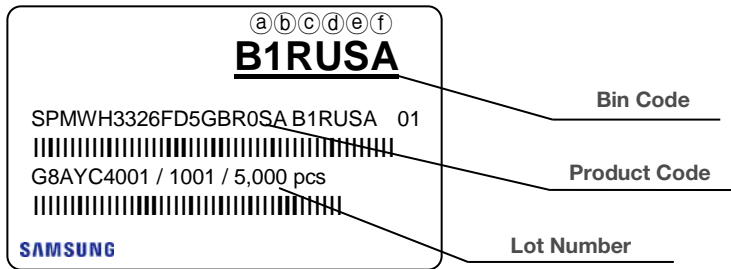

Note: Denoted bin code and product code above is only an example (see description on page 5)

Bin Code:

- ⒶⒷ: Forward Voltage bin (refer to page 8)
- ⒸⒹ: Chromaticity bin (refer to page 10-13)
- ⒺⒻ: Luminous Flux bin (refer to page 8)

### b) Lot Number

The lot number is composed of the following characters:

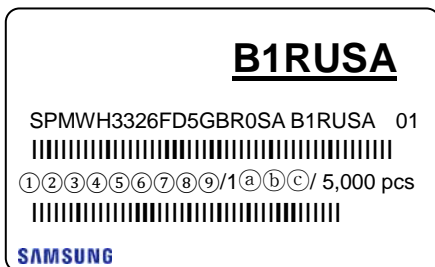

① ②③④⑤⑥⑦⑧⑨ / 1ⒶⒷⒸ / 5,000 pcs

- ① : Production site (S: Giheung, Korea, G: Tianjin, China)
- ② : 8 (LED)
- ③ : Product state (A: Normal, B: Bulk, C: First Production, R: Reproduction, S: Sample)
- ④ : Year (Z: 2015, A: 2016, B: 2017...)
- ⑤ : Month (1~9, A, B, C)
- ⑥⑦⑧⑨ : Day (1~9, A, B~V)
- ⒶⒷⒸ : Product serial number (001 ~ 999)



**b) Packing Process for kitting (The quantity of PKG on the Reel to be Max 5,000pcs)**

**Reel**

**Kitting 'A'**



**B1★YSA**

SPMWH3326FD5GB★YSA B1★YSA 01

|||||

G8AW94001 / 1001 / 5,000 pcs

|||||

**SAMSUNG**

**Kitting 'B'**



**B1★YSA**

SPMWH3326FD5GB★YSA B1★YSA 01

|||||

G8AW94001 / 1001 / 5,000 pcs

|||||

**SAMSUNG**

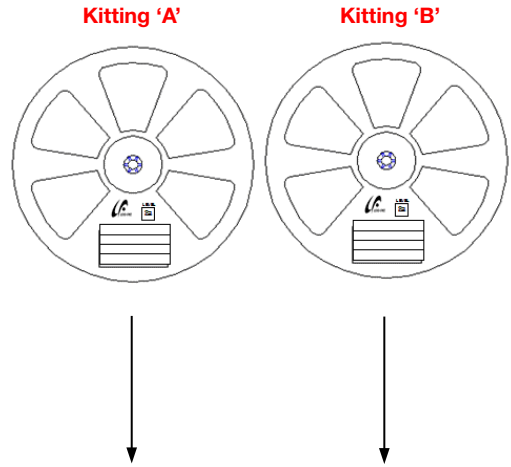

**Aluminum Vinyl Packing Bag**

**Kitting 'A'**



**B1★YSA**

SPMWH3326FD5GB★YSA B1★YSA 01

|||||

G8AW94001 / 1001 / 5,000 pcs

|||||

**SAMSUNG**

**Kitting 'B'**



**B1★YSA**

SPMWH3326FD5GB★YSA B1★YSA 01

|||||

G8AW94001 / 1001 / 5,000 pcs

|||||

**SAMSUNG**

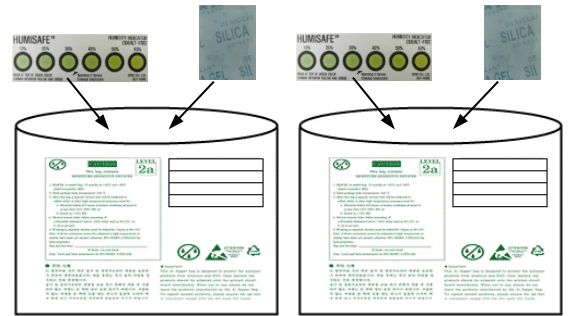

**Outer Box**

**Kitting 'A'**



**B1★YSA**

SPMWH3326FD5GB★YSA B1★YSA 01

|||||

G8AW94001 / 1001 / 50,000 pcs

|||||

**SAMSUNG** [BOX Label]

**Kitting 'B'**



**B1★YSA**

SPMWH3326FD5GB★YSA B1★YSA 01

|||||

G8AW94001 / 1001 / 50,000 pcs

|||||

**SAMSUNG** [BOX Label]

Note: "★" can be Nominal CCT code.

Material: Paper (SW3B(B))

Type	Size (mm)			Note
	L	W	H	
7 inch L	245 ± 5	220 ± 5	182 ± 5	Up to 10 reels

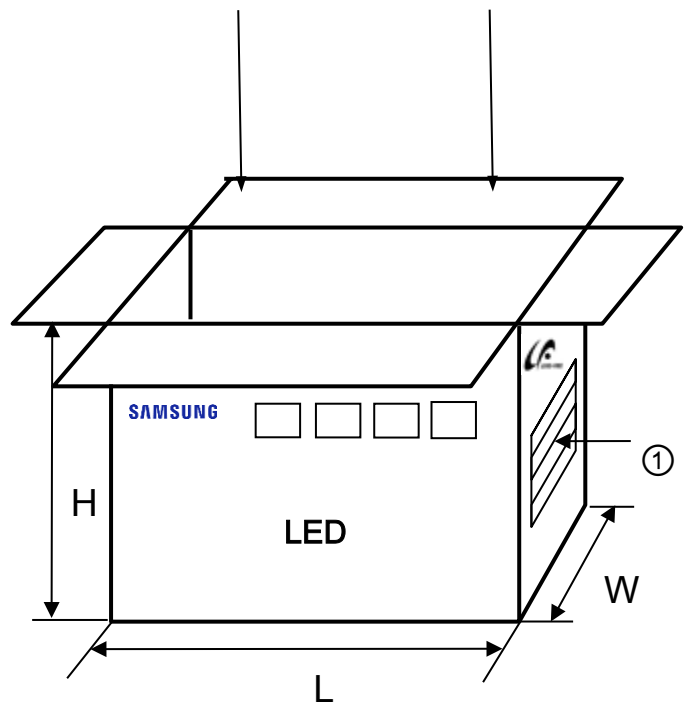



## 10. Precautions in Handling & Use

- 1) For over-current-proof function, customers are recommended to apply resistors to prevent sudden change of the current caused by slight shift of the voltage.
- 2) This device should not be used in any type of fluid such as water, oil, organic solvent, etc. When washing is required, IPA is recommended to use.
- 3) When the LEDs illuminate, operating current should be decided after considering the ambient maximum temperature.
- 4) LEDs must be stored in a clean environment. If the LEDs are to be stored for three months or more after being shipped from Samsung, they should be packed by a sealed container with nitrogen gas injected (shelf life of sealed bags: 12 months, temperature ~40 °C, ~90 % RH).
- 5) After storage bag is opened, device subjected to soldering, solder reflow, or other high temperature processes must be:
  - a. Mounted within 672 hours (28 days) at an assembly line with a condition of no more than 30 °C / 60 % RH, or
  - b. Stored at <10 % RH
- 6) Repack unused products with anti-moisture packing, fold to close any opening and then store in a dry place.
- 7) Devices require baking before mounting, if humidity card reading is >60 % at 23 ± 5 °C.
- 8) Devices must be baked for 10~24 hours at 60 ± 5 °C, if baking is required.
- 9) The LEDs are sensitive to the static electricity and surge. It is recommended to use a wrist band or anti-electrostatic glove when handling the LEDs. If voltage exceeding the absolute maximum rating is applied to LEDs, it may cause damage or even destruction to LED devices. Damaged LEDs may show some unusual characteristics such as increase in leak current, lowered turn-on voltage, or abnormal lighting of LEDs at low current.
- 10) VOCs (Volatile Organic Compounds) can be generated from adhesives, flux, hardener or organic additives used in luminaires (fixtures). Transparent LED silicone encapsulant is permeable to those chemicals and they may lead a discoloration of encapsulant when they exposed to heat or light. This phenomenon can cause a significant loss of light emitted (output) from the luminaires (fixtures). In order to prevent these problems, we recommend users to know the physical properties of the materials used in luminaires, and they must be selected carefully.
- 11) Risk of sulfurization (or tarnishing)

The LED from Samsung Electronics Co., Ltd. uses a silver-plated lead frame and its surface color may change to black (or dark colored) when it is exposed to sulfur (S), chlorine (Cl) or other halogen compound. Sulfurization of lead frame may cause intensity degradation, change of chromaticity coordinates and, in extreme cases, open circuit. It requires caution. Due to possible sulfurization of lead frame, LED should not be used and stored together with oxidizing substances made of materials such as: rubber, plain paper, lead solder cream, etc.

# Legal and additional information.

## [About Samsung Electronics Co., Ltd.](#)

Samsung inspires the world and shapes the future with transformative ideas and technologies.

The company is redefining the worlds of TVs, smartphones, wearable devices, tablets, digital appliances, network systems, and memory, system LSI, foundry and LED solutions. For the latest news, please visit the Samsung Newsroom at [news.samsung.com](http://news.samsung.com).

Copyright © 2018 Samsung Electronics Co., Ltd. All rights reserved.

Samsung is a registered trademark of Samsung Electronics Co., Ltd.

Specifications and designs are subject to change without notice. Non-metric weights and measurements are approximate. All data were deemed correct at time of creation. Samsung is not liable for errors or omissions. All brand, product, service names and logos are trademarks and/or registered trademarks of their respective owners and are hereby recognized and acknowledged.

Samsung Electronics Co., Ltd.

95, Samsung 2-ro

Giheung-gu

Yongin-si, Gyeonggi-do, 446-711

KOREA

[www.samsungled.com](http://www.samsungled.com)

**SAMSUNG**