

High Power LED Series

LH502C ECO General

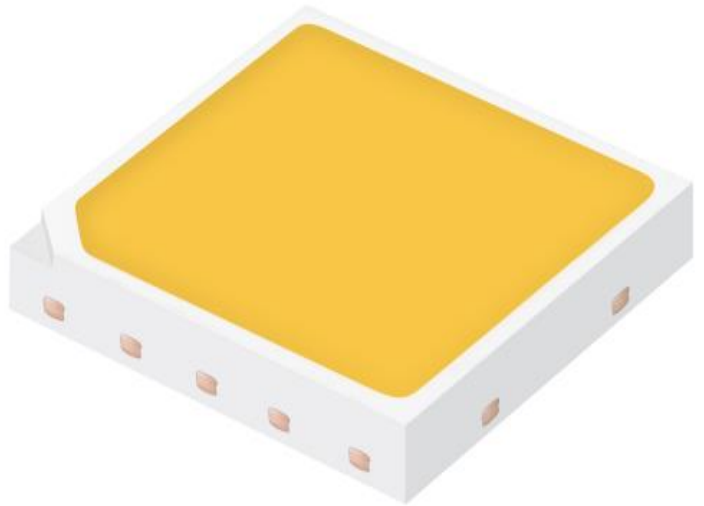

High efficacy and lumen makes

The LH502C ECO suitable for Streetlight and High-bay applications

Features & Benefits

- Operates at a maximum current of up to 880mA
- Uniform light distribution under any beam angle
- Color binning @ 85°C



Table of Contents

1.	Characteristics	-----	3
2.	Product Code Information	-----	5
3.	Typical Characteristics Graphs	-----	9
4.	Outline Drawing & Dimension	-----	12
5.	Reliability Test Items & Conditions	-----	13
6.	Soldering Conditions	-----	14
7.	Tape & Reel	-----	15
8.	Label Structure	-----	17
9.	Packing Structure	-----	18
10.	Precautions in Handling & Use	-----	20

1. Characteristics

a) Absolute Maximum Rating

Item	Symbol	Rating	Unit	Condition
Operating Temperature	T_{opr}	-40 ~ +85	°C	
Storage Temperature	T_{stg}	-40 ~ +100	°C	-
LED Junction Temperature	T_j	125	°C	-
Forward Current	I_F	880	mA	-
Peak Pulse Forward Current	I_{FP}	1000	mA	Duty cycle ≤ 1/10, pulse width 10ms
Soldering Temperature		260 <10	°C	-
Electrostatic Discharge Withstand Voltage(HBM)	ESD(HBM)	±2	kV	-

b) Electro-optical Characteristics ($I_F = 640 \text{ mA}$, $T_j = 25^\circ\text{C}$)

Item	Unit	Rank	Min.	Typ.	Max.
Forward Voltage (V_F)	V	YE	5.9	6.1	6.3
Color Rendering Index (R_a) / R9	-	3	70 / -50	-	-
		5	80 / 0	-	-
Thermal Resistance (junction to chip point)	°C/W		-	3	-
Beam Angle	°			120	

Notes:

Samsung maintains measurement tolerance of: luminous flux = ±7 %, forward voltage = ±0.1 V, CRI = ±1, R9 = ±6.5

c) Luminous Flux Characteristics ($I_F = 640 \text{ mA}$)

CRI (Ra) Min.	Nominal CCT (K)	Flux Rank	Flux @ $T_J = 25 \text{ }^\circ\text{C}$ (lm)		
			Min.	Typ.	Max.
70	2200K	A4	510		
	2700K	A4	590		
	3000K	A4	620		
	3500K	A4	640		
	4000K	A4	660		
	5000K	A4	660		
	5700K	A4	640		
	6500K	A4	630		
80	2200K	A4	470		
	2700K	A4	550		
	3000K	A4	560		
	3500K	A4	600		
	4000K	A4	610		
	5000K	A4	610		
	5700K	A4	600		
	6500K	A4	600		

Notes:

- 1) Tested in pulsed operating condition at rated test current (10 ms pulse width) and rated temperature
- 2) Samsung maintains measurement tolerance of: Luminous flux = $\pm 7 \%$, CRI = ± 1 , R9 = ± 6.5

2. Product Code Information

1	2	3	4	5	6	7	8	9	10	11	12	13	14	15	16	17	18
S	P	H	W	H	1	L	5	N	6	0	3	Y	E	T	5	A	4

Digit	PKG Information	Code	Specification		
1 2 3	Samsung Package High Power	SPH	High Power PKG		
4 5	Color	WH	White		
6	Product Version	1	1		
7 8	Form Factor	L5	5050 size		
9	Lens Type	N	No lens		
10	Model	6	5050 Series		
11	Internal Code	0			
12	CRI	3	Min. 70		
		5	Min. 80		
13 14	Forward Voltage (V)	YE	Bin code	A0	5.9 – 6.1
				A1	6.1 – 6.3
15	CCT (K)	Y	2200K		
		W	2700K		
		V	3000K		
		U	3500K		
		T	4000K		
		R	5000K		
		Q	5700K		
		P	6500K (CRI70/80)		
16	MacAdam Step	3	MacAdam 3-Step		
		5	MacAdam 5-Step		
17 18	Luminous Flux (lm)	A4	502C ECO lm Rank		

a) Luminous flux Rank (I_f = 640 mA, T_j = 25°C)

CRI (R _a) Min.	Nominal CCT(K)	Product Code	VF Rank	Chrom Rank (Bins)	Flux		Flux Range (Φ _v , lm)				
					Rank	Bins					
70	2200	SPHWH1L5N603YEY3A4	YE	Y3, Y5	A4		51	510-550			
		SPHWH1L5N603YEV5A4					55	550-590			
	2700	SPHWH1L5N603YEW3A4		W3, W5		59	590-630				
		SPHWH1L5N603YEW5A4				63	630-670				
	3000	SPHWH1L5N603YEV3A4		V3, V5		62	620-660				
		SPHWH1L5N603YEV5A4				66	660-700				
	3500	SPHWH1L5N603YEU3A4		U3, U5		64	640-680				
		SPHWH1L5N603YEU5A4				68	680-720				
	4000	SPHWH1L5N603YET3A4		T3, T5		66	660-700				
		SPHWH1L5N603YET5A4				70	700-740				
	5000	SPHWH1L5N603YER3A4		R3, R5		66	660-700				
		SPHWH1L5N603YER5A4				70	700-740				
	5700	SPHWH1L5N603YEQ3A4		Q3, Q5		64	640-680				
		SPHWH1L5N603YEQ5A4				68	680-720				
	6500	SPHWH1L5N603YEP3A4		P3, P5		63	630-670				
		SPHWH1L5N603YEP5A4				67	670-710				
	80	2200		SPHWH1L5N605YEY3A4		YE	Y3, Y5	A4		47	470-510
				SPHWH1L5N605YEV5A4						51	510-550
2700		SPHWH1L5N605YEW3A4	W3, W5	55	550-590						
		SPHWH1L5N605YEW5A4		59	590-630						
3000		SPHWH1L5N605YEV3A4	V3, V5	56	560-600						
		SPHWH1L5N605YEV5A4		60	600-640						
3500		SPHWH1L5N605YEU3A4	U3, U5	60	600-640						
		SPHWH1L5N605YEU5A4		64	640-680						
4000		SPHWH1L5N605YET3A4	T3, T5	61	610-650						
		SPHWH1L5N605YET5A4		65	650-690						
5000		SPHWH1L5N605YER3A4	R3, R5	61	610-650						
		SPHWH1L5N605YER5A4		65	650-690						
5700		SPHWH1L5N605YEQ3A4	Q3, Q5	60	600-640						
		SPHWH1L5N605YEQ5A4		64	640-680						
6500		SPHWH1L5N605YEP3A4	P3, P5	60	600-640						
		SPHWH1L5N605YEP5A4		64	640-680						

b) Voltage Bins ($I_f = 640 \text{ mA}$, $T_j = 25^\circ\text{C}$)

Nominal CCT (K)	CRI (R _a) Min.	Product Code	Voltage Rank	Voltage Bin	Voltage Range (V)
-	-	-	YE	A0	5.9 - 6.1
				A1	6.1 - 6.3

c) Chromaticity Region & Coordinates ($I_F = 640 \text{ mA}$, $T_j = 85^\circ\text{C}$)

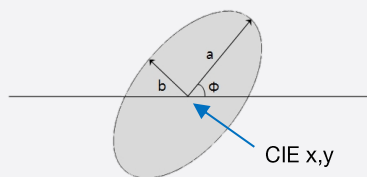
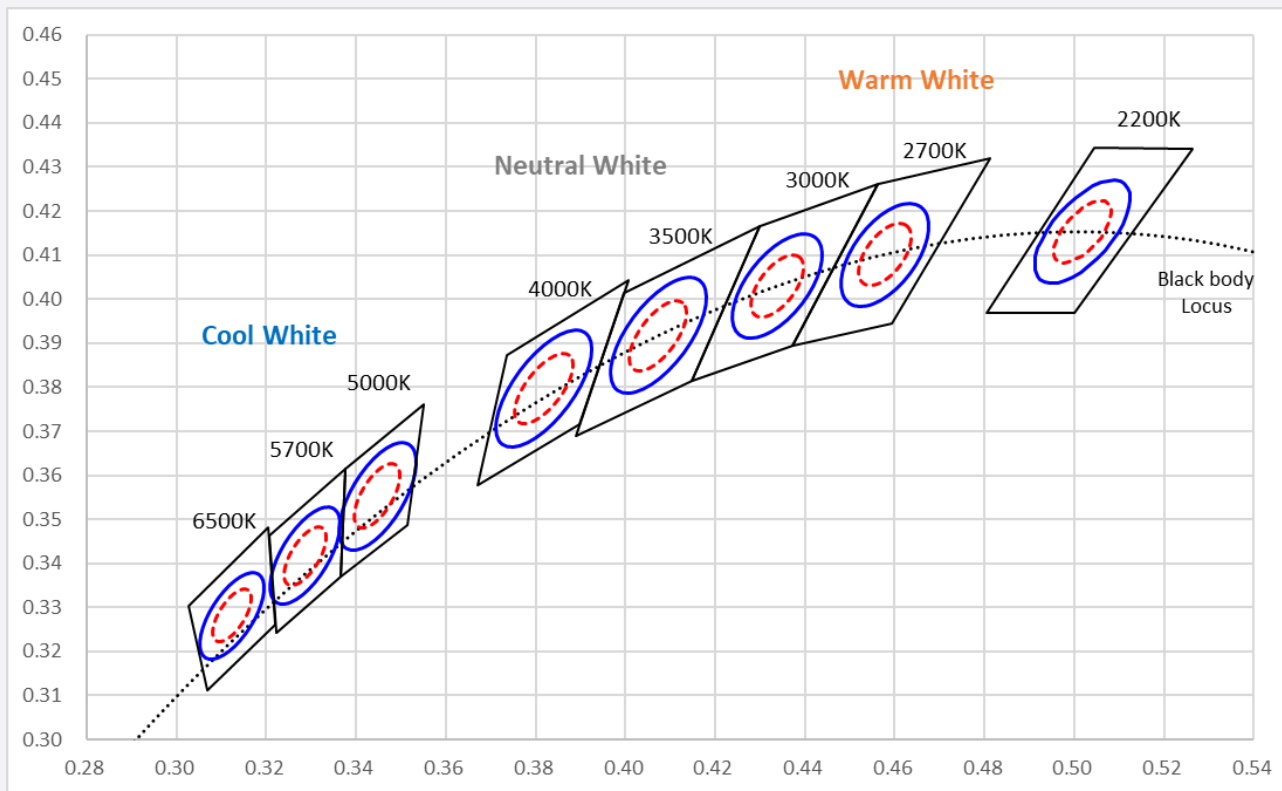

CRI	CCT	Rank	CIE x	CIE y	Φ	A	b
70 80 90	2200K	Y3	0.5019	0.4153	49.3	0.0086	0.0040
		Y5				0.0144	0.0066
	2700K	W3	0.4578	0.4101	53.7	0.0081	0.0042
		W5				0.0135	0.0070
	3000K	V3	0.4338	0.4030	53.2	0.0083	0.0041
		V5				0.0138	0.0068
	3500K	U3	0.4073	0.3917	54.0	0.0093	0.0041
		U5				0.0155	0.0069
	4000K	T3	0.3818	0.3797	53.7	0.0094	0.0040
		T5				0.0157	0.0067
	5000K	R3	0.3447	0.3553	59.6	0.0082	0.0035
		R5				0.0137	0.0058
	5700K	Q3	0.3287	0.3417	59.1	0.0075	0.0032
		Q5				0.0125	0.0053
	6500K	P3	0.3123	0.3282	58.6	0.0067	0.0029
		P5				0.0112	0.0048

Note : Samsung maintains measurement tolerance of: $C_x, C_y = \pm 0.005$

3. Typical Characteristic Graphs

a) Spectral Distribution ($I_F = 640 \text{ mA}$, $T_j = 25^\circ\text{C}$)

CRI70

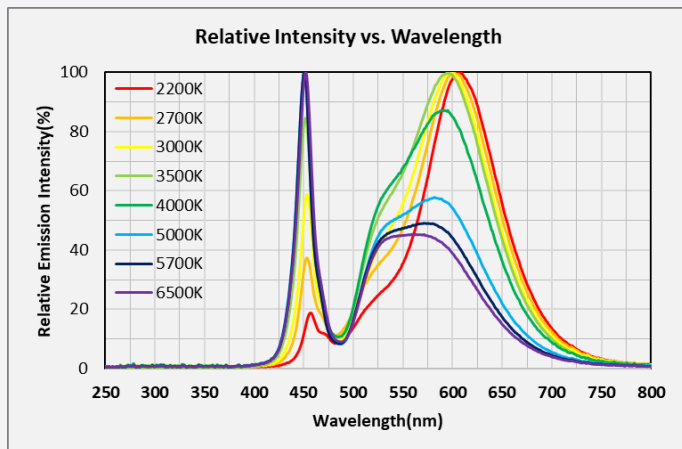

CRI80

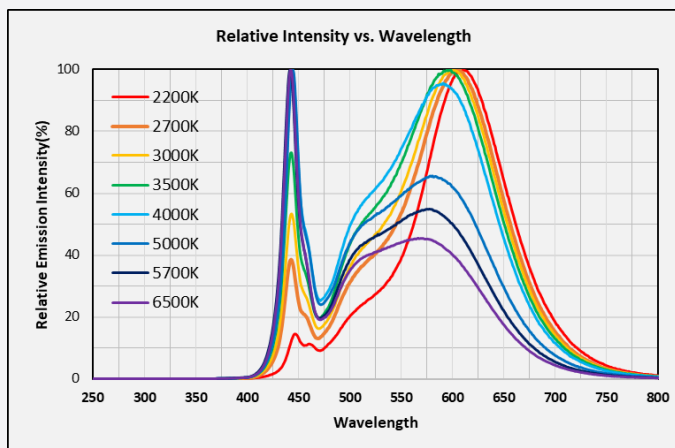

b) Forward Current Characteristics ($T_j = 25^\circ\text{C}$)

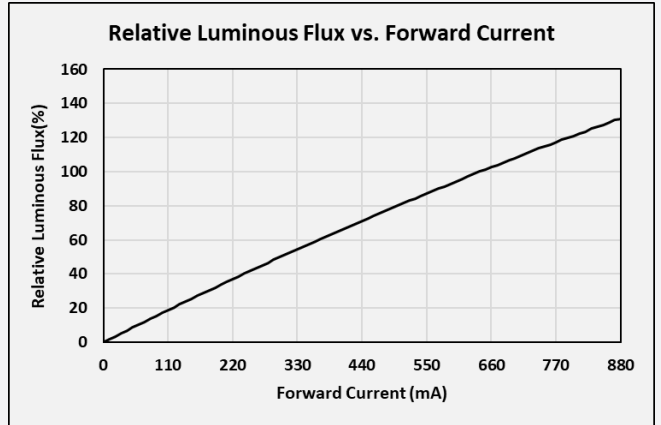
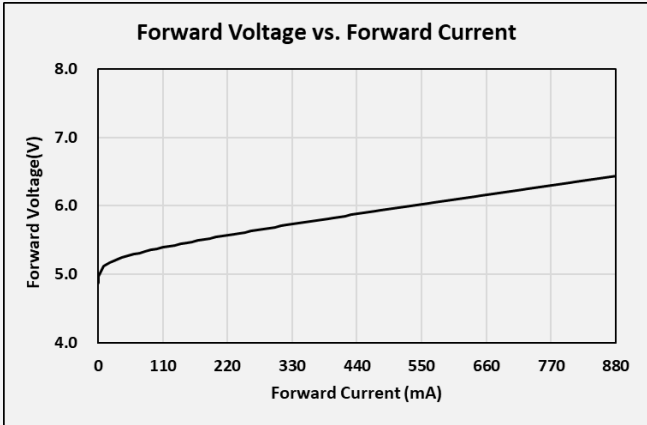

c) Temperature Characteristics ($I_f = 640\text{ mA}$)

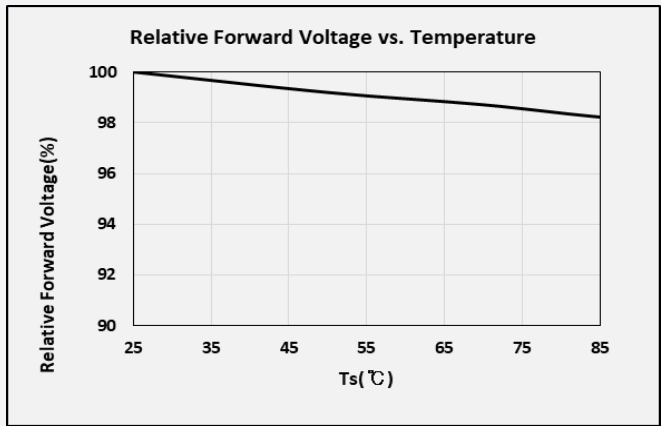
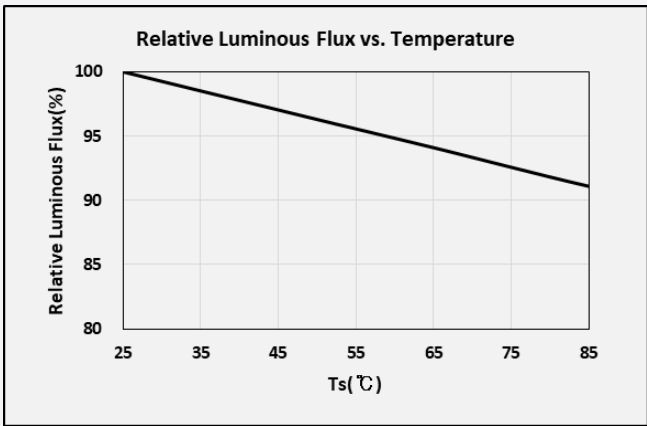

d) Color Shift Characteristics ($I_f = 640\text{ mA}$, $T_j = 25^\circ\text{C}$)

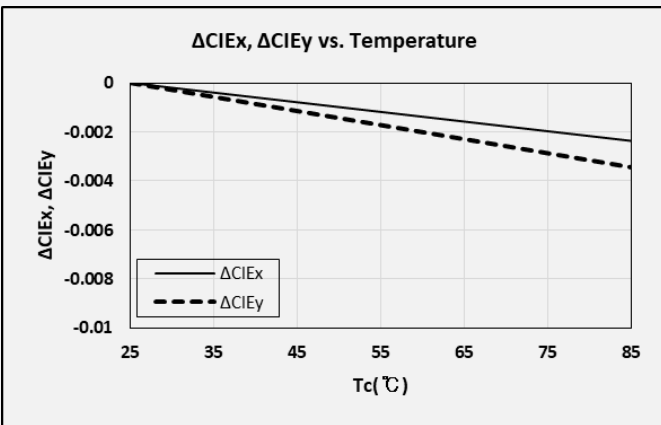
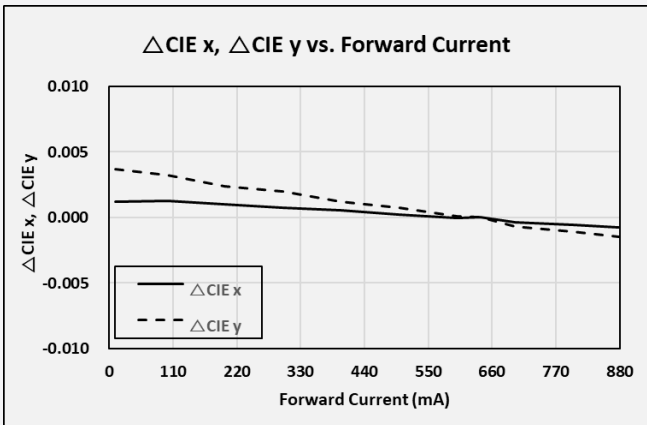

e) Beam Angle Characteristics ($I_f = 640 \text{ mA}$, $T_j = 25^\circ\text{C}$)

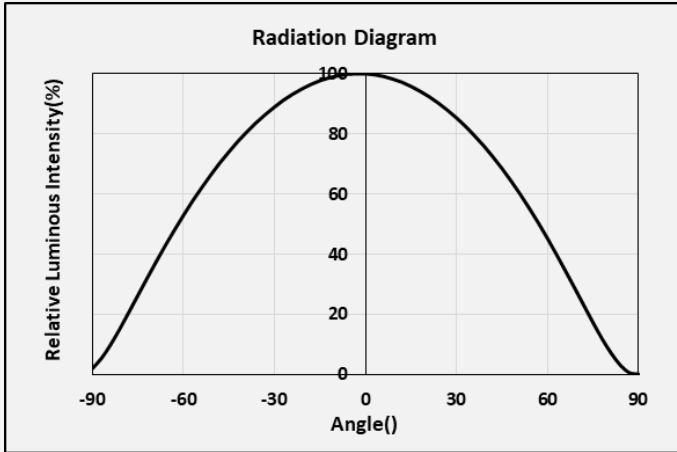

f) Derating Curve

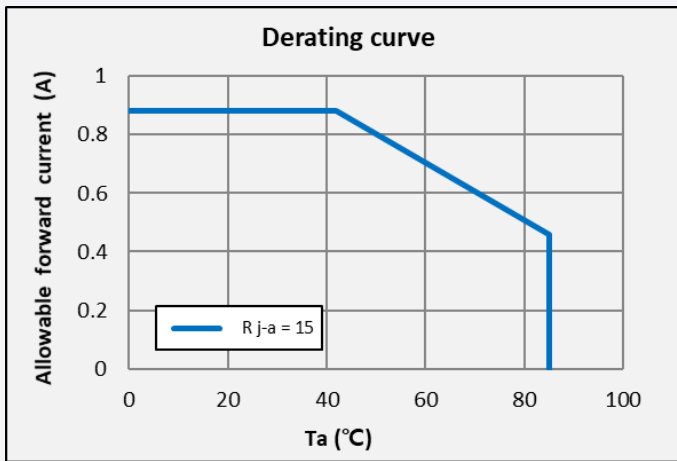

g) Luminous Flux Characteristics¹⁾ (CRI = 70, CCT = 4000K)

CRI (Ra) Min.	Nominal CCT (K)	I_f	Typ. @ $T_j = 25^\circ\text{C}$		
			V_f , Forward voltage	I_m , Flux	I_m/W_f , Luminous efficacy
70	4000K	180mA	5.49 V	211 lm	213 lm/W
		360mA	5.74 V	409 lm	198 lm/W
		600mA	6.03 V	660 lm	182 lm/W
		640mA	6.08 V	700 lm	180 lm/W
		800mA	6.26 V	857 lm	171 lm/W
		880mA	6.35 V	929 lm	166 lm/W

Notes:

- 1) Reference Only

4. Outline Drawing & Dimension

a) Mechanical Dimensions

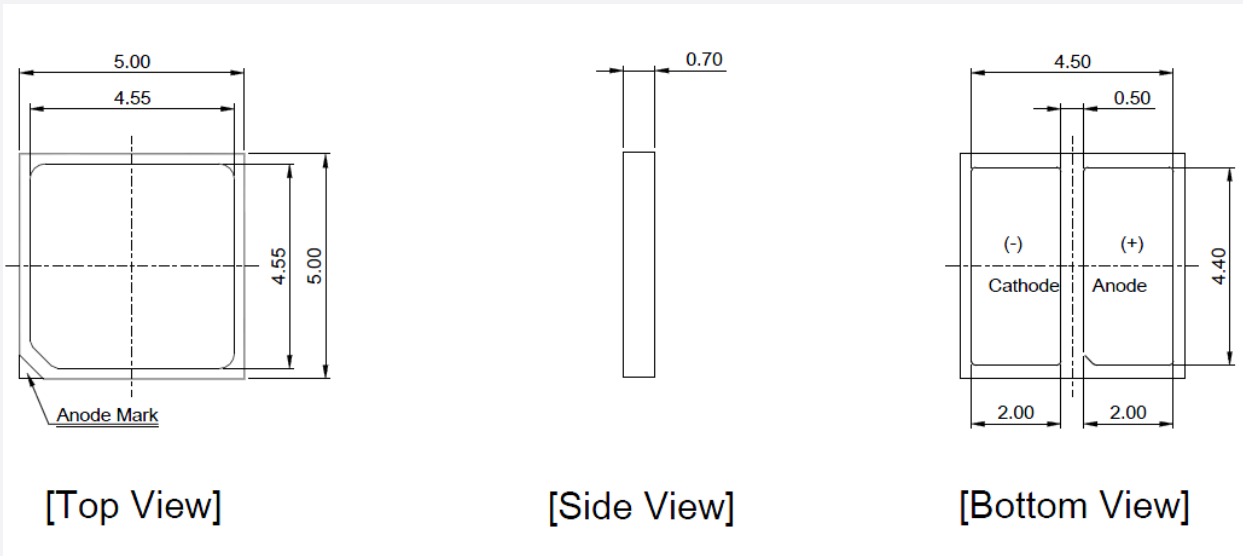

Notes:

- 1) Mark for the Anode
- 2) Unit : mm
- 3) Tolerance : $\pm 0.1\text{mm}$

b) Recommended Solder Pad

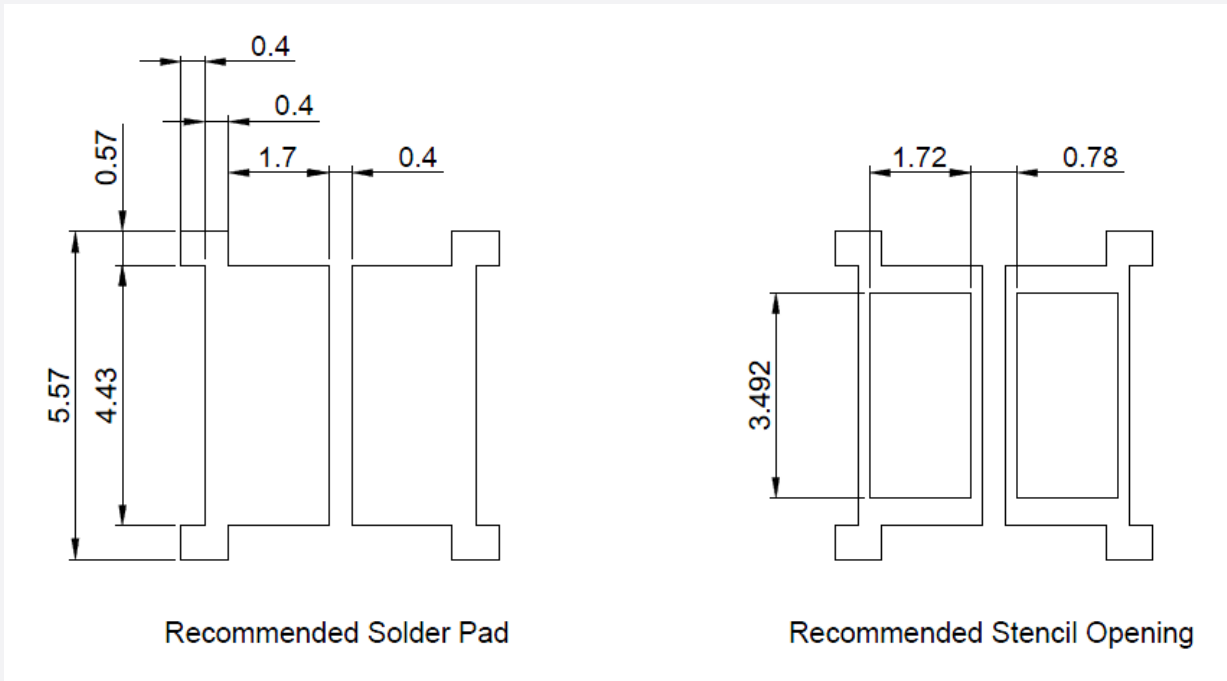

5. Reliability Test Items & Conditions

a) Test Items

Test Item	Test Condition	Test Hour / Cycle
High Temperature Operating Life Test	85°C, 440mA	1000 h
Wet High Temperature Operating Life Test	85°C, 85 % RH, DC 440mA	1000 h
Temperature Cycling	-45°C / 15min ~ 125°C / 15min Temperature change within 5min	500 cycles
ESD (HBM)	R1: 10 MΩ R2: 1.5 kΩ C: 100 pF V: ±2 kV	5 times
Vibration Test	20~ 80 Hz (displacement: 0.06 inch, max. 20 g) 80 ~ 2 kHz (max. 20 g) min. frequency ↔ max. frequency 4 min transfer	4 times
Mechanical Shock Test	1500g, 0.5 ms each of the 6 surfaces (3 axis x 2 sides)	5 times

b) Criteria for Judging the Damage

Item	Symbol	Test Condition (T _c = 25°C)	Limit	
			Min.	Max.
Forward Voltage	V _F	I _F = Sorting Current	L.S.L. * 0.9	U.S.L. * 1.1
Luminous Flux	Φ _v	I _F = Sorting Current	L.S.L. * 0.7	U.S.L. * 1.3

6. Soldering Conditions

a) Reflow Conditions (Pb free)

Reflow frequency: 2 times max.

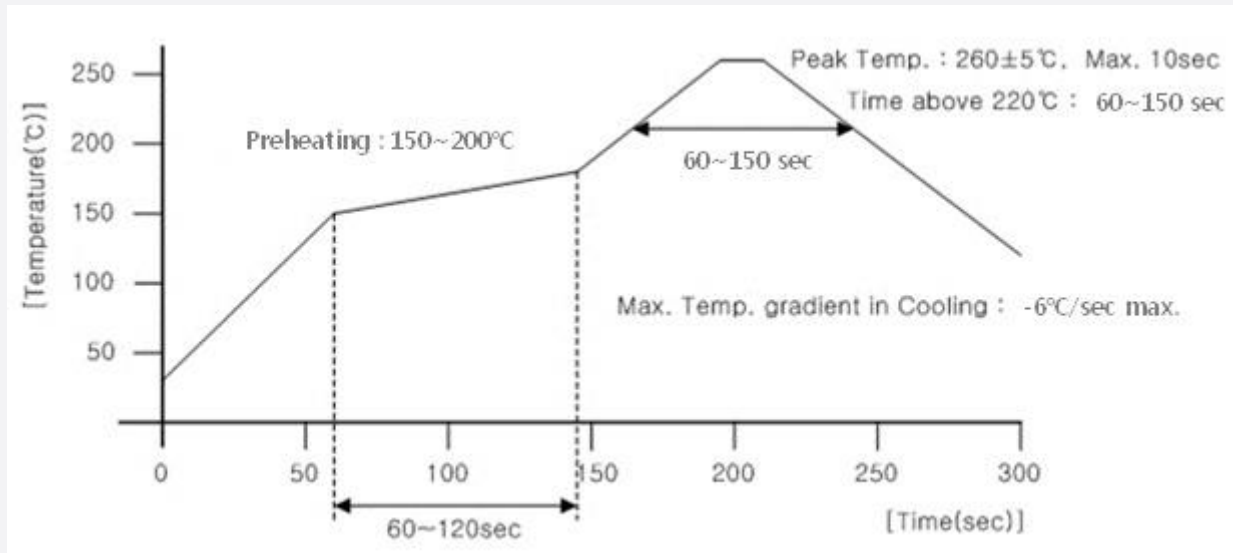

b) Manual Soldering Conditions

Not more than 5 seconds @ max. 300°C, under soldering iron.

7. Tape & Reel

a) Taping Dimension

(unit: mm)

ITEM	W	A0	B0	K0	E	F	D0	D1	P0	P1	P2	T	LENGTH	PCS/REEL
5.35	12.00	5.40	5.20	0.95	1.75	5.50	1.50	1.50	4.00	8.00	2.00	0.20	m	PCS

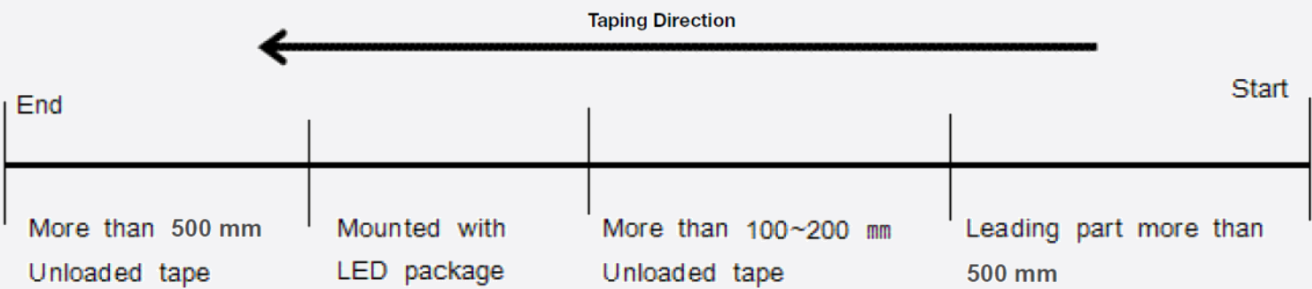
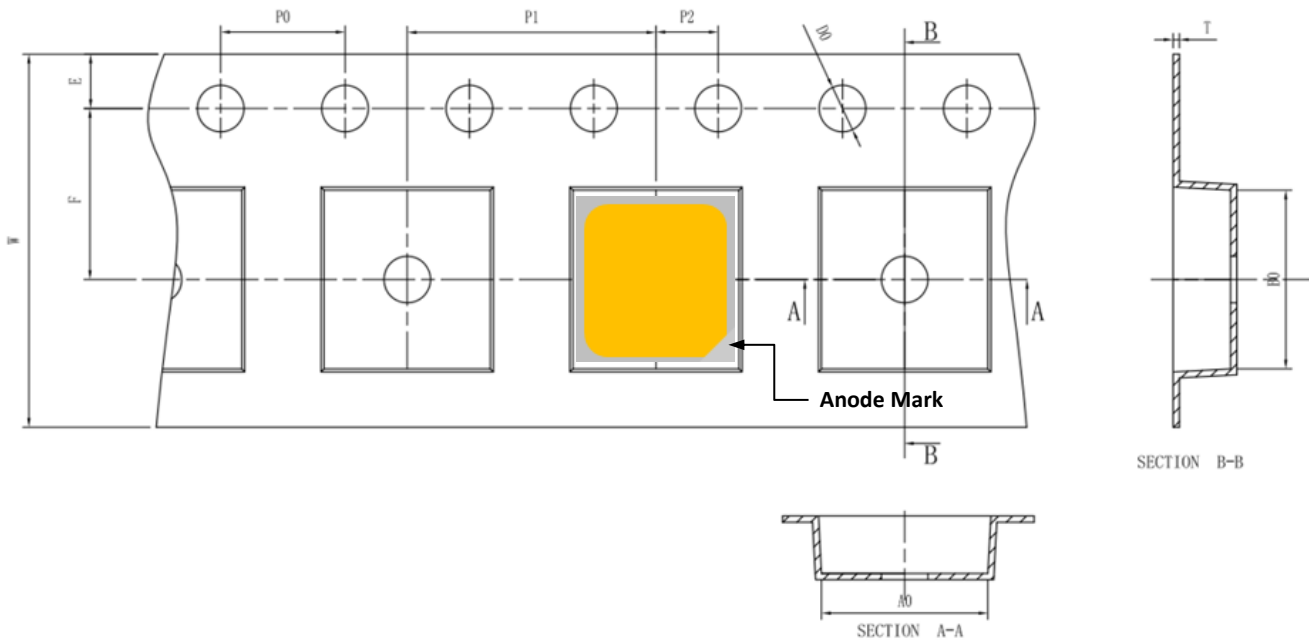

b) Reel Dimension (max 2,000 pcs)

(unit: mm)

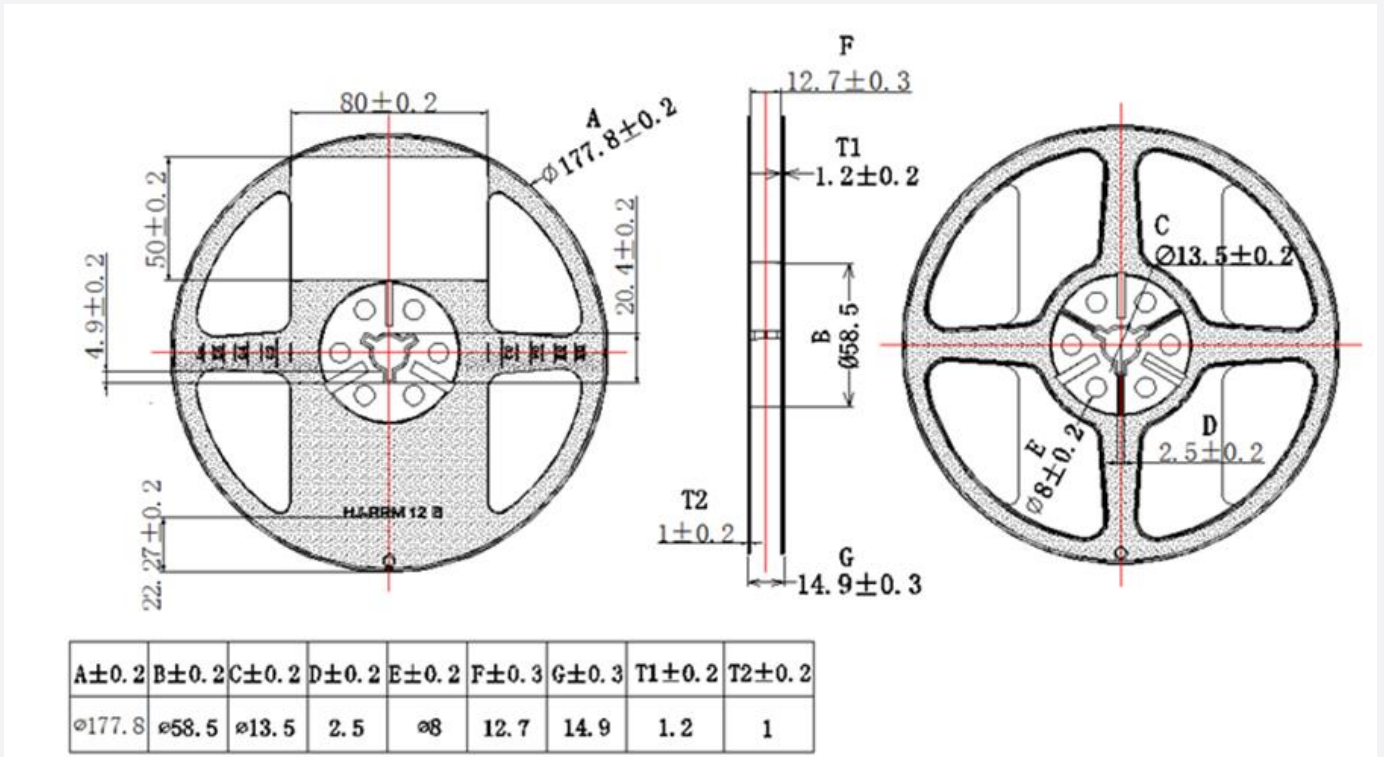

Notes:

- 1) Quantity: The quantity/reel is 2000 pcs
- 2) All dimensions are millimeters.
- 3) Packaging : P/N, Manufacturing data code no. and quantity are indicated on the aluminum packing bag.

8. Label Structure

a) Label Structure

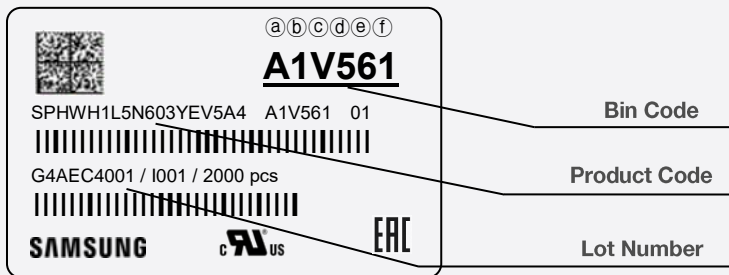

Note: Denoted bin code and product code above is only an example (see description on page 5)

Bin Code:

- ⒶⒷ: Forward Voltage bin (refer to page 7)
- ⒸⒹ: Chromaticity bin (refer to page 8)
- ⒺⒻ: Luminous Flux bin (refer to page 6)

b) Lot Number

The lot number is composed of the following characters:



①②③④⑤⑥⑦⑧⑨ / IⒶⒷⒸ / xxxx pcs

- ①② : Production site (G4 : Guangzhou ,China)
- ③ : Product state (A: Normal, B: Bulk, C: First Production, R: Reproduction, S: Sample)
- ④ : Year (G:2022, H:2023 ...)
- ⑤ : Month (1-9, A, B, C)
- ⑥ : Day (1-9, A, B-V)
- ⑦⑧⑨ : Samsung Electronics Product serial number (001 - 999)
- ⒶⒷⒸ : Reel number(001 - 999)

9. Packing Structure

a) Packing Process

Reel

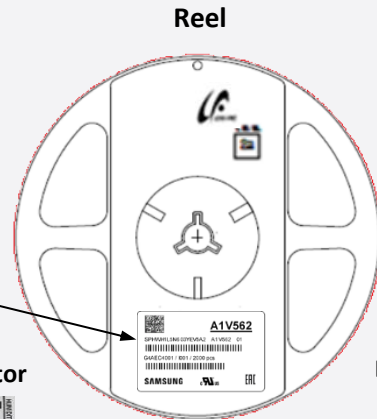
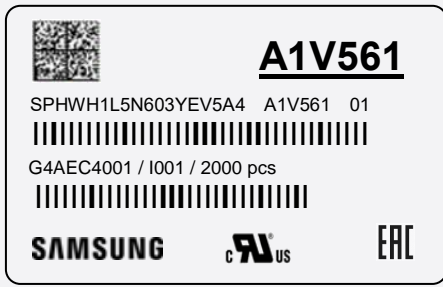

Humidity indicator



Desiccant



Aluminum Vinyl Packing Bag



Outer Box

Material: Paper (SW3B(B))

Type	Size (mm)			Note
	L	W	H	
7 inch S	245 ± 5	220 ± 5	86 ± 5	Up to 5 reels
7 inch L	245 ± 5	220 ± 5	182 ± 5	Up to 10 reels

Side Label

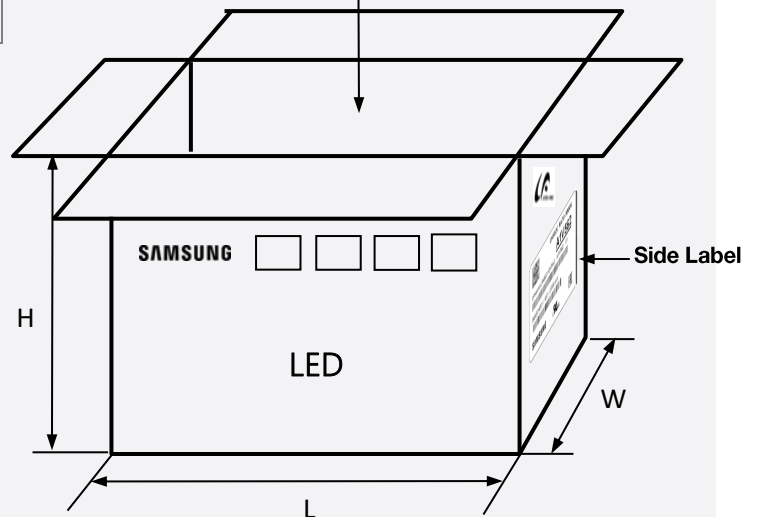

Paper(SW3B(B))

b) Aluminum Vinyl Packing Bag



CAUTION

This bag contains
MOISTURE SENSITIVE DEVICES

LEVEL
2a

1. Shelf life in sealed bag: 12 months at <math>< 40^{\circ}\text{C}</math> and <math>< 90\%</math> relative humidity (RH)
2. Peak package body temperature: 240 °C
3. After this bag is opened, devices that will be subjected to reflow solder or other high temperature processes must be:
 - a. Mounted within 672 hours at factory conditions of equal to or less than 30°C / 60% RH, or
 - b. Stored at <math>< 10\%</math> RH
4. Devices require bake, before mounting, if:
 - a. Humidity Indicator Card is >60% when read at 23±5°C, or
 - b. 2a is not met.
5. If baking is required, devices must be baked for 10 ~ 24 hours at 60±5°C

Note: If device containers cannot be subjected to high temperature or shorter bake times are desired, reference IPC/JEDEC J-STD-033 for bake procedure.

Bag seal due date: _____
(if blank, see code label)

Note: Level and body temperature by IPC/JEDEC J-STD-020



A1V561

SPHWH1L5N603YEV5A4 A1V561 01

|||||

G4AEC4001 / I001 / 2000 pcs

|||||

SAMSUNG

 **US**

ERC



LEAD-FREE





ATTENTION
OBSERVE PRECAUTIONS
FOR HANDLING
ELECTROSTATIC
SENSITIVE
DEVICES



OTHER

주의 사항

이 알루미늄 지퍼 백은 습기 및 정전기로부터 제품을 보호하기 위하여 제작되었습니다. 개봉 후에는 즉시 솔더 작업을 실시하는 것을 권장합니다.

습기 및 정전기로부터 제품을 보호 하기 위해서 개봉 후 사용하지 않는 자재는 본 팩에 넣어 보관 하시기 바랍니다. 사용하지 않는 자재를 본 팩에 넣을 때는 반드시 동봉된 드라이 팩과 함께 넣고 지퍼부분을 완전하게 밀봉하여 주시기 바랍니다.

Important

This Al Zipper bag is designed to protect the enclosed products from moisture and ESD. Once opened, the products should be soldered onto the printed circuit board immediately. When not in use, please do not leave the products unprotected by the Al Zipper Bag. To repack unused products., please ensure the zip-lock is completely sealed with the dry pack left inside.

c) Silica Gel & Humidity Indicator Card inside Aluminum Vinyl Bag

(This image is for reference only. Silicagel and humidity indicator shapes may be different.)

SILICA
GEL
THROWAWAY
"DO NOT EAT"

DESICCANT
SILICA
GEL

Complies with IPC/JEDEC J-STD-033 & REACH Regulation

COBALT DICHLORIDE FREE

HUMIDITY INDICATOR

10%

20%

30%

40%

50%

60%

READ AT LAVENDER COLOR
CHANGE BETWEEN BLUE AND PINK

Warning if pink
Change Desiccant

10. Precautions in Handling & Use

- 1) For over-current protection, users are recommended to apply resistors connected in series with the LEDs to mitigate sudden change of the forward current caused by shift of forward voltage.
- 2) This device should not be used in any type of fluid such as water, oil, organic solvent, etc. When cleaning is required, IPA is recommended as the cleaning agent. Some solvent-based cleaning agent may damage the silicone resins used in the device.
- 3) When the device is in operation, the forward current should be carefully determined considering the maximum ambient temperature and corresponding junction temperature.
- 4) LEDs must be stored in a clean environment. Shelf life of sealed bags is 12 months at temperature 0~40°C, 0~90 % RH.
- 5) After storage bag is opened, device subjected to soldering, solder reflow, or other high temperature processes must be:
 - a. Mounted within 672 hours (28 days) at an assembly line with a condition of no more than 30°C / 60 % RH, or
 - b. Stored at <10 % RH
- 6) Repack unused devices with anti-moisture packing, fold to close any opening and then store in a dry place.
- 7) Devices require baking before mounting, if humidity card reading is >60 % at 23 ± 5°C
- 8) Devices must be baked for 1 hour at 60 ± 5°C, if baking is required.
- 9) The LEDs are sensitive to the static electricity and surge current. It is recommended to use a wrist band or anti-electrostatic glove when handling the LEDs. If voltage exceeding the absolute maximum rating is applied to LEDs, it may cause damage or even destruction to LED devices. Damaged LEDs may show some unusual characteristics such as increase in leakage current, lowered turn-on voltage, or abnormal lighting of LEDs at low current.
- 10) VOCs (Volatile Organic Compounds) can be generated from adhesives, flux, hardener or organic additives used in luminaires (fixtures). Transparent LED silicone encapsulant is permeable to those chemicals and they may lead to a discoloration of encapsulant when they exposed to heat or light. This phenomenon can cause a significant loss of light emitted (output) from the luminaires. In order to prevent these problems, we recommend users to know the physical properties of materials used in luminaires and they must be carefully selected.
- 11) Risk of sulfurization (or tarnishing)

The LED from Samsung Electronics Co., Ltd. uses a silver-plated lead frame and its surface color may change to black (or dark colored) when it is exposed to sulfur (S), chlorine (Cl) or other halogen compound. Sulfurization of lead frame may cause intensity degradation, change of chromaticity coordinates and, in extreme cases, open circuit. It requires caution. Due to possible sulfurization of lead frame, LED should not be used and stored together with oxidizing substances made of materials such as: rubber, plain paper, lead solder cream, etc.

Legal and additional information.

[About Samsung Electronics Co., Ltd.](#)

Samsung Electronics Co., Ltd. inspires the world and shapes the future with transformative ideas and technologies, redefining the worlds of TVs, smartphones, wearable devices, tablets, cameras, digital appliances, printers, medical equipment, network systems and semiconductors.

We are also leading in the Internet of Things space through, among others, our Digital Health and Smart Home initiatives. We employ 307,000 people across 84 countries. To discover more, please visit our official website at www.samsung.com and our official blog at global.samsungtomorrow.com.

Samsung provides limited warranty for its LED products, the full text of which is available at <https://www.samsung.com/led/support/warranties>

Copyright © 2022 Samsung Electronics Co., Ltd. All rights reserved.

Samsung is a registered trademark of Samsung Electronics Co., Ltd.

Specifications and designs are subject to change without notice. Non-metric weights and measurements are approximate. All data were deemed correct at time of creation. Samsung is not liable for errors or omissions. All brand, product, service names and logos are trademarks and/or registered trademarks of their respective owners and are hereby recognized and acknowledged.

Samsung Electronics Co., Ltd.

95, Samsung 2-ro

Giheung-gu

Yongin-si, Gyeonggi-do, 446-711

KOREA

www.samsungled.com

SAMSUNG