

## Description

Single pole thermal circuit breaker with push-to-reset, tease-free, trip-free, snap action mechanism (R-type TO CBE to EN 60934), threadneck panel mounting. The optional -KF housing is particularly suited to high humidity and other damp conditions. Approved to CBE standard EN 60934 (IEC 60934).

## Typical applications

Motors, transformers, solenoids, extra low voltage wiring systems.

## Ordering information

### Type No.

**157** threadneck panel mounting (plastic knurled nut bulk shipped with 5 pcs plus)

### Terminal design

**P10** blade terminals A6.3-0.8 (QC .250)

**K10** screw terminals M4x6

### Housing

**KF** for tropical and high humidity conditions

### Current ratings

**0.05...25 A**

**157 - P10 - .. - 10 A** ordering example

Please be informed that we have minimum ordering quantities to be observed.

## Standard current ratings and typical internal resistance values

Current rating (A)	Internal resistance (Ω)	Current rating (A)	Internal resistance (Ω)
0.05	280	3	0.1
0.08	100	3.5	0.06
0.1	110	4	0.06
0.2	29	4.5	0.05
0.3	14	5	0.05
0.4	7	6	0.02
0.5	4.9	7	0.02
0.6	3.4	8	0.02
0.7	2.5	10	< 0.02
0.8	1.8	12	< 0.02
1	1.2	13	< 0.02
1.2	0.8	15	< 0.02
1.5	0.6	16	< 0.02
1.8	0.2	20	< 0.02
2	0.3	22	< 0.02
2.5	0.2	25	< 0.02



**157-...**

## Technical data

For further details please see: [www.e-t-a.de/ti\\_e](http://www.e-t-a.de/ti_e)

Voltage rating	AC 250 V; DC 28 V (UL: AC 250 V; DC 50 V)
Current ratings	0.05...25 A
Typical life	0.05...16 A 5,000 operations at 2 x I <sub>N</sub> , inductive 17...25 A 5,000 operations at 2 x I <sub>N</sub> , resistive
Ambient temperature	-20...+60 °C (-4...+140 °F)
Insulation co-ordination (IEC 60664 and 60664 A)	rated impulse withstand voltage 2.5 kV pollution degree 2 reinforced insulation in operating area
Dielectric strength (IEC 60664 and 60664A) operating area	test voltage AC 3,000 V
Insulation resistance	> 100 MΩ (DC 500 V)
Interrupting capacity I <sub>cn</sub>	0.05...2.5 A 8 x I <sub>N</sub> 3...5 A 20 x I <sub>N</sub> 6...12 A 200 A 13...25 A 300 A
Interrupting capacity (UL 1077)	I <sub>N</sub> U <sub>N</sub> 0.05...20 A AC 250 V 2,000 A 0.05...25 A DC 50 V 2,500 A
Degree of protection (IEC 60529/DIN 40050)	operating area IP40 terminal area IP00
Vibration	8 g (57-500 Hz) ± 0.61 mm (10-57 Hz) to IEC 60068-2-6, test Fc, 10 frequency cycles/axis
Shock	25 g (11 ms) to IEC 60068-2-27, test Ea
Corrosion	96 hours at 5 % salt mist, to IEC 60068-2-11, test Ka
Humidity	240 hours at 95 % RH to IEC 60068-2-78, test Cab
Mass	approx. 24 g

## Approvals

Authority	Standard	Rated voltage	Current ratings
VDE	IEC / EN 60934	AC 250 V DC 28 V	0.05 A...25 A 0.05 A...20 A
UL	UL 1077	AC 250 V DC 50 V	0.05 A...20 A 0.05 A...25 A
CSA	C22.2 No 235	AC 250 V DC 50 V	0.1 A...20 A 0.1 A...25 A
CQC	GB 17701	AC 250 V DC 28 V	0.05 A...25 A 0.05 A...25 A

## Dimensions

### 157-P10

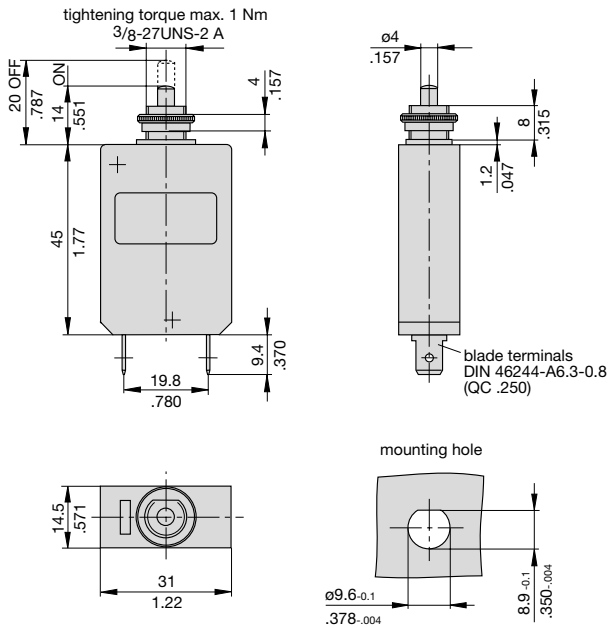

### 157-K10

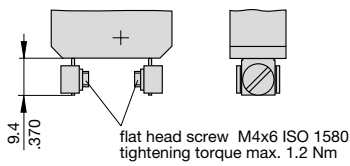

## Internal connection diagram

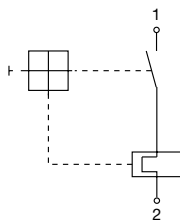

## Typical time/current characteristics at +23 °C/+73.4 °F

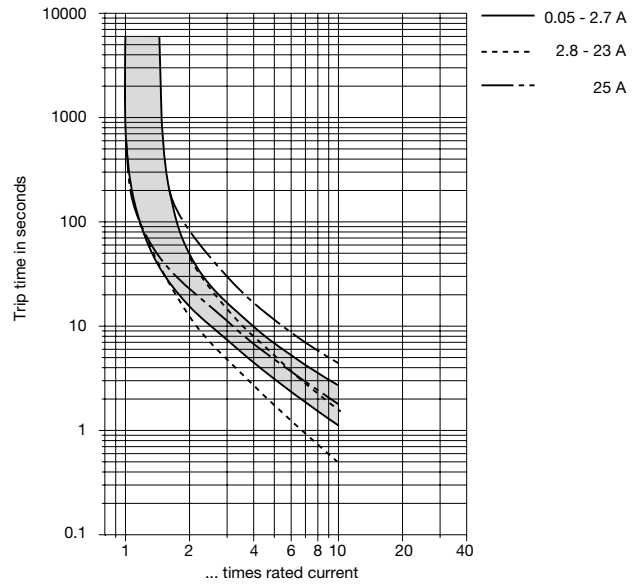

The time/current characteristic curve depends on the ambient temperature prevailing. In order to eliminate nuisance tripping, please multiply the circuit breaker current ratings by the derating factor shown below. See also section Technical information.

Ambient temperature °F	-4	+14	+32	+73.4	+104	+122	+140
°C	-20	-10	0	+23	+40	+50	+60
Derating factor	0.76	0.84	0.92	1	1.08	1.16	1.24

## Installation drawings

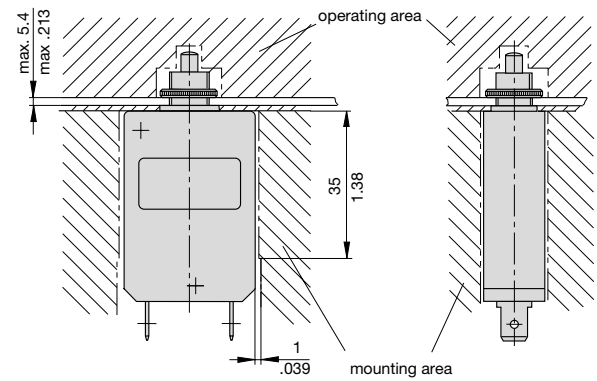

This is a metric design and millimeter dimensions take precedence (mm/inch)

## Accessories

### Mounting sockets 10F-P10 (up to 16 A max. load)

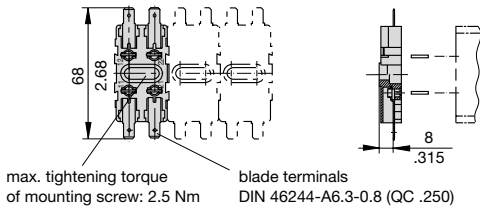

### 10F-K10 (up to 20 A max. load)

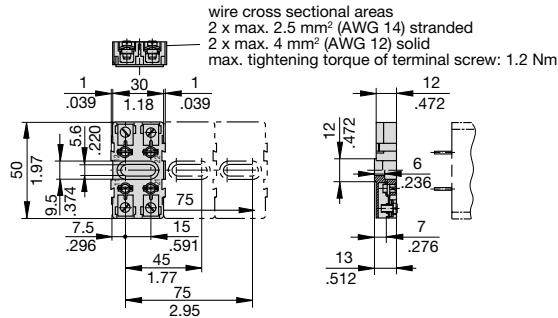

### 10F-A10 (up to 16 A max. load)

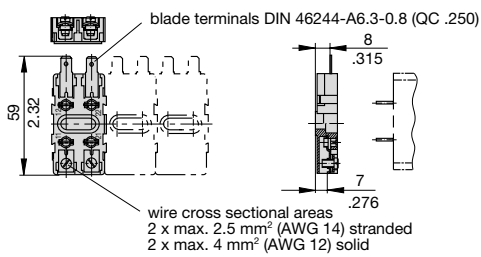

### Accessories for sockets (up to 20 A max. load) 2-way bus bar Y 301 166 02 4-way bar Y 301 166 01

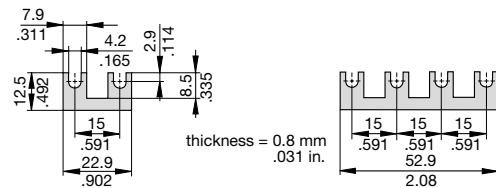

### Connector bus links -K10

X 210 589 01/ 2.5 mm<sup>2</sup> (AWG 14), black (up to 20 A max. load)  
X 210 589 02/ 1.5 mm<sup>2</sup> (AWG 16), brown (up to 13 A max. load)

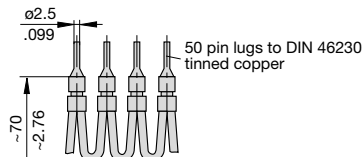

### Connector bus links -P10

X 210 588 01/ 1.5 mm<sup>2</sup> (AWG 16), brown (up to 13 A max. load)  
X 210 588 02/ 2.5 mm<sup>2</sup> (AWG 14), black (up to 20 A max. load)  
X 210 588 03/ 2.5 mm<sup>2</sup> (AWG 14), red (up to 20 A max. load)  
X 210 588 04/ 2.5 mm<sup>2</sup> (AWG 14), blue (up to 20 A max. load)

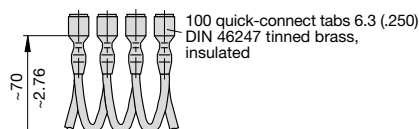

### Front panel water splash cover, transparent Y 300 538 01 and knurled nut Y 300 628 01 X 200 799 01 (bonded to nut) (IP64)

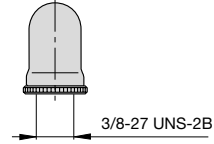

### Front panel water splash cover, transparent with special knurled nut X 200 798 02 (bonded to nut) (IP64)

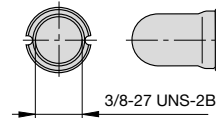

### Splash cover (black) with hex nut (IP64) X 210 739 01

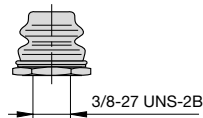

### Knurled nut 3/8" plastic (standard) Y 307 117 02

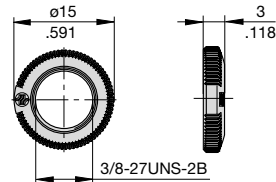

This is a metric design and millimeter dimensions take precedence ( $\frac{\text{mm}}{\text{inch}}$ )

All dimensions without tolerances are for reference only. In the interest of improved design, performance and cost effectiveness the right to make changes in these specifications without notice is reserved. Product markings may not be exactly as the ordering codes. Errors and omissions excepted.

