



TAOGLAS®



Datasheet

DXP.01.A

Description:

SMD L1/L2 SAW Diplexer for GPS/GALILEO L1, GLONASS L2 & BeiDou B2

Features:

SAW Diplexer SMT Direct Mount

L2 1227.6 / L1 1575.42MHz

Low Insertion Loss In band

High Isolation Port to Port

Compact Size: 5 * 5 * 1.7 mm

RoHS & Reach Compliant

1. Introduction	3
2. Specifications	4
3. Measurement Circuit	5
4. Mechanical Drawing	9
5. Integration Guide	10
6. Recommended Reflow Profile	14
7. Packaging	15
<hr/>	
Changelog	16

Taoglas makes no warranties based on the accuracy or completeness of the contents of this document and reserves the right to make changes to specifications and product descriptions at any time without notice. Taoglas reserves all rights to this document and the information contained herein. Reproduction, use or disclosure to third parties without express permission is strictly prohibited.



1. Introduction



The Taoglas DXP.01.A is a compact SAW diplexer for use in any navigation system application using the GPS/GALILEO L1, GLONASS L2 and BeiDou B2 bands.

The diplexer is designed to function as both a bandpass filter for each band and to either split one path into three or to combine the bands back into one RF feed. For example, a customer who wanted to use passive antenna elements would need to implement a diplexer in some cases to split the bands out into separate paths. It is also designed to isolate and reject any unwanted GPS/GALILEO signals from getting to the application port.

It is housed in a compact 5*5*1.7mm over-molded laminate package and is easy to integrate using SMD process mounting directly onto the target PCB.

For further optimization to customer-specific device environments and for support to integrate and test this antennas performance in your device, contact your regional Taoglas Customer Services Team.

2. Specifications

L1 Band GPS/GALILEO			
	Min.	Typ.	Max.
Center Frequency (MHz)	-	1575.42	-
Insertion Loss (dB)	-	3.3	3.8
Amplitude Ripple (dB)	-	0.1	1.0
Return Loss (dB)	-	-12	-8.5
Attenuation (Reference level from 0dB)			
824 ~ 960 (MHz)	25	47	-
1500 ~ 1525.42 (MHz)	8	19	-
1625.42 ~ 1650 (MHz)	8	16	-
1710 ~ 2170 (MHz)	25	34	-
L2 Band GLONASS and B2 Band BeiDou			
	Min.	Typ.	Max.
Center frequency (MHz)	-	1227.625	-
Insertion Loss (dB)	-	4.1	4.8
Amplitude Ripple (dB)	-	0.9	1.8
Return Loss (dB)	-	-12	8.5
Attenuation (Reference level from 0dB)			
464 ~ 600 (MHz)	25	32	-
1110 ~ 1130 (MHz)	16	23	-
1330 ~ 1450 (MHz)	28	37	-
1500 ~ 1820 (MHz)	25	30	-
L1 Band GPS/GALILEO, L2 Band GLONASS and B2 Band BeiDou			
	Min.	Typ.	Max.
Isolation (1196.9~1248.625MHz)	22	36	-
Isolation (1574.22~1576.62 dB)	22	33	-
Environmental			
Operating Temperature	-40°C to 85°C		
Storage Temperature	-40°C to 85°C		
Input power Level	10 dBm		
DC Voltage	3 V		
Moisture Sensitivity Level (MSL)	1		

3. Measurement Circuit

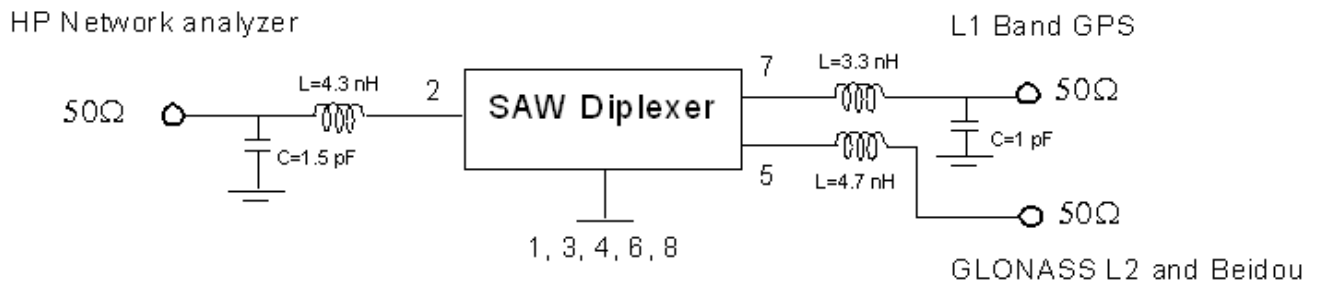

3.1 Test Setup

Band 1 (L1) **Band 2(L2/L5)**



Common Port

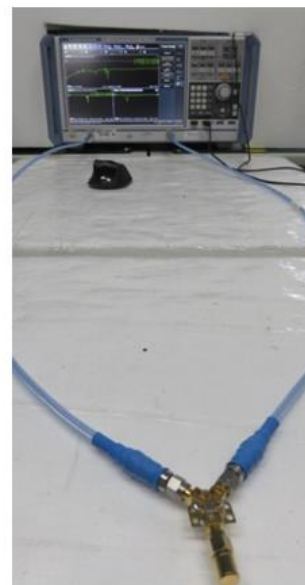

3.2 Return Loss

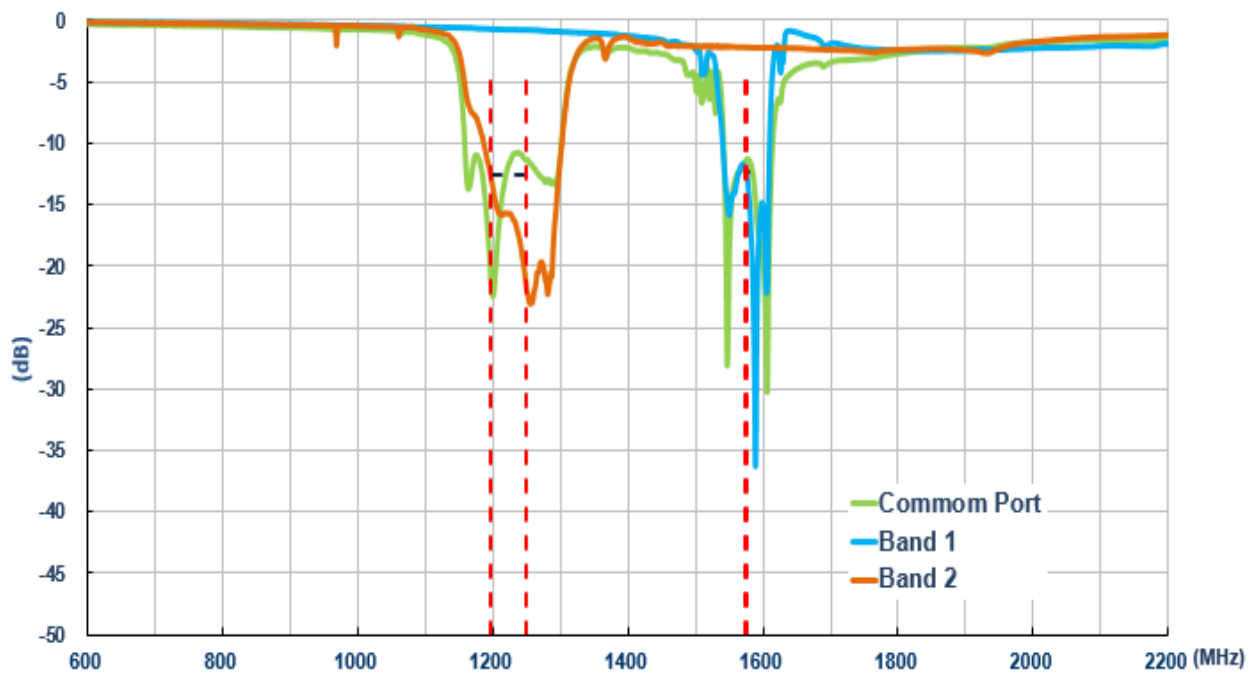

3.3 Common Port to Band 1 Port _ 1575.42MHz Attenuation

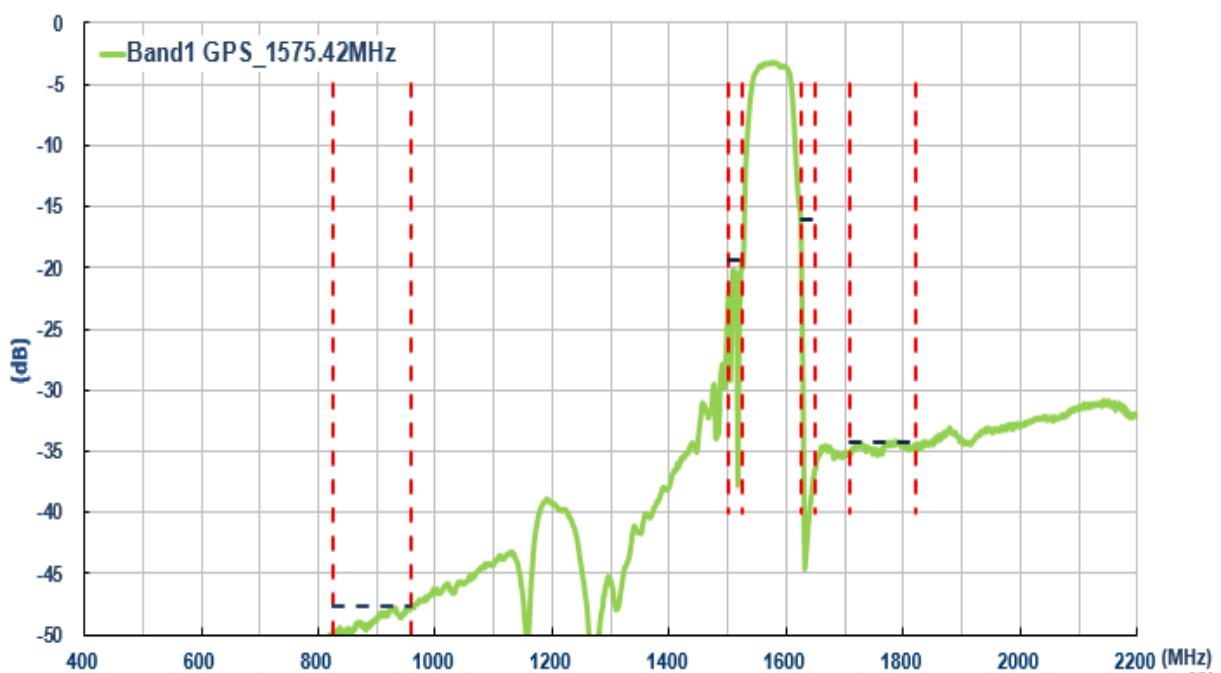

3.4 Common Port to Band 1 Port _ 1575.42MHz Insertion Loss

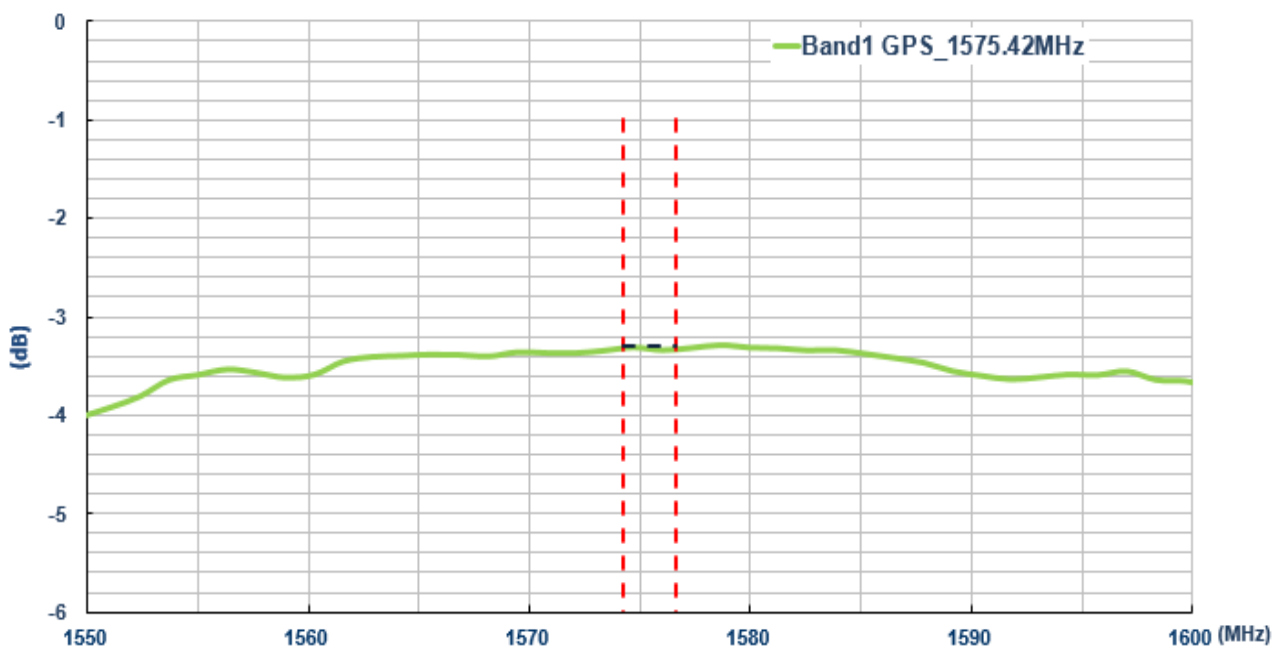

3.4 Common Port to Band 1 Port _ 1227.6MHz Attenuation

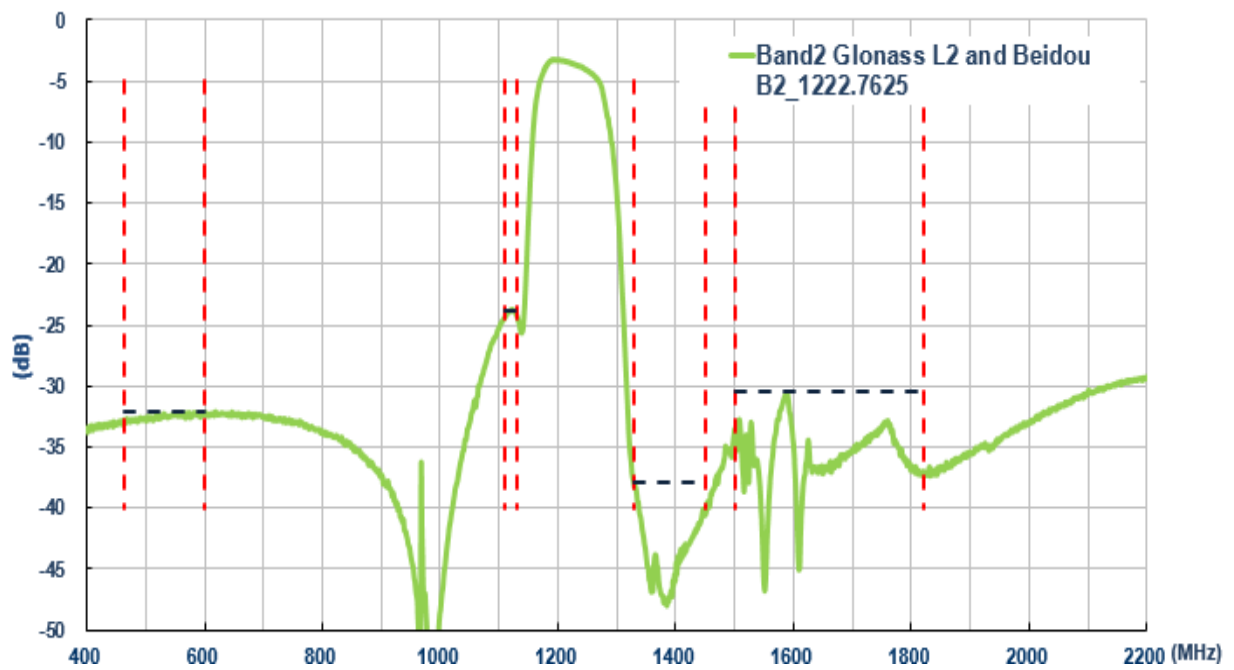

3.5 Common Port to Band 2 Port _ 1227.6MHz Insertion Loss

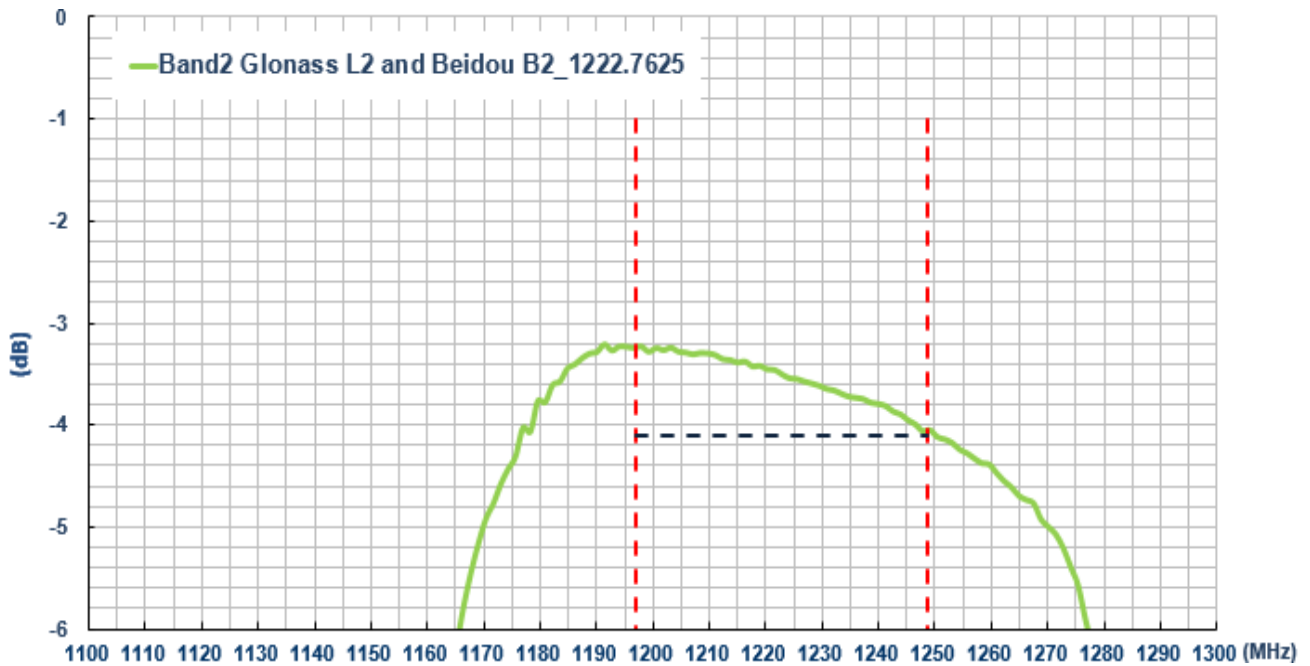

3.6 Band 1 Port – Band 2 Port Isolation

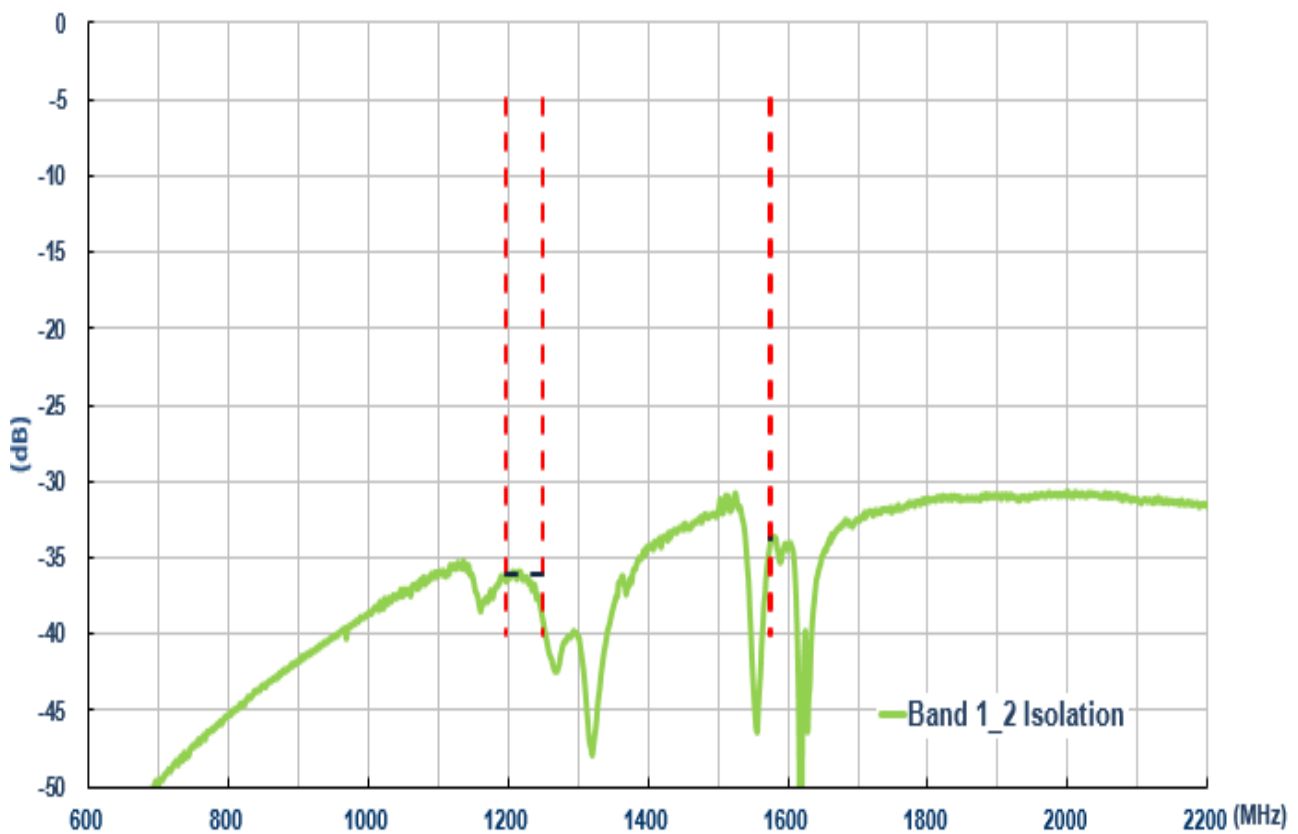

4. Mechanical Drawing (Units: mm)

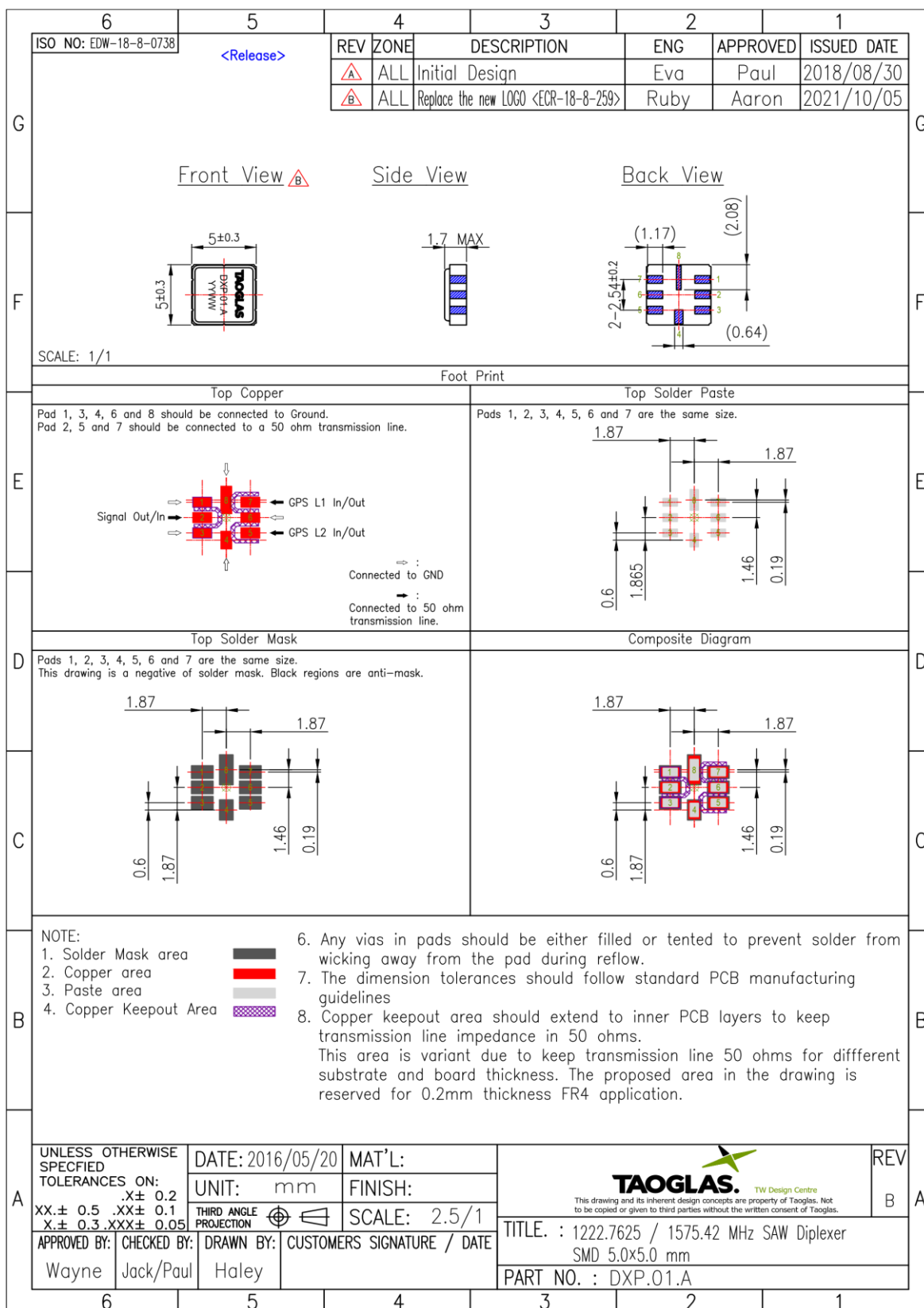

5. Integration Guide

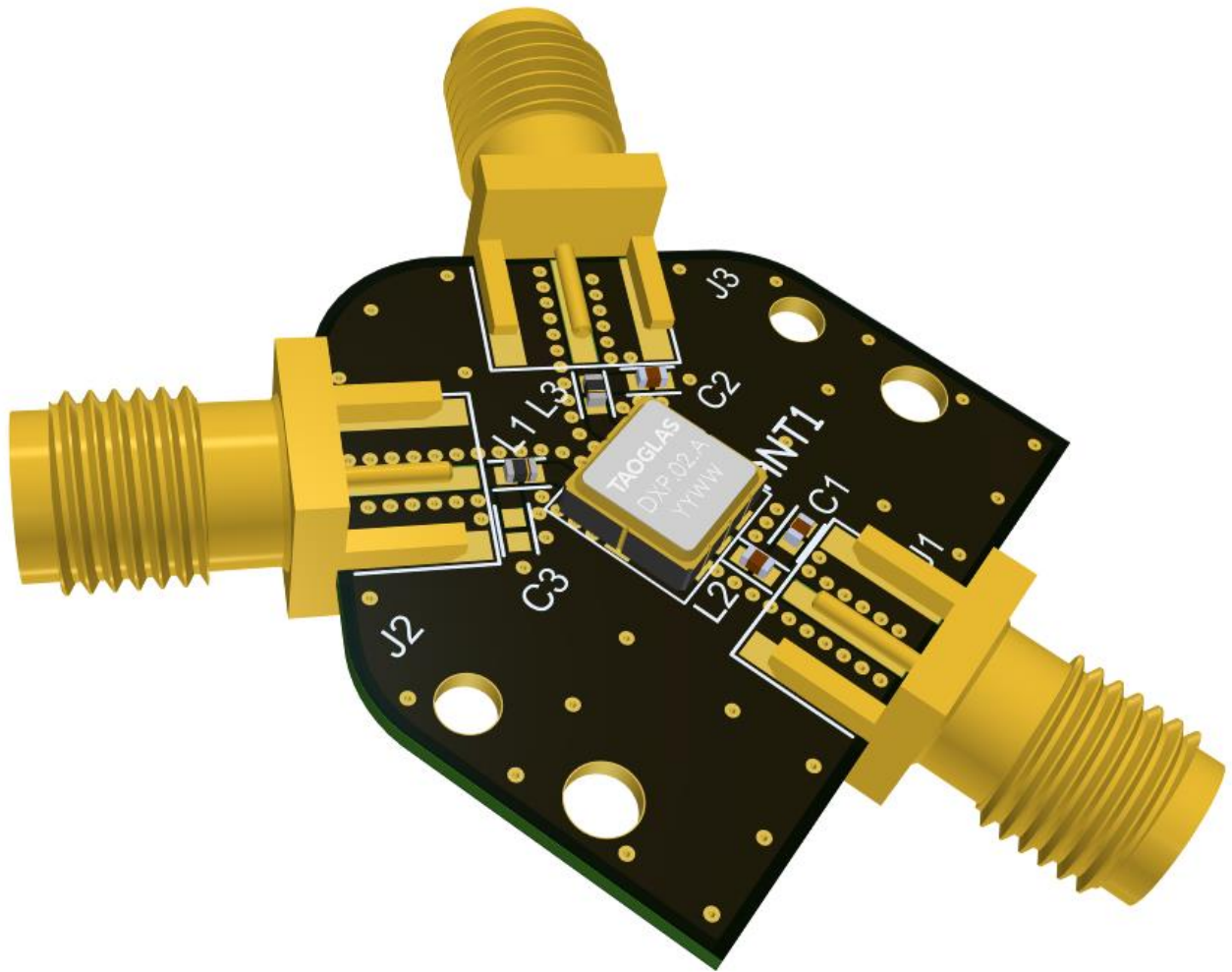

5.1 Schematic Symbol and Pin Definition

The circuit symbol for the SAW Diplexer is shown below. The SAW Diplexer has 8 pins as indicated below. The L1 pin represents the higher GNSS frequency bands at 1559 - 1610MHz and the L2 pin represents the lower GNSS frequency bands at 1164 - 1300MHz, including L5, E5a and E5b bands.

Pin	Description
2	Signal Input
5	GPS L1 Output
7	GPS L1/L2 Output
1, 3, 4, 6, 8	Ground

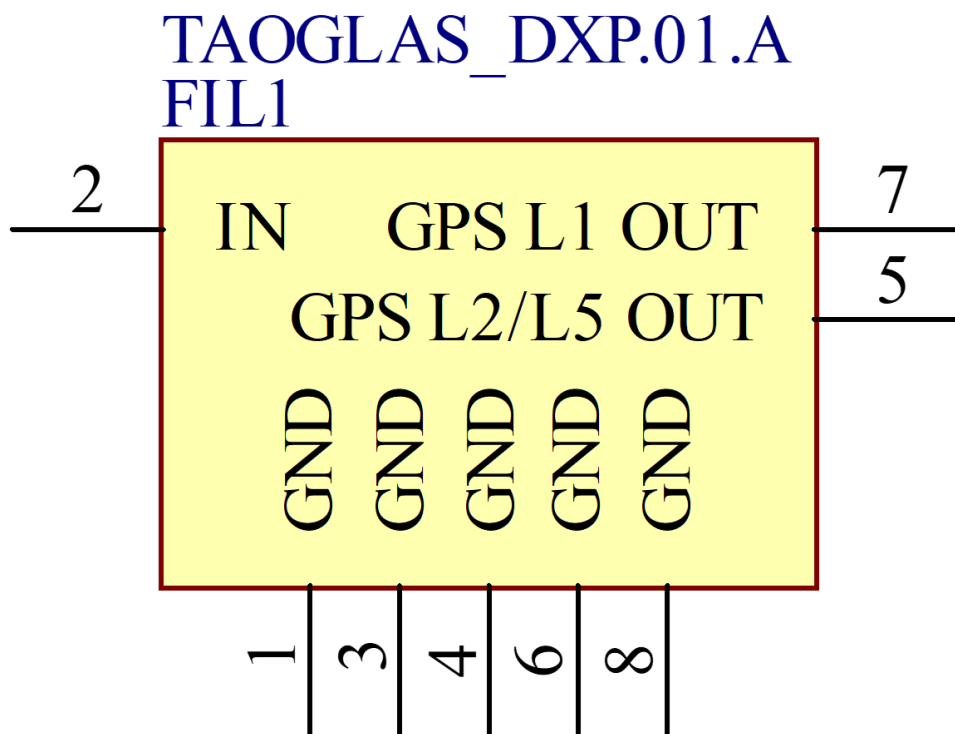

5.2 SAW Diplexer Integration Guide

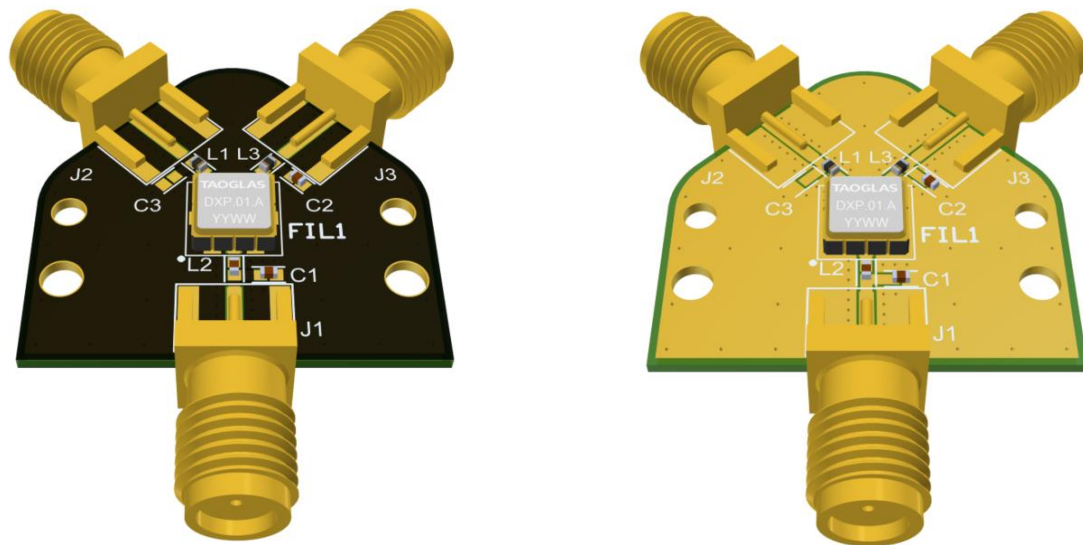

5.3 PCB Layout

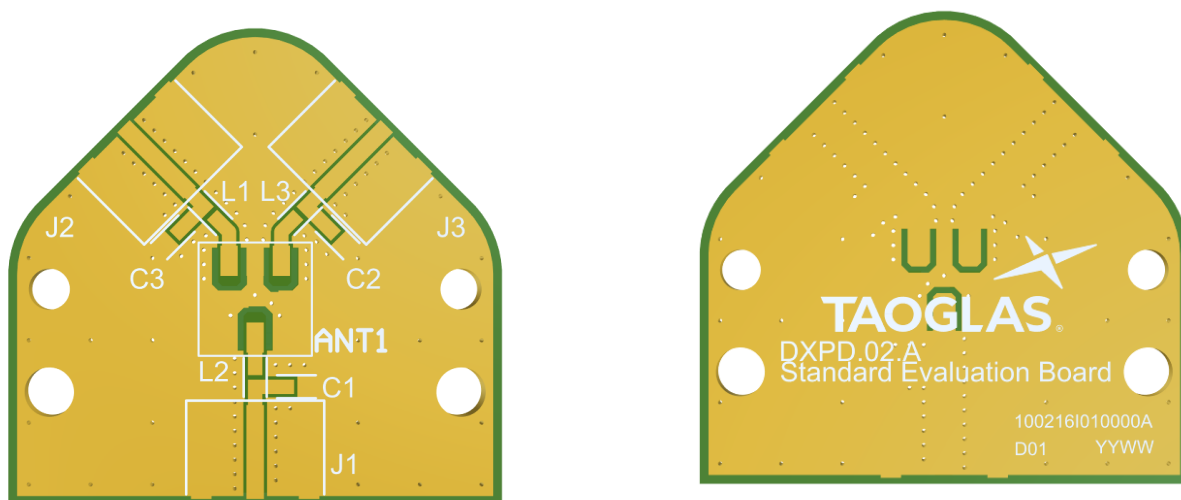

5.4 Evaluation Board Matching Circuit

Each patch element uses two orthogonal feeds that need to be combined in a Saw Diplexer to ensure optimal axial ratio. Taoglas recommends our DXP.01, a high-performance Saw Diplexer specifically engineered for use with our multi feed patches.

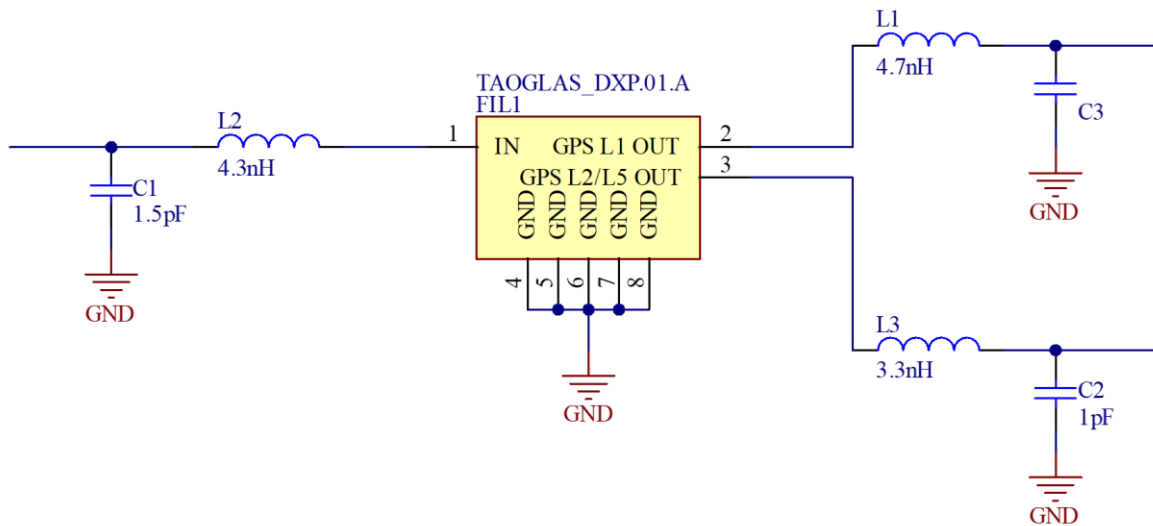

Designator	Type	Value	Manufacturer
L1	Inductor	4.7nH	TDK
L2	Inductor	4.3nH	TDK
L3	Inductor	3.3nH	TDK
C1	Capacitor	1.5pF	Murata
C2	Capacitor	1pF	Murata
C2	Capacitor	Not Fitted	-

6. Recommended Reflow Profile

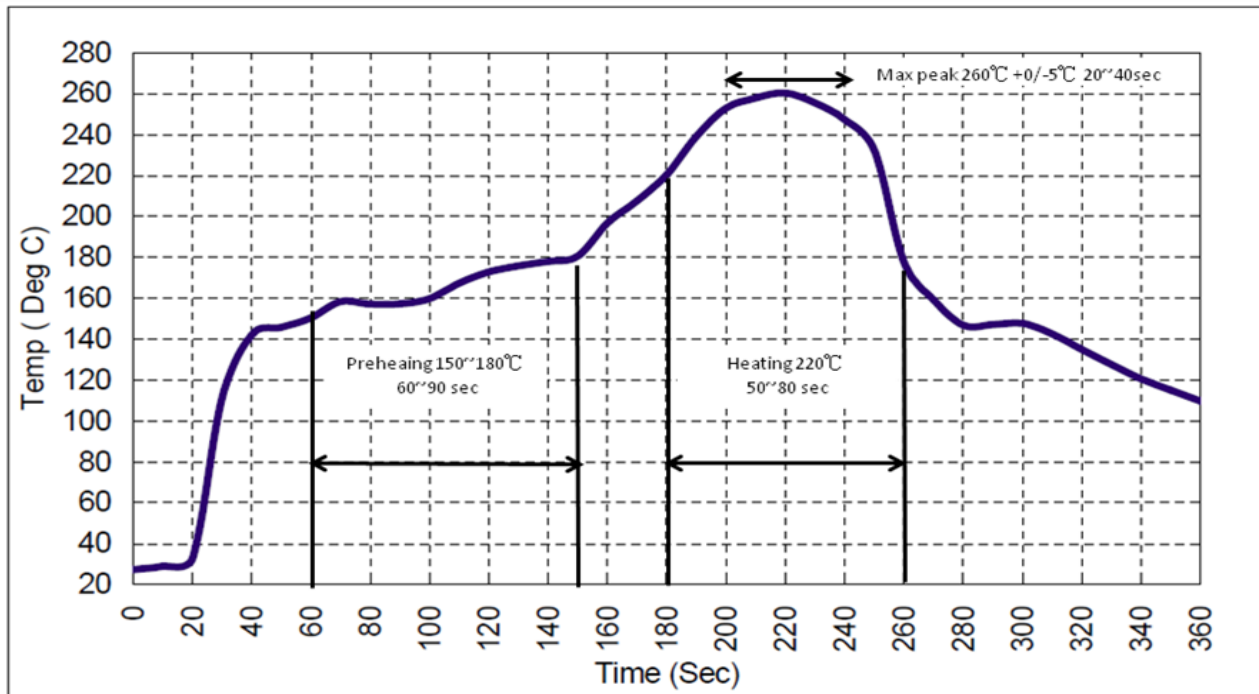

1. Preheating shall be fixed at 150~180°C for 60~90 seconds.
2. Ascending time to preheating temperature 150°C shall be 30 seconds minimum.
3. Heating shall be fixed at 220°C for 50~80 seconds and 260°C as the peak for 20-40 seconds.
4. Time: 2 times.

7. Packaging

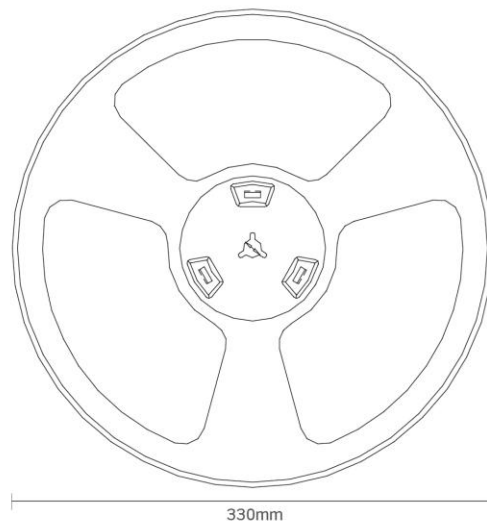
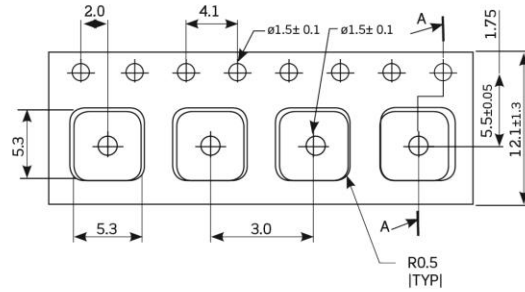

1000 pcs DXP.01 reel
 Dimensions - 330*12mm
 Weight - 0.2g

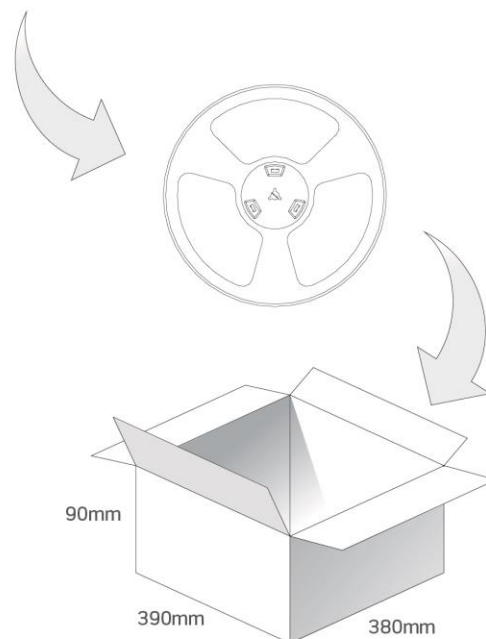

4 reels / 4000 pcs
 in one carton
 Carton Dimensions - 390*380*90mm
 Weight - 1.3Kg

Changelog for the datasheet

SPE-17-8-006 – DXP.01.A

Revision: D (Current Version)	
Date:	2023-01-23
Changes:	Updated MSL and drawing
Changes Made by:	Cesar Sousa

Previous Revisions

Revision: D	
Date:	2022-08-23
Changes:	Updated MSL and drawing
Changes Made by:	Cesar Sousa

Revision: C	
Date:	2022-08-02
Changes:	Added EVB drawing
Changes Made by:	Cesar Sousa

Revision: B	
Date:	2021-10-05
Changes:	Updated MSL and drawing
Changes Made by:	Jack Conroy

Revision: A (Original First Release)	
Date:	2017-01-25
Notes:	Initial Specification Release
Author:	Jack Conroy



TAOGLAS®

www.taoglas.com

