

Bridgetek Pte Ltd

Datasheet

MM930Mini Module

High Speed USB-Serial

MCU Development Module

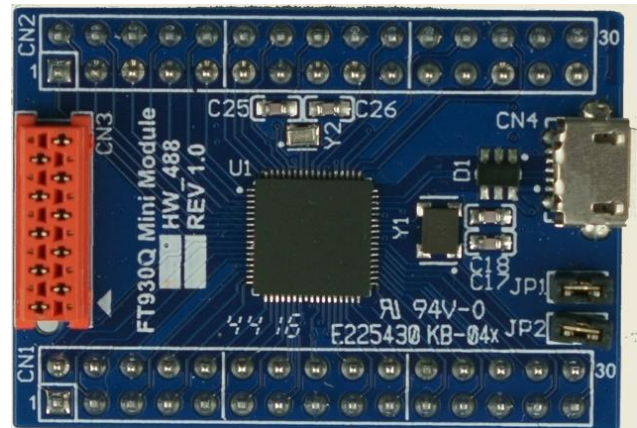

1 Introduction

The MM930Mini Module is a USB microcontroller development module in the Bridgetek product range. It utilizes the FT930Q bridge chip which can handle all USB signalling and protocols. It is ideal for development purposes to quickly prove functionality of adding USB to a target design. Refer to [DS_FT930_1_2_3](#) datasheet for details.

1.1 Features

- USB 2.0 Hi-Speed compatible
- Reduced development time
- Rapid integration into existing systems
- USB powered – no external power supply needed
- Based on the USB Hi-Speed FT930Q device
- Entire USB protocol handled by D2xx hardware engine
- USB micro-B connector common on many commercial devices
- On-board 500mA 3.3V LDO regulator, 12MHz crystal, 32kHz crystal.
- Asynchronous Serial data transfer rates from 300 baud to 12 Mbaud at TTL levels
- One SPI master supports single / dual / quad modes of data transfer. Clock rate is up to 25 MHz
- One SPI slave support single data transfer with 25MHz clock
- I2C bus interface can be configured as master or slave, with data transfers up to 3.4Mbps
- Support for USB suspend and resume
- UHCI / OHCI / EHCI host controller compatible
- -40°C to +85°C operating temperature range

Neither the whole nor any part of the information contained in, or the product described in this manual, may be adapted or reproduced in any material or electronic form without the prior written consent of the copyright holder. This product and its documentation are supplied on an as-is basis and no warranty as to their suitability for any particular purpose is either made or implied. Bridgetek Pte Ltd will not accept any claim for damages howsoever arising as a result of use or failure of this product. Your statutory rights are not affected. This product or any variant of it is not intended for use in any medical appliance, device or system in which the failure of the product might reasonably be expected to result in personal injury. This document provides preliminary information that may be subject to change without notice. No freedom to use patents or other intellectual property rights is implied by the publication of this document. Bridgetek Pte Ltd, 178 Paya Lebar Road, #07-03, Singapore 409030. Singapore Registered Company Number: 201542387H

2 Module Description

The FT930 on the Mini Module is a Bridgetek RISC microcontroller device with a D2xx¹ hardware engine. The D2xx hardware engine makes it easy to create bridge applications to a variety of FT930 peripherals such as UART, SPI, I²C, SD-Host, PWM and so on. The FTD2xx library simplifies software application development.

The FT930 device features two full UARTs or four simple UARTs, Quad SPI master, SPI slave, SD-Host controller, I²C, four 16-bit timers, one 32-bit watchdog timer, 8 PWMs, two 10-bit DACs, 3-channel 8-bit ADC, and a high speed USB 2.0 peripheral controller. All components used, including the MM930Mini are Pb-free (RoHS compliant).

The MM930Mini Module connects the pins from the FT930 IC to two 30-way dual-row pin headers. Each header is grouped in sets of 10-pins by the top silkscreen for easy pin counting. The 30-way pin header allows easy connection to PCB header sockets and ribbon cables.

The MM0930Mini Module is preloaded with a sample program. The sample program demonstrates the use of the D2xx hardware engine. The D2xx hardware engine is configured to operate four D2xx interfaces. The sample program bridges each of the D2xx interfaces to a UART.

When the module is first attached to a Windows PC, D2xx device drivers are automatically installed from Windows Update. At the end of the installation, four FT930 Serial Ports will be installed in the system. In case of Windows 7, manual update from Windows Update has to be selected. For other OSes, driver and library support is available from [FTDI Drivers](#).

Figure 1-2 illustrates a way to access the D2xx UART bridge.

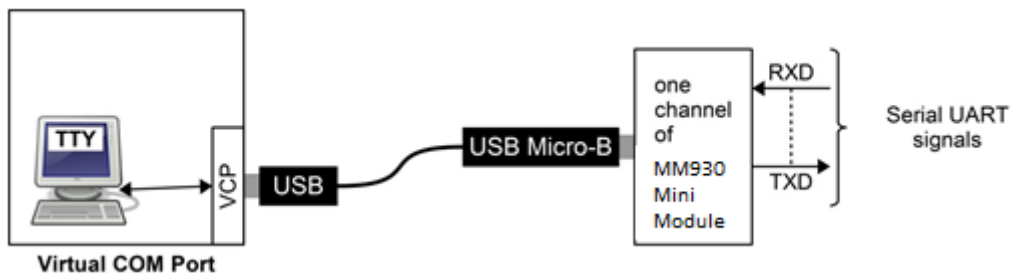

Figure 2-1 Using the MM930Mini Module VCOM

Additionally, the user can communicate via Standard USB Class Drivers with the FT930 in non-D2xx mode, with the MM930Mini Module working as a BOMS/HID/CDC device as shown in Figure 2-2. Example programs that implement these device classes are available from FT9xx Toolchain V2.3.0 and later versions.

¹ Used under agreement between BRT and FTDI, D2xx is the popular FTDI USB driver used on its FT2xx USB UART/FIFO Bridge platforms. It can be accessed directly or through a virtual COM port.

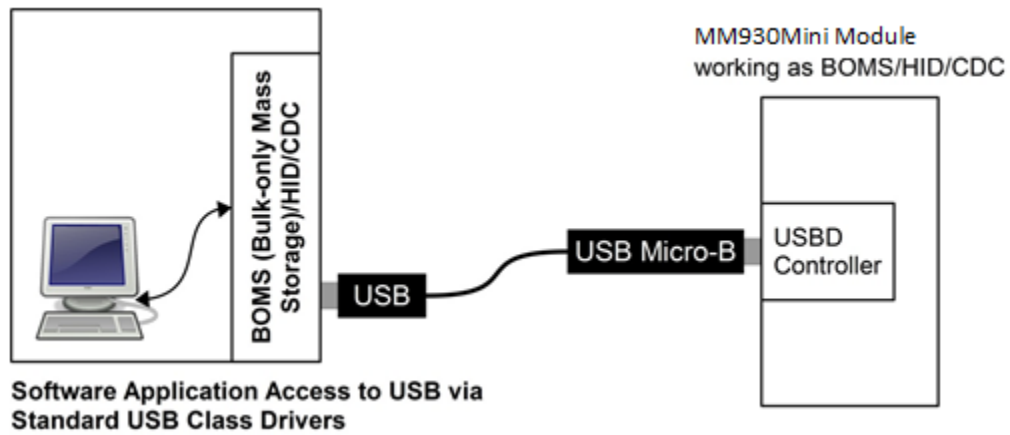

Figure 2-2 Using the MM930Mini Module as BOMS/HID/CDC

Device Drivers for the MM930Mini Module are available free from <http://brtchip.com/firmware/>.

Table of Contents

1	Introduction	1
1.1	Features.....	1
2	Module Description	2
3	Typical Applications	5
3.1	Driver Support	5
4	Electrical Details	6
4.1	Power Supply Configuration.....	9
5	Mechanical Details	10
6	Schematic Diagram	11
7	Contact Information.....	12
	Appendix A – References	10
	Document References	10
	Acronyms and Abbreviations.....	10
	Appendix B – List of Tables & Figures	11
	List of Tables.....	11
	List of Figures	11
	Appendix C – Revision History	12

3 Typical Applications

- Rapid USB integration into existing electronic systems.
- Prototyping platform for USB interface on new systems.
- USB to SPI, I²C, SD-Card, PWM Audio, ADC, and DAC interfaces.
- USB to multi-port asynchronous serial interfaces (up to 4 ports available).
- GPIOs may be used freely to implement any bridging protocol.

3.1 Driver Support

Refer to [FTDI Drivers](#) for up-to-date driver support information.

4 Electrical Details

The electrical details and connections to the MM930Mini Module are shown in Figure 3.1 and Table 3.1 to Table 4-3.

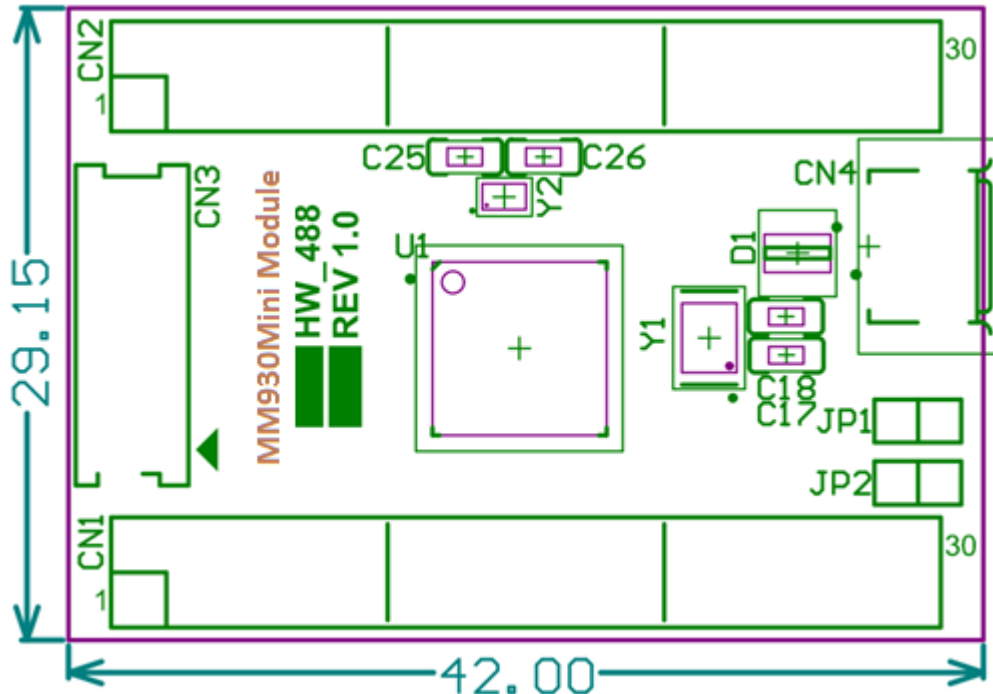

Figure 4-1 MM930Mini Module Electrical Connections (Top View)

Connector	Name	Description
JP1	VBUS to 5V jumper	Connects VBUS to input of regulator.
JP2	Regulator 3.3V to FT930 3.3V jumper	Connects output of regulator to 3.3V rail.
CN1	30-way I/O pin header	Power & I/O signals. See Table 4-2.
CN2	30-way I/O pin header	Power & I/O signals. See Table 4-3.
CN3	Programming Interface	Interface to UMFTPD2A module. To program and debug firmware running on the FT93x series.
CN4	USB micro-B connector	Hi-Speed USB port to FT930.

Table 4-1 MM930Mini Module Connectors

Connector Pin	Name	Description
CN1-1	DTR_UART0	FT930Q UART0_DTR/UART1_RXD/GPIO26
CN1-2	DSR_UART0	FT930Q UART0_DSR/UART1_TXD/GPIO27
CN1-3	DCD_UART0	FT930Q UART0_DCD/UART1_RTS/GPIO28
CN1-4	RI_UART0	FT930Q UART0_RI/UART1_CTS/SPIM_SS0/GPIO29
CN1-5	SPIM_SSn0	FT930Q SPIM_SS0/GPIO30

Connector Pin	Name	Description
CN1-6	GND	0V
CN1-7	SPIM_SSn2	FT930Q SPIM_SS2/GPIO32
CN1-8	SPIM_SSn1	FT930Q SPIM_SS1/GPIO31
CN1-9	SPIM_SCK	FT930Q SPIM_CLK/SPIS_CLK/GPIO34
CN1-10	SPIM_SSn3	FT930Q SPIM_SS3/GPIO33
CN1-11	SPIM_MOSI	FT930Q SPIM_MOSI/SPIS_MOSI/GPIO36
CN1-12	SPIM_MISO	FT930Q SPIM_MISO/SPIS_MISO/GPIO35
CN1-13	SPIM_IO3	FT930Q SPIM_IO3/RTC_REF/GPIO38
CN1-14	SPIM_IO2	FT930Q SPIM_IO2/SPIS_SS/GPIO37
CN1-15	GND	0V
CN1-16	RESETn	FT930Q RESETN
CN1-17	SD_CLK	FT930Q SPIS_CLK/SD_CLK/GPIO0
CN1-18	VBUS_DTC	FT930Q VBUS_DTC/GPIO39
CN1-19	SD_DETn	FT930Q SPIS_MOSI/SD_CD/GPIO2
CN1-20	SD_CMD	FT930Q SPIS_MISO/SD_CMD/GPIO1
CN1-21	SD_DAT1	FT930Q PWM7/SD_DATA1/PWM0/GPIO4
CN1-22	SD_DAT0	FT930Q SPIS_SS/SD_DATA0/GPIO3
CN1-23	SD_DAT3	FT930Q PWM5/SD_DATA3/GPIO6
CN1-24	SD_DAT2	FT930Q PWM6/SD_DATA2/PWM1/GPIO5
CN1-25	GND	0V
CN1-26	SD_WPn	FT930Q PWM4/SD_WP/GPIO7
CN1-27	PWM2_CONF2	FT930Q PWM2/GPIO9
CN1-28	PWM3_CONF2	FT930Q PWM3/GPIO8
CN1-29	PWM0_CONF2	FT930Q PWM0/GPIO11
CN1-30	PWM1_CONF2	FT930Q PWM1/GPIO10

Table 4-2 MM930Mini Module Connection – CN1

Connector Pin	Name	Description
CN2-1	CTS_UART0	FT930Q UART0_CTS/PWM0/GPIO25
CN2-2	RTS_UART0	FT930Q UART0_RTS/PWM1/GPIO24
CN2-3	TXD_UART0	FT930Q UART0_TXD/PWM2/GPIO23
CN2-4	RXD_UART0	FT930Q UART0_RXD/PWM3/GPIO22
CN2-5	RI_UART2	FT930Q UART2_RI/UART3_CTS/GPIO21

Connector Pin	Name	Description
CN2-6	GND	0V
CN2-7	DSR_UART2	FT930Q UART2_DSR/UART3_TXD/GPIO19
CN2-8	DCD_UART2	FT930Q UART2_DCD/UART3_RTS/GPIO20
CN2-9	CTS_UART2	FT930Q UART2_CTS/GPIO17
CN2-10	DTR_UART2	FT930Q UART2_DTR/UART3_RXD/GPIO18
CN2-11	TXD_UART2	FT930Q UART2_TXD/GPIO15
CN2-12	RTS_UART2	FT930Q UART2_RTS/GPIO16
CN2-13	GND	0V
CN2-14	RXD_UART2	FT930Q UART2_RXD/GPIO14
CN2-15	I2C_SCL	FT930Q I2CM_SCL/I2CS_SCL/GPIO12
CN2-16	I2C_SDA	FT930Q I2CM_SDA/I2CS_SDA/GPIO13
CN2-17	DAC0	FT930Q DAC0 output pin
CN2-18	GND	0V
CN2-19	DAC_REFP_2	Alternative DAC voltage reference
CN2-20	DAC1	FT930Q DAC1 output pin
CN2-21	GND	0V
CN2-22	GND	0V
CN2-23	ADC_REFP_2	Alternative ADC voltage reference
CN2-24	ADC1	ADC1 input pin
CN2-25	ADC2	ADC2 input pin
CN2-26	ADC3	ADC3 input pin
CN2-27	VCCIO_3V3	VCCIO3V3
CN2-28	VCCIO_3V3	VCCIO3V3
CN2-29	VDD_5V0	5VDC input to the 3.3V IC regulator (U2)
CN2-30	VCCIO_3V3	VCCIO3V3

Table 4-3 MM930Mini Module Connection – CN2

4.1 Power Supply Configuration

The MM930Mini Module allows configuration with both USB Bus-Powered designs and USB Self-Powered designs:

USB Bus-Powered:

- 1) Connect VBUS to VDD_5V0 (JP1, connect pin 1 to pin 2). This connection takes the power from the USB bus (VBUS) and connects it to the input of the voltage regulator on the MM930Mini Module. The voltage regulator, in turn, provides power to VCCIO_3V3, VUSB_3V3, and VCC_3V3A pins on the FT930Q chip.
- 2) Connect VREG_3V3 to VCCIO_3V3 (JP2, connect pin 1 to pin 2). This connection provides 3.3V power to VCCIO_3V3 on the FT930Q chip.

USB Self-Powered:

- 1) Leave VBUS to VDD_5V0 (JP1) unconnected.
- 2) Connect an external 5.0VDC power supply to VDD_5V0 (5.0VDC to CN2, pin 29). This connection provides power from an external power supply and connects it to the input of the voltage regulator on the MM930Mini Module.
- 3) Connect VREG_3V3 to VCCIO_3V3 (JP2, connect pin 1 to pin2). This connection provides 3.3V power to VCCIO_3V3 on the FT930Q chip.

On-Board Regulator

The MM930Mini Module includes an on-board SPX3819 500mA low-noise LDO voltage regulator (U2), see Figure 4-2. This regulator provides power to internal and external circuits up to 500mA. The 10nF capacitor (C22) lowers the output noise of the regulator.

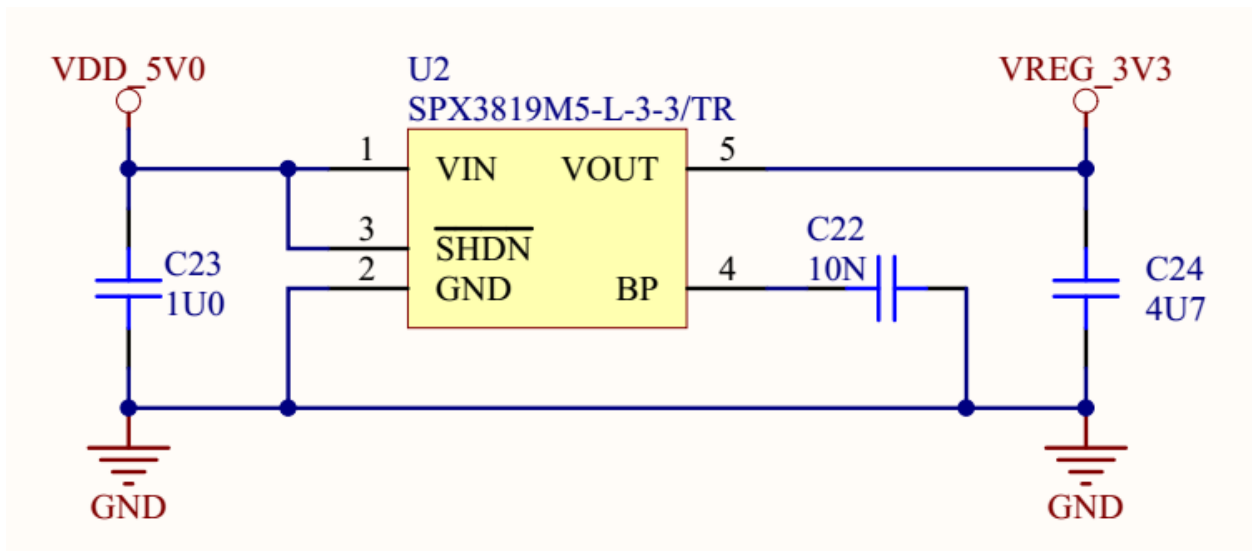

Figure 4-2 Power Supply

5 Mechanical Details

The mechanical details of the MM930Mini Module are shown in Figure 5-1:

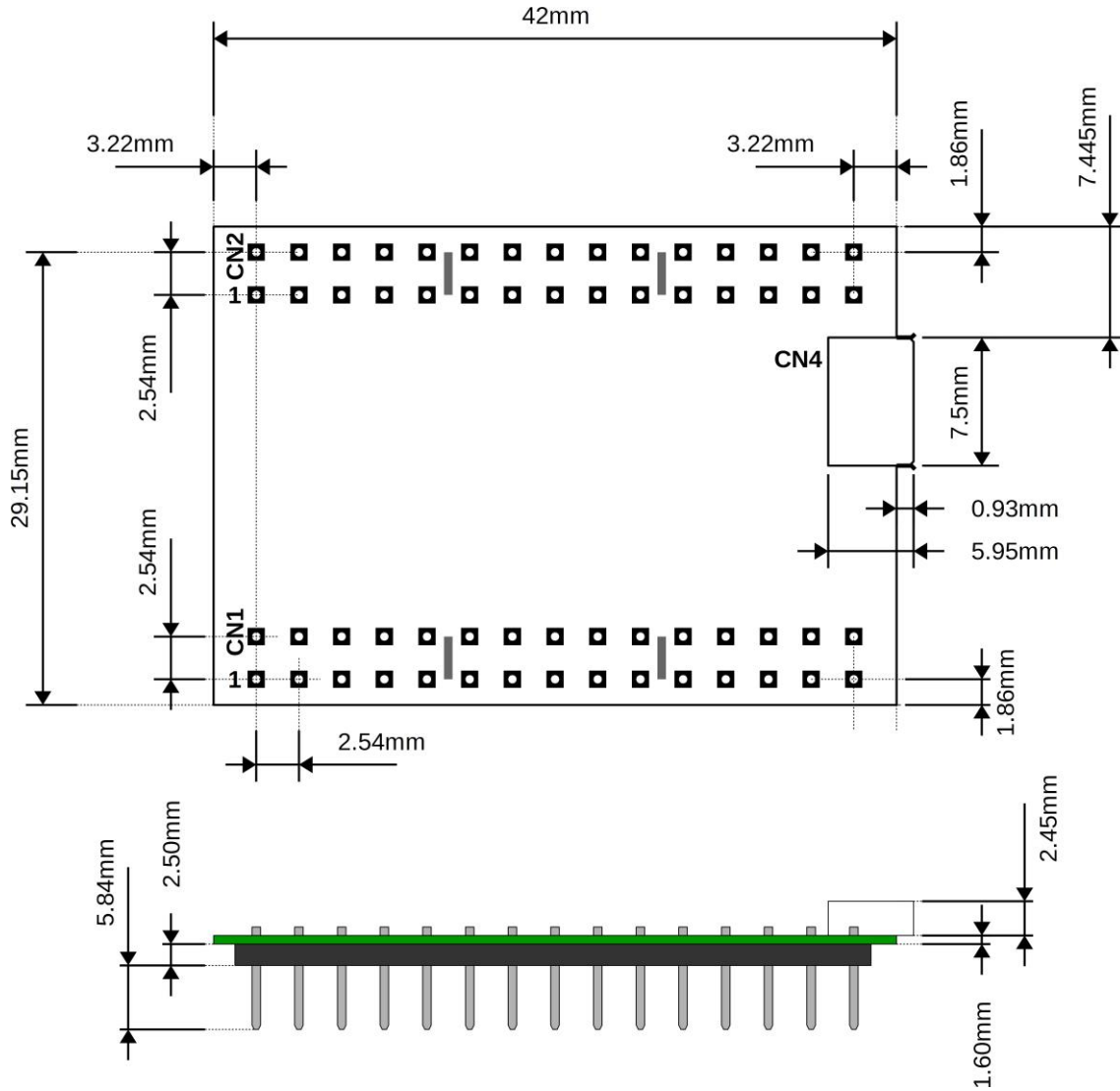

Figure 5-1 MM930Mini Module Dimensions

All dimensions are in millimetres.

The headers CN1 and CN2 are mounted to the bottom of the PCB. The overall height below the PCB is 8.38mm, with a body which exposes 5.84mm of the pins. The pins are 0.64mm (0.025-inch) square.

The micro-B USB connector has a height of 2.45mm.

6 Schematic Diagram

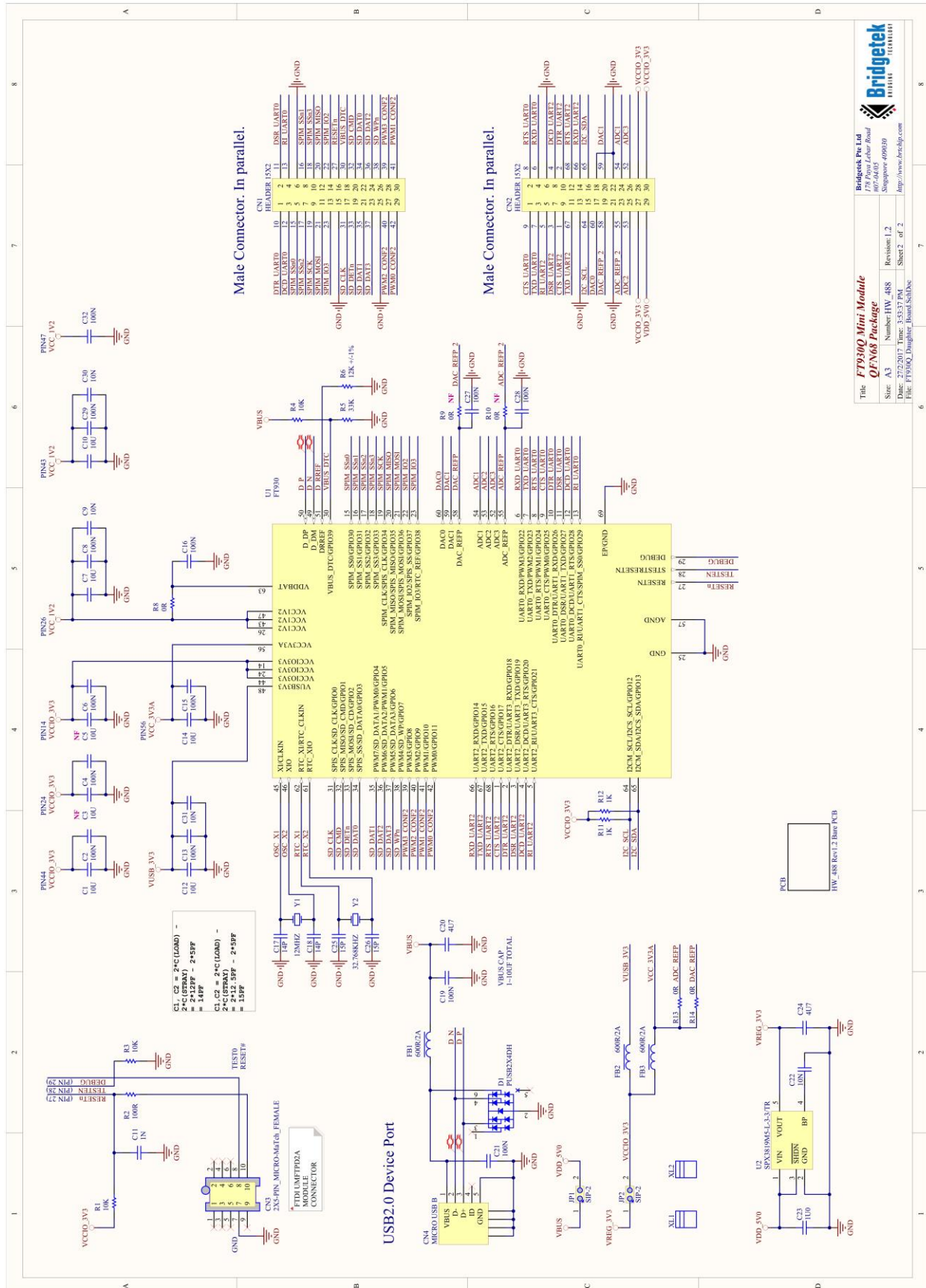

Bridgetek Pte Ltd
179 Pagar Road
07/04/05
Singapore 070929
http://www.bridgetek.com

FF9300 Mini Module
QFN68 Package

Size: A3 Number: HW_488 Revision: 1.2
Date: 27/2/2017 Time: 3:53:37 PM
File: FF9300_2_Highlight_Brand_SchDoc

Sheet 2 of 2

Figure 6-1 MM930Mini Module Schematic

7 Contact Information

Headquarters – Singapore

Bridgetek Pte Ltd
178 Paya Lebar Road, #07-03
Singapore 409030
Tel: +65 6547 4827
Fax: +65 6841 6071

E-mail (Sales) sales.apac@brtchip.com
E-mail (Support) support.apac@brtchip.com

Branch Office – Taipei, Taiwan

Bridgetek Pte Ltd, Taiwan Branch
2 Floor, No. 516, Sec. 1, Nei Hu Road, Nei Hu
District
Taipei 114
Taiwan, R.O.C.
Tel: +886 (2) 8797 5691
Fax: +886 (2) 8751 9737

E-mail (Sales) sales.apac@brtchip.com
E-mail (Support) support.apac@brtchip.com

Branch Office - Glasgow, United Kingdom

Bridgetek Pte. Ltd.
Unit 1, 2 Seaward Place, Centurion Business Park
Glasgow G41 1HH
United Kingdom
Tel: +44 (0) 141 429 2777
Fax: +44 (0) 141 429 2758

E-mail (Sales) sales.emea@brtchip.com
E-mail (Support) support.emea@brtchip.com

Branch Office – Vietnam

Bridgetek VietNam Company Limited
Lutaco Tower Building, 5th Floor, 173A Nguyen
Van Troi,
Ward 11, Phu Nhuan District,
Ho Chi Minh City, Vietnam
Tel : 08 38453222
Fax : 08 38455222

E-mail (Sales) sales.apac@brtchip.com
E-mail (Support) support.apac@brtchip.com

Web Site

<http://brtchip.com/>

Distributor and Sales Representatives

Please visit the Sales Network page of the [Bridgetek website](#) for the contact details of our distributor(s) and sales representative(s) in your country.

System and equipment manufacturers and designers are responsible to ensure that their systems, and any Bridgetek Pte Ltd (BRT Chip) devices incorporated in their systems, meet all applicable safety, regulatory and system-level performance requirements. All application-related information in this document (including application descriptions, suggested Bridgetek devices and other materials) is provided for reference only. While Bridgetek has taken care to assure it is accurate, this information is subject to customer confirmation, and Bridgetek disclaims all liability for system designs and for any applications assistance provided by Bridgetek. Use of Bridgetek devices in life support and/or safety applications is entirely at the user's risk, and the user agrees to defend, indemnify and hold harmless Bridgetek from any and all damages, claims, suits or expense resulting from such use. This document is subject to change without notice. No freedom to use patents or other intellectual property rights is implied by the publication of this document. Neither the whole nor any part of the information contained in, or the product described in this document, may be adapted or reproduced in any material or electronic form without the prior written consent of the copyright holder. Bridgetek Pte Ltd, 178 Paya Lebar Road, #07-03, Singapore 409030. Singapore Registered Company Number: 201542387H.

Appendix A – References

Document References

- [DS_FT930_1_2_3](#)
- [FT90x toolchain](#)
- [Firmware examples](#)

Acronyms and Abbreviations

Terms	Description
API	Application Programming Interface
I ² C	Inter-Integrated Circuit
MCU	Micro Controller Unit
QSPI	Quad Serial Peripheral interface
SPI	Serial Peripheral Interface
USB	Universal Serial Bus
USB-IF	USB Implementers Forum

Appendix B – List of Tables & Figures

List of Tables

Table 4-1 MM930Mini Module Connectors.....	6
Table 4-2 MM930Mini Module Connection – CN1	7
Table 4-3 MM930Mini Module Connection – CN2	8

List of Figures

Figure 2-1 Using the MM930Mini Module VCOM.....	2
Figure 2-2 Using the MM930Mini Module as BOMS/HID/CDC.....	3
Figure 4-1 MM930Mini Module Electrical Connections (Top View)	6
Figure 4-2 Power Supply	9
Figure 5-1 MM930Mini Module Dimensions	10
Figure 6-1 MM930Mini Module Schematic.....	11

Appendix C – Revision History

Document Title: MM930Mini Module Datasheet
Document Reference No.: BRT_000067
Clearance No.: BRT#065
Product Page: <http://brtchip.com/product>
Document Feedback: [Send Feedback](#)

Revision	Changes	Date
1.0	Initial Release	2017-03-02