



### FEATURES

- High efficiency: 95% @ 28V/16A
- Size:
  - 61.0x57.9x10.8mm (2.40"x2.28"x0.43") w/o heat-spreader
  - 61.0x57.9x12.5mm (2.40"x2.28"x0.49") with heat-spreader
- Industry standard footprint and pinout
- Fixed frequency operation
- Input UVLO
- OTP and output OVP
- Output OCP hiccup mode
- Output voltage trim range:
  - 23~33V and 14~33V optional
- Monotonic startup into normal and pre-biased loads
- 1500V isolation and basic insulation
- No minimum load required
- No negative current during power or enable on/off
- ISO 9001, TL 9000, ISO 14001, QS 9000, OHSAS18001 certified manufacturing facility
- UL/cUL 60950-1 (US & Canada)

### H48SC28016

Half Brick DC/DC Power Modules  
36~75V in, 28V/16A out, 450W

H48SC28016, 36~75V input, isolated single output, Half Brick, are full digital control DC/DC converters, it provides up to 450 watts of power in an industry standard, DOSA compliant footprint and pin out; the typical efficiency is 95% at 48V input, 28V output and 16A load. There is a built-in digital PWM controller in the H48SC28016, which is used to complete the Vo feedback, PWM signal generation, fault protection, and PMBUS communications, and so on. With the digital control, many design and application flexibility, advanced performance, and reliability are obtained.

### OPTIONS

- Negative or Positive Remote On/Off
- Open frame/Heat spreader
- Digital pins, PMBus

### APPLICATIONS

- Optical Transport
- Data Networking
- Communications
- Servers

## TECHNICAL SPECIFICATIONS

( $T_A=25^{\circ}\text{C}$ , airflow rate=300 LFM,  $V_{in}=48\text{Vdc}$ , nominal  $V_{out}$  unless otherwise noted.)

PARAMETER	NOTES and CONDITIONS	H48SC28016			
		Min.	Typ.	Max.	Units
<b>ABSOLUTE MAXIMUM RATINGS</b>					
Input Voltage					Vdc
Continuous		0		80	Vdc
Transient (100ms)	100ms			100	Vdc
Operating Ambient Temperature		-40		85	$^{\circ}\text{C}$
Storage Temperature		-55		125	$^{\circ}\text{C}$
Input/output Isolation Voltage				1500	Vdc
<b>INPUT CHARACTERISTICS</b>					
Operating Input Voltage		36	48	75	Vdc
Input Under-Voltage Lockout					
Turn-On Voltage Threshold		33.0	35.0	36.0	Vdc
Turn-Off Voltage Threshold		30.0	33.0	35.0	Vdc
Lockout Hysteresis Voltage			2		Vdc
Maximum Input Current	Full Load, 36Vin			17	A
No-Load Input Current	Vin=48V, Io=0A		110		mA
Off Converter Input Current	Vin=48V, Io=0A		22		mA
Inrush Current ( I <sup>2</sup> t )				1	A <sup>2</sup> s
Input Reflected-Ripple Current	P-P thru 12 $\mu\text{H}$ inductor, 5Hz to 20MHz		80		mA
Input Voltage Ripple Rejection	120 Hz		50		dB
<b>OUTPUT CHARACTERISTICS</b>					
Output Voltage Set Point	Vin=48V, Io=Io.max, Tc=25 $^{\circ}\text{C}$	27.72	28	28.28	Vdc
Output Regulation					
Over Load	Io=Io, min to Io, max			$\pm 56$	mV
Over Line	Vin=36V to 75V		$\pm 56$		mV
Over Temperature	Tc=-40 $^{\circ}\text{C}$ to 85 $^{\circ}\text{C}$			$\pm 560$	mV
Total Output Voltage Range	Over sample load, line and temperature	27.16		28.84	V
Output Voltage Ripple and Noise	5Hz to 20MHz bandwidth				
Peak-to-Peak	Vin=48V, Full Load, 50 $\mu\text{F}$ ceramic, 1000 $\mu\text{F}$ Electrolytic Capacitor		100		mV
RMS	Vin=48V, Full Load, 50 $\mu\text{F}$ ceramic, 1000 $\mu\text{F}$ Electrolytic Capacitor		30		mV
Operating Output Current Range	Vin=36V to 75V	0		16	A
Output Over Current Protection (hiccup mode)	Output Voltage 10% Low	17.6		24	A
<b>DYNAMIC CHARACTERISTICS</b>					
Output Voltage Current Transient	48Vin, 50 $\mu\text{F}$ ceramic, 1000 $\mu\text{F}$ Electrolytic Capacitor, 0.1A/ $\mu\text{s}$				
Positive Step Change in Output Current	75% Io.max to 50% Io.max		300		mV
Negative Step Change in Output Current	50% Io.max to 75% Io.max		300		mV
Settling Time (within 1% Vout nominal)			200		$\mu\text{s}$
Turn-On Transient					
Start-Up Time, From On/Off Control			80		mS
Start-Up Time, From Input			100		mS
Output Capacitance (note1)	Full load; 5% overshoot of Vout at startup, low ESR cap.	470		5000	$\mu\text{F}$
<b>EFFICIENCY</b>					
100% Load	Vin=36V		94.5		%
100% Load	Vin=48V		95		%
60% Load	Vin=48V		95.5		%
<b>ISOLATION CHARACTERISTICS</b>					
Input to Output				1500	Vdc
Isolation Resistance		10			M $\Omega$
Isolation Capacitance			6.9		nF
<b>FEATURE CHARACTERISTICS</b>					
Switching Frequency			120		KHz
ON/OFF Control, Negative Remote On/Off logic					
Logic Low (Module On)	Von/off			0.8	V
Logic High (Module Off)	Von/off	3.5		10	V
ON/OFF Control, Positive Remote On/Off logic					
Logic Low (Module Off)	Von/off			0.8	V
Logic High (Module On)	Von/off	3.5		10	V
ON/OFF Current (for both remote on/off logic)	Ion/off at Von/off=0.0V				mA
Leakage Current (for both remote on/off logic)	Logic High, Von/off=5V				
Output Voltage Trim Range (note2)	Pout $\leq$ max rated power, Io $\leq$ Io.max, for suffix xxxB and xxxC	-50		+18	%
	Pout $\leq$ max rated power, Io $\leq$ Io.max, for suffix xxxA and xxxH	-18		+18	%
Output Voltage Remote Sense Range	Pout $\leq$ max rated power, Io $\leq$ Io.max	-1		+10	%
Output Over-Voltage Protection	% of nominal Vout	125		150	%
<b>GENERAL SPECIFICATIONS</b>					
MTBF	Io=80% of Io, max; Ta=25 $^{\circ}\text{C}$ , airflow rate=300LFM		2.9		Mhours
Weight	Without heat spreader		62.0		grams
Weight	With heat spreader		93.5		grams
Over-Temperature Shutdown (With heat spreader)	Refer to Figure 18 for Hot spot location (48Vin, 80% Io)		110		$^{\circ}\text{C}$
Over-Temperature Shutdown ( NTC resistor )			125		$^{\circ}\text{C}$

Note: Please attach thermocouple on NTC resistor to test OTP function, the hot spots' temperature is just for reference.

Note1: If the ambient temp is less than 0 $^{\circ}\text{C}$ , double minimum output capacitance and additional 50 $\mu\text{F}$  ceramic capacitance is necessary.

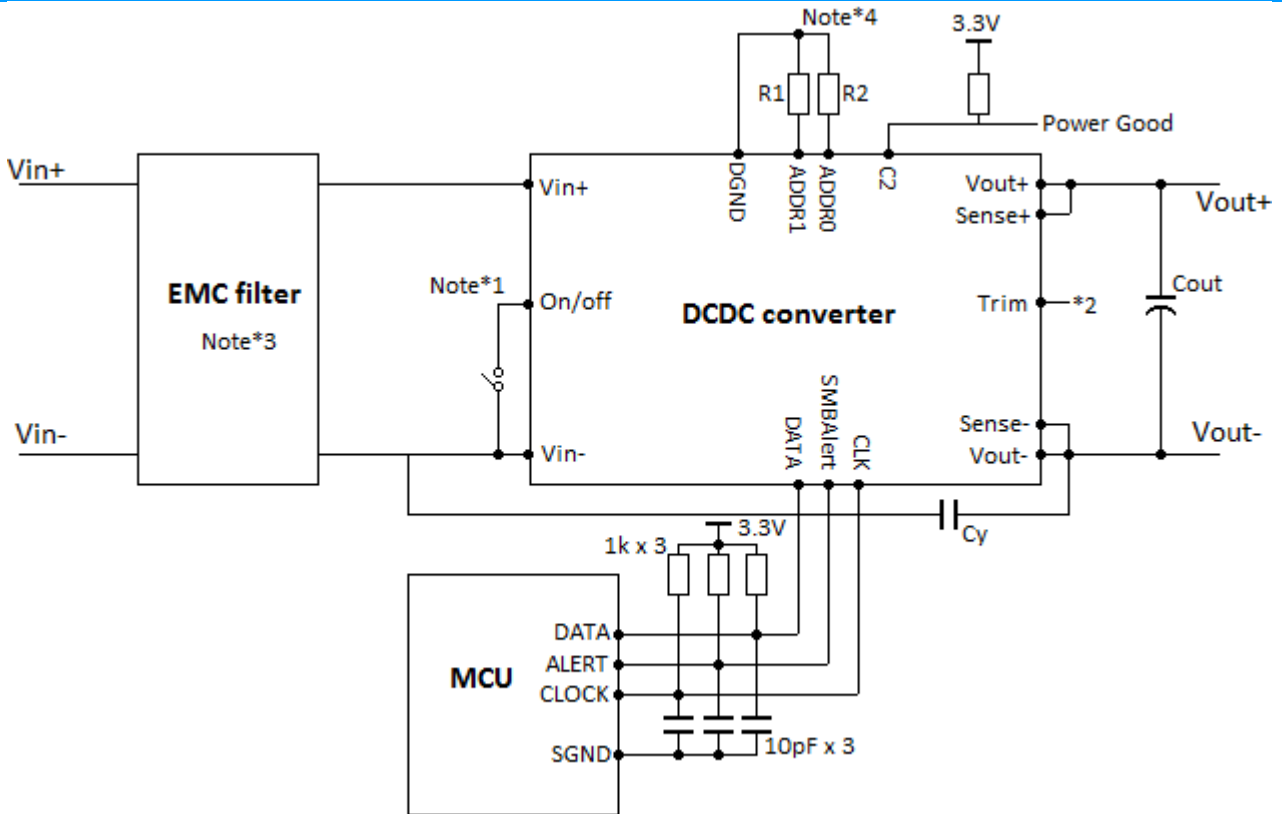
Note2: For wider output voltage trim range and larger output capacitance, please contact Delta.

## DIGITAL INTERFACE SPECIFICATIONS

( $T_A=25^{\circ}\text{C}$ , airflow rate=400 LFM,  $V_{in}=48\text{Vdc}$ , nominal  $V_{out}$  unless otherwise noted.)

PARAMETER	NOTES and CONDITIONS	H48SC28016			
		Min.	Typ.	Max.	Units
<b>PMBUS SIGNAL INTERFACE CHARACTERISTICS</b>					
Logic input high ( $V_{IH}$ )	CLK,DATA,SMBALERT,C2	2.4		3.6	Vdc
Logic input low ( $V_{IL}$ )	CLK,DATA,SMBALERT,C2			0.8	Vdc
Logic output high ( $V_{OH}$ )	CLK,DATA,SMBALERT,C2	2.5		3.6	Vdc
Logic output low ( $V_{OL}$ )	CLK,DATA,SMBALERT,C2			0.4	Vdc
Input high level current (CLK, DATA, SMALERT)	Pin voltage=3.3V	-10		10	$\mu\text{A}$
Input low level current (CLK, DATA, SMALERT)	Pin voltage=0V	-10		10	$\mu\text{A}$
Sinking current (CLK,DATA,SMBALERT,C2)				4	mA
PMBus Operating frequency range		100		400	kHz
<b>Measurement System Characteristics</b>					
Output current reading accuracy	$5\text{A}<I_{OUT}<16\text{A}$	-5	1.4	3	%
	$1\text{A}<I_{OUT}<5\text{A}$	-1.7		2.5	A
VOUT reading accuracy			1		%
VIN reading accuracy		-2		+2	Vdc
Temperature sense range		0			$^{\circ}\text{C}$
Temperature reading accuracy		-5		+5	$^{\circ}\text{C}$

## Typical Application circuit

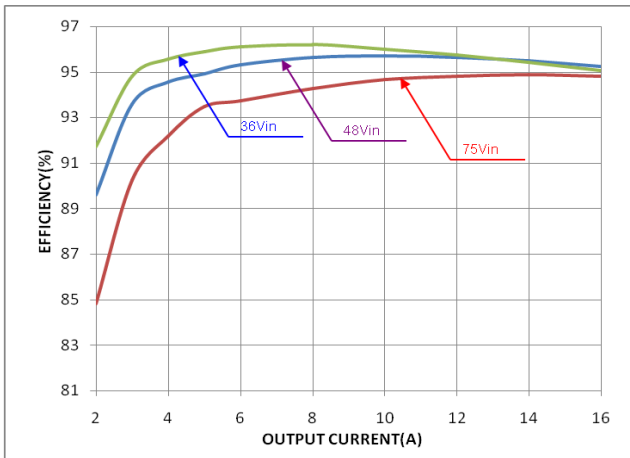


Note1 & 2: Please refer to page9 for on/off and trim implementation.

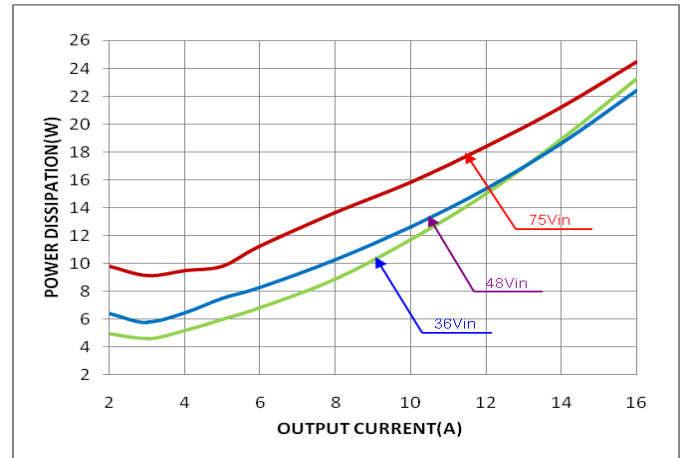
Note3: Please refer to page8 for EMC filter implementation.

Note4: Please refer to page10 for ADDR pin implementation (For with PMBus interface version).

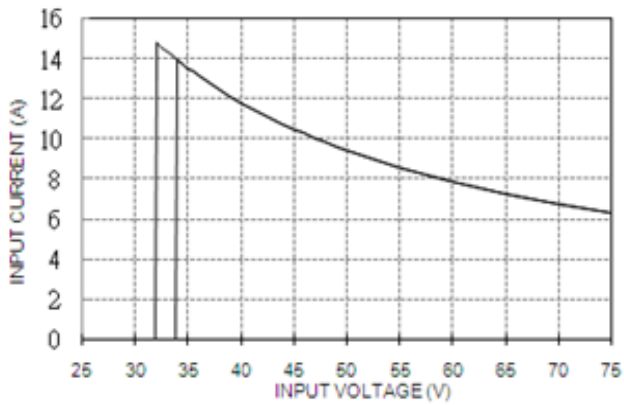
## ELECTRICAL CHARACTERISTICS CURVES



**Figure 1:** Efficiency vs. load current for 36V, 48V, and 75V input voltage at 25°C.



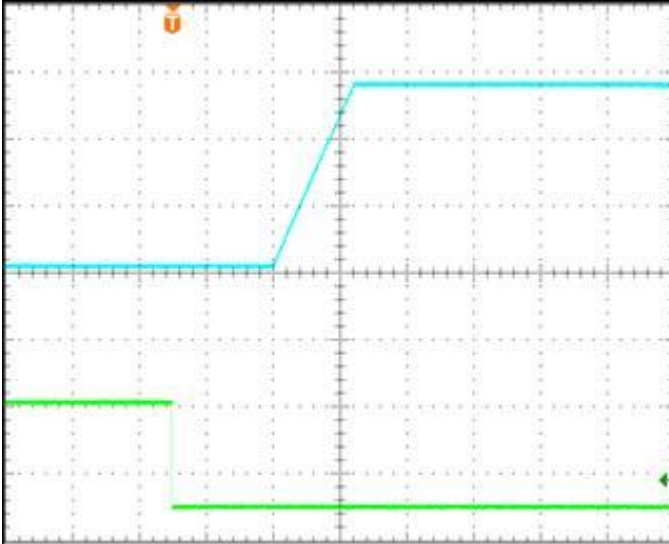
**Figure 2:** Power dissipation vs. load current for 36V, 48V, and 75V input voltage at 25°C.



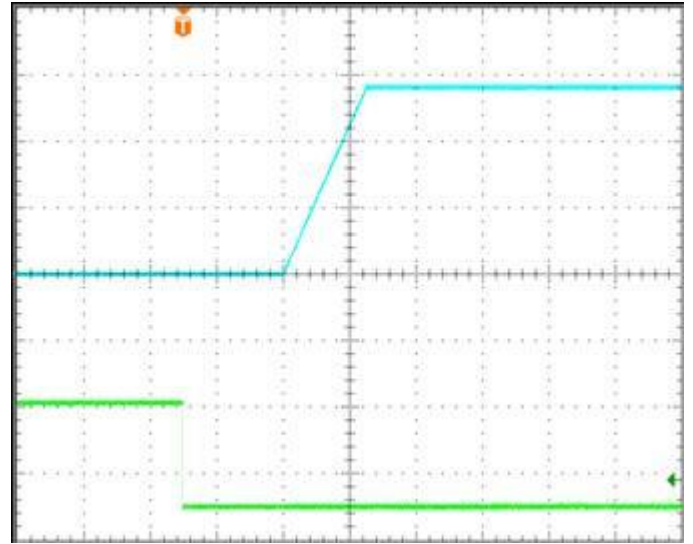
**Figure 3:** Full load input characteristics at room temperature.

## ELECTRICAL CHARACTERISTICS CURVES

### For Negative Remote On/Off Logic

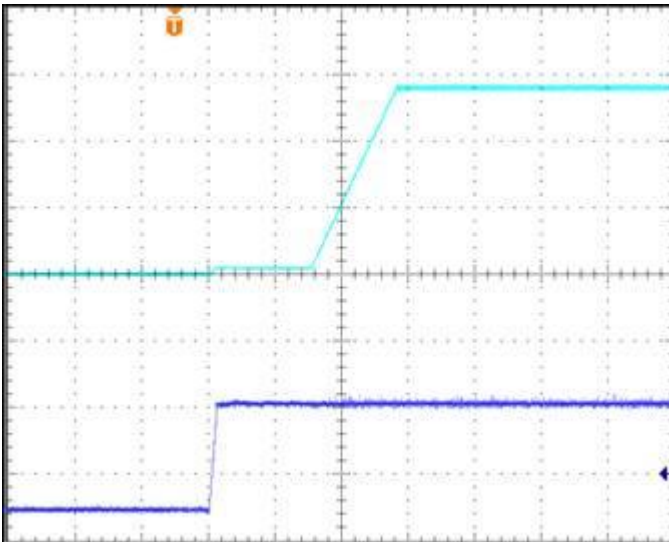


**Figure 4:** Turn-on transient at zero load current (40ms/div).  
 $V_{in}=48V$ . Top Trace:  $V_{out}$ ; 10V/div; Bottom Trace: ON/OFF input: 5V/div.

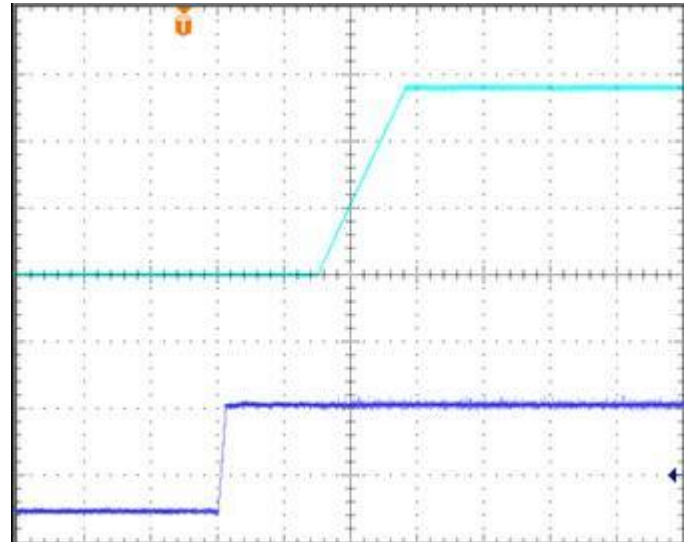


**Figure 5:** Turn-on transient at full load current (40ms/div).  
 $V_{in}=48V$ . Top Trace:  $V_{out}$ ; 10V/div; Bottom Trace: ON/OFF input: 5V/div.

### For Input Voltage Start up

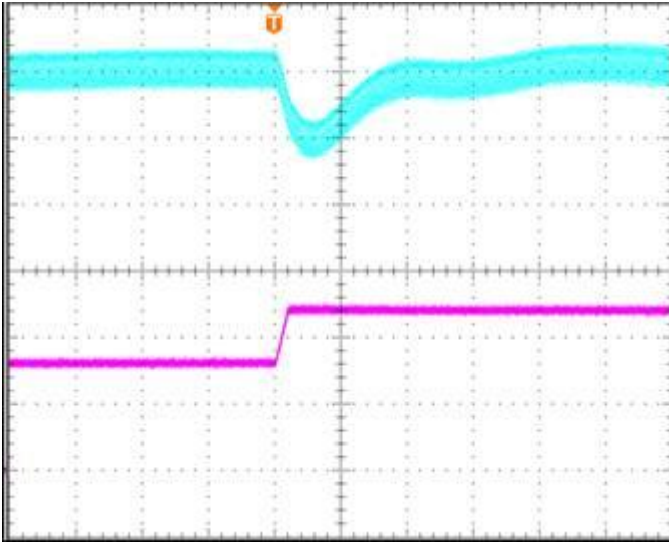


**Figure 6:** Turn-on transient at zero load current (40 ms/div).  
 Top Trace:  $V_{out}$ ; 10V/div; Bottom Trace: input voltage: 30V/div

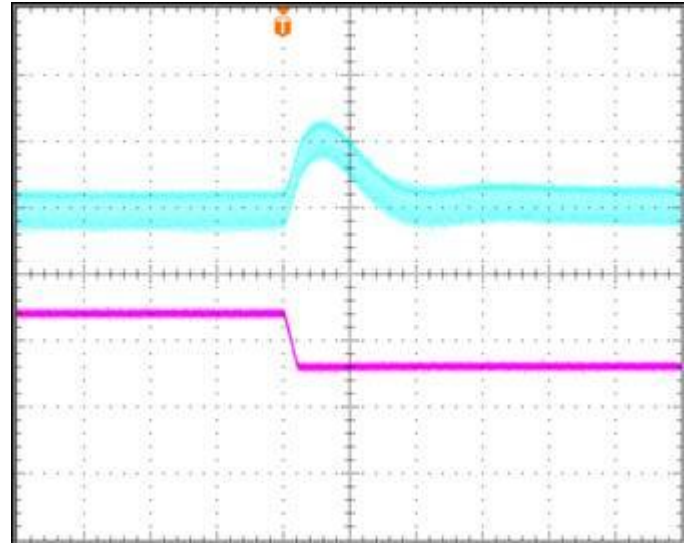


**Figure 7:** Turn-on transient at full load current (40 ms/div).  
 Top Trace:  $V_{out}$ ; 10V/div; Bottom Trace: input voltage: 30V/div

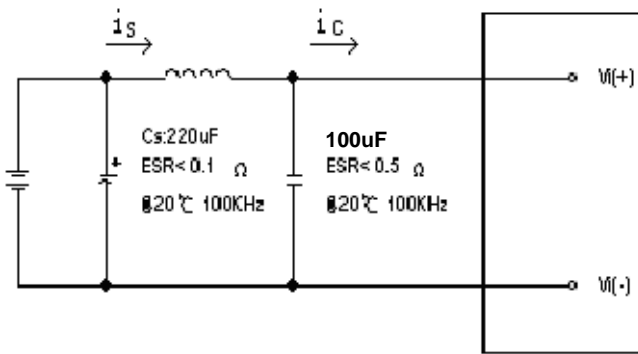
## ELECTRICAL CHARACTERISTICS CURVES



**Figure 8:** Output voltage response to step-change in load current (50%-75% of  $I_o$ , max;  $di/dt = 0.1A/\mu s$ ;  $V_{in}=48V$ ). Load cap: 1000 $\mu F$  Electrolytic Capacitor and 50 $\mu F$  ceramic capacitor. Top Trace:  $V_{out}$  (0.2V/div, 200us/div), Bottom Trace:  $I_{out}$  (5A/div). Scope measurement should be made using a BNC cable (length shorter than 20 inches). Position the load between 51 mm to 76 mm (2 inches to 3 inches) from the module

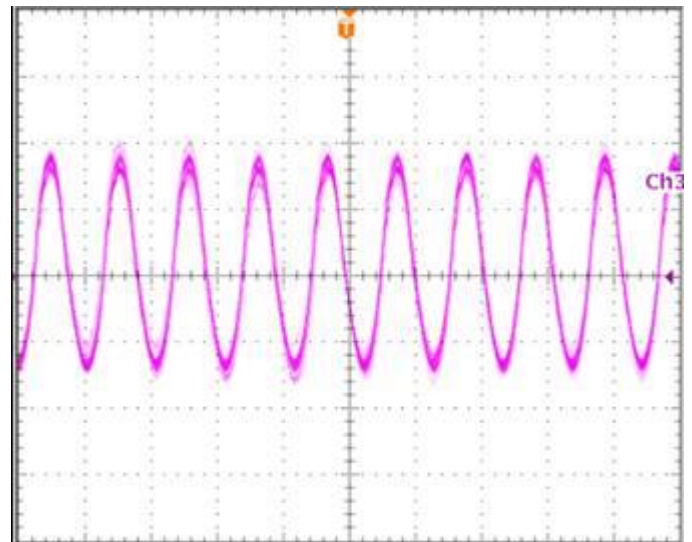


**Figure 9:** Output voltage response to step-change in load current (75%-50% of  $I_o$ , max;  $di/dt = 0.1A/\mu s$ ;  $V_{in}=48V$ ). Load cap: 1000 $\mu F$  Electrolytic Capacitor and 50 $\mu F$  ceramic capacitor. Top Trace:  $V_{out}$  (0.2V/div, 200us/div), Bottom Trace:  $I_{out}$  (5A/div). Scope measurement should be made using a BNC cable (length shorter than 20 inches). Position the load between 51 mm to 76 mm (2 inches to 3 inches) from the module



**Figure 10:** Test set-up diagram showing measurement points for Input Terminal Ripple Current and Input Reflected Ripple Current.

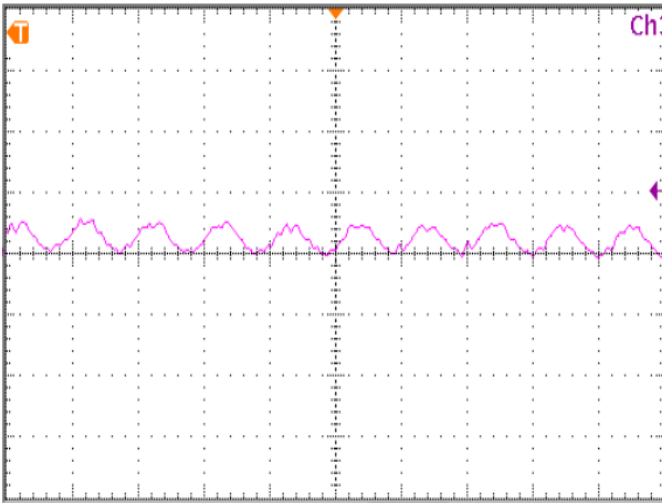
Note: Measured input reflected-ripple current with a simulated source Inductance ( $L_{TEST}$ ) of 12  $\mu H$ . Capacitor  $C_s$  offset possible battery impedance. Measure current as shown above.



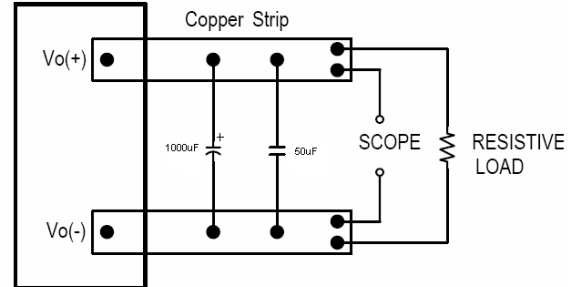
**Figure 11:** Input Terminal Ripple Current,  $i_c$ , at max output current and nominal input voltage with 12 $\mu H$  source impedance and 100 $\mu F$  electrolytic capacitor (500 mA/div, 4us/div).



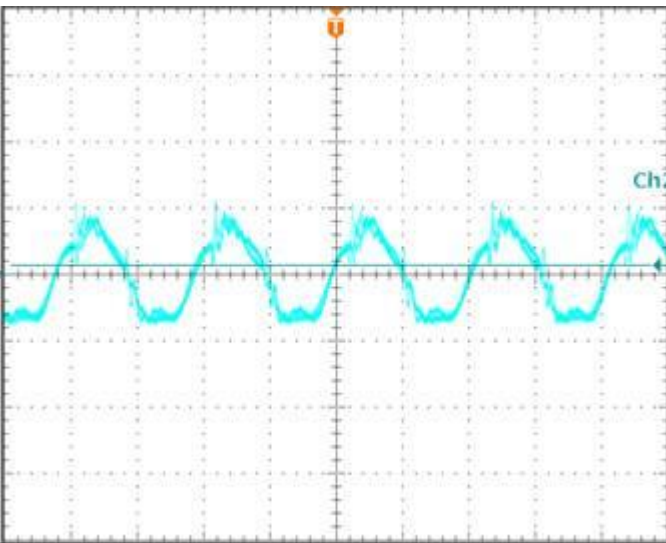
## ELECTRICAL CHARACTERISTICS CURVES



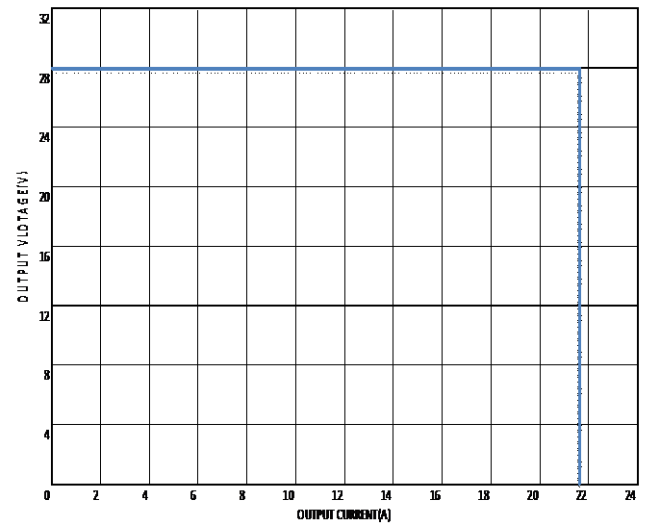
**Figure 12:** Input reflected ripple current,  $i_s$ , through a  $12\mu\text{H}$  source inductor at nominal input voltage and max load current (25mA/div, 4µs/div).



**Figure 13:** Output voltage noise and ripple measurement test setup.



**Figure 14:** Output voltage ripple at nominal input voltage and max load current (50 mV/div, 2µs/div)  
Load capacitance:  $50\mu\text{F}$  ceramic capacitor and  $1000\mu\text{F}$  Electrolytic Capacitor. Bandwidth: 20 MHz.



**Figure 15:** Output voltage vs. load current showing typical current limit curves and converter shutdown points.

## DESIGN CONSIDERATIONS

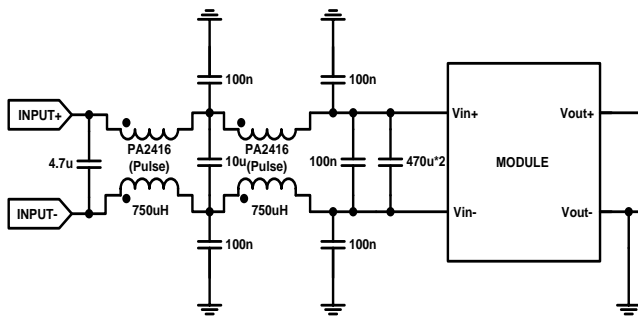
### Input Source Impedance

The impedance of the input source connecting to the DC/DC power modules will interact with the modules and affect the stability. A low ac-impedance input source is recommended. If the source inductance is more than a few  $\mu\text{H}$ , we advise 220 $\mu\text{F}$  electrolytic capacitor (ESR < 0.7  $\Omega$  at 100 kHz) mounted close to the input of the module to improve the stability.

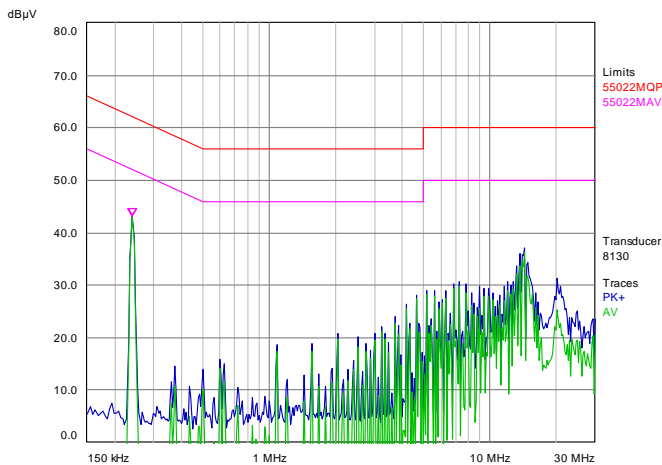
### Layout and EMC Considerations

Delta's DC/DC power modules are designed to operate in a wide variety of systems and applications. For design assistance with EMC compliance and related PWB layout issues, please contact Delta's technical support team. Below is the reference design for an input filter tested with H48SC28016 to meet class B in CISPR 22.

### Schematic and Components List



**Test Result:**  $V_{in}=48\text{V}$ ,  $I_o=16\text{A}$



Blue Line is quasi peak mode; green line is average mode.

### Safety Considerations

The power module must be installed in compliance with the spacing and separation requirements of the end-user's safety agency standard, i.e., UL60950-1, CSA C22.2 NO. 60950-1 2nd and IEC 60950-1 2nd: 2005 and EN 60950-1 2nd: 2006+A11+A1: 2010, if the system in which the power module is to be used must meet safety agency requirements.

Basic insulation based on 75 Vdc input is provided between the input and output of the module for the purpose of applying insulation requirements when the input to this DC-to-DC converter is identified as TNV-2 or SELV. An additional evaluation is needed if the source is other than TNV-2 or SELV.

When the input source is SELV circuit, the power module meets SELV (safety extra-low voltage) requirements. If the input source is a hazardous voltage which is greater than 60 Vdc and less than or equal to 75 Vdc, for the module's output to meet SELV requirements, all of the following must be met:

- The input source must be insulated from the ac mains by reinforced or double insulation.
- The input terminals of the module are not operator accessible.
- A SELV reliability test is conducted on the system where the module is used, in combination with the module, to ensure that under a single fault, hazardous voltage does not appear at the module's output.

When installed into a Class II equipment (without grounding), spacing consideration should be given to the end-use installation, as the spacing between the module and mounting surface have not been evaluated.

The power module has extra-low voltage (ELV) outputs when all inputs are ELV.

This power module is not internally fused. To achieve optimum safety and system protection, an input line fuse is highly recommended. The safety agencies require a fast-blow fuse with 30A maximum rating to be installed in the ungrounded lead. A lower rated fuse can be used based on the maximum inrush transient energy and maximum input current.

### Soldering and Cleaning Considerations

Post solder cleaning is usually the final board assembly process before the board or system undergoes electrical testing. Inadequate cleaning and/or drying may lower the reliability of a power module and severely affect the



reliability of a power module and severely affect the finished circuit board assembly test. Adequate cleaning and/or drying is especially important for un-encapsulated and/or open frame type power modules. For assistance on appropriate soldering and cleaning procedures, please contact Delta's technical support team.

## FEATURES DESCRIPTIONS

### Over-Current Protection

The modules include an internal output over-current protection circuit, which will endure current limiting for an unlimited duration during output overload. If the output current exceeds the OCP set point, the modules will shut down (hiccup mode).

The modules will try to restart after shutdown. If the overload condition still exists, the module will shut down again. This restart trial will continue until the overload condition is corrected.

### Over-Voltage Protection

The modules include an internal output over-voltage protection circuit, which monitors the voltage on the output terminals. If this voltage exceeds the over-voltage set point, the protection circuit will constrain the max duty cycle to limit the output voltage, if the output voltage continuously increases the modules will shut down, and then restart after a hiccup-time (hiccup mode).

### Over-Temperature Protection

The over-temperature protection consists of circuitry that provides protection from thermal damage. If the temperature exceeds the over-temperature threshold the module will shut down. The module will restart after the temperature is within specification.

### Remote On/Off

The remote on/off feature on the module can be either negative or positive logic. Negative logic turns the module on during a logic low and off during a logic high. Positive logic turns the modules on during a logic high and off during a logic low.

Remote on/off can be controlled by an external switch between the on/off terminal and the Vi (-) terminal. The switch can be an open collector or open drain. For negative logic if the remote on/off feature is not used, please short the on/off pin to Vi (-). For positive logic if the remote on/off feature is not used, please leave the

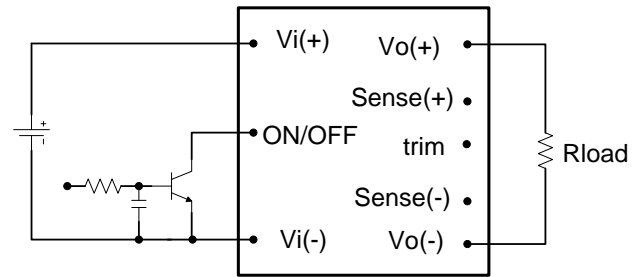


Figure 16: Remote on/off implementation

### Output Voltage Adjustment (TRIM)

To increase or decrease the output voltage set point, connect an external resistor between the TRIM pin and the Sense+ or Sense- pin. The TRIM pin should be left open if this feature is not used.

For trim down, the external resistor value required to obtain a percentage of output voltage change  $\Delta\%$  is defined as:

$$R_{trim-down} = \left[ \frac{100}{\Delta} - 2 \right] (K\Omega)$$

Ex. When Trim-down -10% ( $28V \times 0.9 = 25.2V$ )

$$R_{trim-down} = \left[ \frac{100}{10} - 2 \right] (K\Omega) = 8(K\Omega)$$

For trim up, the external resistor value required to obtain a percentage output voltage change  $\Delta\%$  is defined as:

$$R_{trim-up} = \frac{V_o (100 + \Delta)}{1.225\Delta} - \frac{100}{\Delta} - 2 (K\Omega)$$

Ex. When Trim-up +10% ( $28V \times 1.1 = 30.8V$ )

$$R_{trim-up} = \frac{28 \times (100 + 10)}{1.225 \times 10} - \frac{100}{10} - 2 = 239.4 (K\Omega)$$

The output voltage can also be trimmed by potential applied at the Trim pin.

$$V_o = (V_{trim} + 1.225) \times 11.43$$

Where trim  $V_{trim}$  is the potential applied at the Trim pin, and  $V_o$  is the desired output voltage.

The output voltage can be increased by both the remote sense and the trim, however the maximum increase is the larger of either the remote sense or the trim, not the sum of both.

When using remote sense and trim, the output voltage of the module is usually increased, which increases the power output of the module with the same output current.

Care should be taken to ensure that the maximum output power of the module remains at or below the maximum rated power.

### Configurable Control Pins

The module contains one configurable control pins C2, referenced to the module secondary SIG\_GND. See Mechanical Views for pin locations. The following table list the default factory configurations for the functions assigned to the pin.

C2 Pin Designation/Function	Configuration
Power Good	Factory Default
On/Off	Optional Vias PMBUS

Note1: Power Good is an Open-Drain output.

Note2: On/Off is an Open-Drain input

### DIGITAL FEATURE DESCRIPTIONS

The module has a digital PMBus interface to allow the module to be monitored, controlled and configured by the system. The module supports 4 PMBus signal lines, Data, Clock, SMBALERT (optional), Control (C2 pin, optional), and 2 Address line Addr0 and Addr1. More detail PMBus information can be found in the PMBus Power Management Protocol Specification, Part I and part II, revision 1.2; which is shown in <http://pmbus.org>. Both 100kHz and 400kHz bus speeds are supported by the module. Connection for the PMBus interface should be following the High Power DC specifications given in section 3.1.3 in the SMBus specification V2.0 or the Low Power DC specifications in section 3.1.2. The complete SMBus specification is shown in <http://smbus.org>.

The module supports the Packet Error Checking (PEC) protocol. It can check the PEC byte provided by the PMBus master, and include a PEC byte in all message responses to the master.

SMBALERT protocol is also supported by the module. SMBALERT line is also a wired-AND signal; by which the module can alert the PMBUS master via pulling the SMBALERT pin to an active low. There is only one way that the master and the module response to the alert of SMBALERT line.

This way is for the module used in a system that does not support Alert Response Address (ARA). The module is to retain its resistor programmed address, when it is in an ALERT active condition. The master will

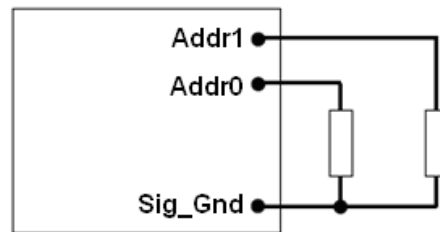
communicate with the slave module using the programmed address, and using the various READ\_STATUS commands to find who cause for the SMBALERT. The CLEAR\_FAULTS command will clear the SMBALERT.

The module contains a data flash used to store configuration settings, which will not be programmed into the device data flash automatically. The STORE\_DEFAULT\_ALL command must be used to commit the current settings are transfer from RAM to data flash as device defaults.

### PMBUS Addressing

The Module has flexible PMBUS addressing capability. When connect different resistor from Addr0 and Addr1 pin to DGND pin, 64 possible addresses can be acquired. The address is in the form of octal digits; Each pin offers one octal digit, and then combine together to form the decimal address as shown in below.

$$\text{Address} = 8 * \text{ADDR1} + \text{ADDR0}$$



Corresponded to each octal digit, the requested resistor values are shown in below, and +/-1% resistors accuracy can be accepted. If there is any resistances exceeding the requested range, address 126 will be return. 0-12 and 40, 44, 45, and 55 in decimal address can't be used, since they are reserved according to the SMBus specifications, and which will also return address 126.

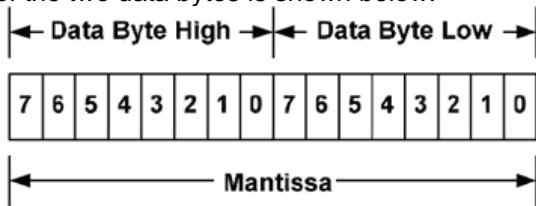
Octal digit	Resistor(Kohm)
0	10
1	15.4
2	23.7
3	36.5
4	54.9
5	84.5
6	130
7	200

Address 127 (or 0x7F) is reserved address by PMBus. The built-in digital PWM controller uses this address for Factory test purposes, and will ack this address. Application should not use this address either.

## PMBus Data Format

The module receives and report data in LINEAR format. The Exponent of the data words is fixed at a reasonable value for the command; altering the exponent is not supported. DIRECT format is not supported by the module.

For commands that set or report any voltage thresholds related to the output voltage, the module supports the linear data format consisting of a two-byte value with a 16-bit, unsigned mantissa, and a fixed exponent of -9. The format of the two data bytes is shown below:



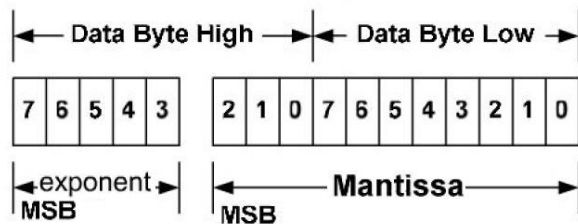
The equation can be written as:

$$V_{out} = \text{Mantissa} \times 2^{(-9)}$$

For example, considering set  $V_{out}$  to 28V by VOUT\_COMMAND, the read/write data can be calculated refer to below process:

$$\text{Mantissa} = V_{out} / 2^{(-9)} = 28 / 2^{(-9)} = 14336;$$

Converter the calculated Mantissa to hexadecimal 0x3800. For commands that set or report all other thresholds, including input voltages, output current, temperature, time and frequency, the supported linear data format is a two-byte value with: an 11 bit, two's complement mantissa, and a 5 bit, two's complement exponent (scaling factor). The format of the two data bytes is shown as in below.



The equation can be written as:

$$\text{Value} = \text{Mantissa} \times 2^{(\text{exponent})}$$

For example, considering set the turn on threshold of input under voltage lockout to 34V by VIN\_ON command; the read/write data can be calculated refer to below process:

Get the exponent of  $V_{in}$ , -3; whose binary is 11101

$$\text{Mantissa} = V_{in} / 2^{(-3)} = 34 / 2^{(-3)} = 272;$$

Converter the calculated Mantissa to hexadecimal 110, then converter to binary 00100010000; Combine the exponent and the mantissa, 11101 and 00100010000; Converter binary 1110100100010000 to hexadecimal E910.

## SUPPORTED PMBUS COMMANDS

The main PMBus commands described in the PMBus 1.2 specification are supported by the module. Partial PMBus commands are fully supported; Partial PMBus commands have difference with the definition in PMBus 1.2 specification. All the supported PMBus commands are detail summarized in below table

Command	Command Code	Command description	Transfer type	Compatible with standard PMBUS or not?	Data Format	Default value	Range limit	Data units	Exponent	Note
OPERATION	0x01	Turn the module on or off by PMBUS command	R/W byte	Refer to below description;	Bit field	0x80	/	/	/	/
ON_OFF_CONFIG	0x02	Configures the combination of primary on/off pin and PMBUS command	R/W byte	Not support turn off delay and fall time setup	Bit field	0x1D	/	/	/	0x1D (Neg Logic); 0x1F (Pos Logic);
CLEAR_FAULTS	0x03	Clear any fault bits that have been set	Send byte	Yes	/	/	/	/	/	/
WRITE_PROTECT	0x10	Control writing to the PMBUS device.	R/W byte	Yes	/	0x80	/	/	/	The intent of this command is to provide protection against accidental changes.
STORE_DEFAULT_ALL	0x11	Stores operating parameters from RAM to data flash	Send byte	Yes	/	/	/	/	/	The FLASH must be unlocked (referring to Command 0xEC) before sending this command. This command is effective to the parameter of all command in the table except 0xEC.
RESTORE_DEFAULT_ALL	0x12	Restores operating parameters from data flash to RAM	Send byte	Yes	/	/	/	/	/	This command can't be issued when the power unit is running.
VOUT_MODE	0x20	Read Vo data format	Read byte	Yes	mode+exp	0x17	/	/	/	/
VOUT_COMMAND	0x21	Set the output voltage normal value	R/W word	Yes	Vout Linear	28	23~33	Volts	-9	/
VOUT_MARGIN_HIGH	0x25	Set the output voltage margin high value	R/W word	Yes	Vout Linear	28.56	23~33	Volts	-9	/
VOUT_MARGIN_LOW	0x26	Set the output voltage margin low value	R/W word	Yes	Vout Linear	27.44	23~33	Volts	-9	/
FREQUENCY_SWITCH	0x33	Set the switching frequency	R/W word	Yes	Frequency linear	120	110~180	KHz	-2	Write command need module off condition
VIN_ON	0x35	Set the turn on voltage threshold of Vin under voltage lockout	R/W word	Yes	Vin Linear	35	32~36	V	-3	VIN_ON should be higher than VIN_OFF
VIN_OFF	0x36	Set the turn off voltage threshold of Vin under voltage lockout	R/W word	Yes	Vin Linear	33	30~34	V	-3	VIN_ON should be higher than VIN_OFF
VOUT_OV_FAULT_LIMIT	0x40	Set the output overvoltage fault threshold.	R/W word	Yes	Vout Linear	34	32~35	V	-9	Must be higher than the value of VOUT_COMMAND and VOUT_OV_WARN_LIMIT;
VOUT_OV_FAULT_RESPONSE	0x41	Instructs what action to take in response to an output overvoltage fault.	Read byte	Refer to below description;	Bit field	0xB8	/	N/A	/	Default Hiccup mode
VOUT_OV_WARN_LIMIT	0x42	Set a threshold causing an output voltage high warning.	R/W word	Yes	Vout Linear	32	31~34	V	-9	Must be the same or less than VOUT_OV_FAULT_LIMIT value
IOUT_OC_FAULT_LIMIT	0x46	Set the output overcurrent fault threshold.	R/W word	Yes	Iout Linear	21	17.6~24	A	-4	Must be greater than IOUT_OC_WARN_LIMIT value
IOUT_OC_FAULT_RESPONSE	0x47	Instructs what action to take in response to an output overcurrent fault.	Read byte	Refer to below description;	Bit field	0xF8	/	N/A	/	Default Hiccup mode
IOUT_OC_WARN_LIMIT	0x4A	Set a threshold causing an output current high warning.	R/W word	Yes	Iout Linear	17	16.6~23	A	-4	Must be less than IOUT_OC_FAULT_LIMIT value
OT_FAULT_LIMIT	0x4F	Set the over temperature fault threshold.	R/W word	Yes	TEMP Linear	135	25~135	Deg.C	-2	Must be greater than OT_WARN_LIMIT value
OT_FAULT_RESPONSE	0x50	Instructs what action to take in response to an over temperature fault.	Read byte	Refer to below description;	Bit field	0xB8	/	N/A	/	Default Hiccup mode
OT_WARN_LIMIT	0x51	Set a threshold causing a temperature high warning.	R/W word	Yes	TEMP Linear	110	25~135	Deg.C	-2	Must be less than OT_FAULT_LIMIT value

Command	Command Code	Command description	Transfer type	Compatible with standard PMBUS or not?	Data Format	Default value	Range limit	Data units	Exponent	Note
POWER_GOOD_ON	0x5E	Sets the output voltage at which the bit 3 of STATUS_WORD high byte should be asserted.	R/W word	Yes	Vout Linear	25	18~31	V	-9	Must be greater than POWER_GOOD_OFF value
POWER_GOOD_OFF	0x5F	Sets the output voltage at which the bit 3 of STATUS_WORD high byte should be negated.	R/W word	Yes	Vout Linear	20	18~31	V	-9	Must be less than POWER_GOOD_ON value
TON_DELAY	0x60	Sets the time from a start condition is received until the output voltage starts to rise	R/W word	Yes	Time Linear	80	20~200	ms	-1	/
TON_RISE	0x61	Sets the time from the output starts to rise until the voltage has entered the regulation band.	R/W word	Yes	Time Linear	40	15~200	ms	-1	/
STATUS_WORD	0x79	Returns the information with a summary of the module's fault/warning	Read word	Refer to below description;	Bit field	/	/	/	/	/
STATUS_VOUT	0x7A	Returns the information of the module's output voltage related fault/warning	R/W byte	Refer to below description;	Bit field	/	/	/	/	/
STATUS_IOUT	0x7B	Returns the information of the module's output current related fault/warning	R/W byte	Refer to below description;	Bit field	/	/	/	/	/
STATUS_INPUT	0x7C	Returns the information of the module's input over voltage and under voltage fault	R/W byte	Refer to below description;	Bit field	/	/	/	/	/
STATUS_TEMPERATURE	0x7D	Returns the information of the module's temperature related fault/warning	R/W byte	Refer to below description;	Bit field	/	/	/	/	/
STATUS_CML	0x7E	Returns the information of the module's communication related faults.	R/W byte	Refer to below description;	Bit field	/	/	/	/	/
READ_VIN	0x88	Returns the input voltage of the module	Read word	Yes	Vin Linear	/	/	V	-3	/
READ_VOUT	0x8B	Returns the output voltage of the module	Read word	Yes	Vout Linear	/	/	V	-9	/
READ_IOUT	0x8C	Returns the output current of the module	Read word	Yes	Iout Linear	/	/	A	-4	/
READ_TEMPERATURE_1	0x8D	Returns the module's hot spot temperature of the module	Read word	Yes	TEMP Linear	/	/	Deg. C	-2	/
PMBUS_REVISION	0x98	Reads the revision of the PMBus	Read byte	Yes	Bit field	0x22	/	/	/	/
MFR_C1_C2_ARA_CONFIG	0xE0	Config C2 pin function	R/W byte	Refer to below description;	Bit field	0x00	/	/	/	/
MFR_C2_Configure	0xE1	Config C2 pin logic	R/W byte	Refer to below description;	Bit field	0x00	/	/	/	/
MFR_PGOOD_POLARITY	0xE2	Config Power Good logic	R/W byte	Refer to below description;	Bit field	0x01	/	/	/	Default Positive PGOOD logic
MFR_SERIAL	0x9E	Reads the SN of module	Read block	/	Total 11 ASCII characters	'xxxxxx xxxxx'	/	/	/	The SN number of module use 11 ASCII characters
PMBUS_CMD_FLASH_KEY_WRITE	0xEC	Write the key to unlock the Flash before Storing operating parameters from RAM to data flash	R/W	No	/	0xA5A5 A5A5	/	/	/	A data block:7E,15,DC,42 should be send to unlock the FLASH.

### OPERATION [0x01]

Bit number	Purpose	Bit Value	Meaning	Default Settings, 0x80
7:	Enable/Disable the module	1	Output is enabled	1
		0	Output is disabled	
6:	Reserved			0
5:4	Margins	00	No margin	00
		01	Margin low(Act on Fault)	
		10	Margin high(Act on Fault)	
3:0	Reserved			0000

### VOUT\_OV\_FAULT\_RESPONSE [0x41]

Bit number	Purpose	Bit Value	Meaning	Default Settings, 0xB8
7:6	Response settings	10	Unit shuts down and responds according to the retry settings	10
5:3	Retry setting	111	Unit continuously restarts while fault is present until commanded off	111
		000	Unit does not attempt to restart on fault	
2:0	Delay time setting	000	No delay supported	000

### IOUT\_OC\_FAULT\_RESPONSE [0x47]

Bit number	Purpose	Bit Value	Meaning	Default Settings, 0xF8
7:6	Response settings	11	Unit shuts down and responds according to the retry settings	11
5:3	Retry settings	111	Unit continuously restarts while fault is present until commanded off	111
		000	Unit does not attempt to restart on fault	
2:0	Delay time setting	000	No delay supported	000

### OT\_FAULT\_RESPONSE [0x50]

Bit number	Purpose	Bit Value	Meaning	Default Settings, 0xB8
7:6	Response settings	10	Unit shuts down and responds according to the retry settings	10
5:3	Retry settings	111	Unit continuously restarts while fault is present until commanded off	111
		000	Unit does not attempt to restart on fault	
2:0	Delay time setting	000	No delay supported	000

### STATUS\_WORD [0x79]

#### High byte

Bit number	Purpose	Bit Value	Meaning
7	An output over voltage fault or warning	1	Occurred
		0	No Occurred
6	An output over current fault or warning	1	Occurred
		0	No Occurred
5	An input voltage fault, including over voltage and under voltage	1	Occurred
		0	No Occurred
4	Reserved		
3	Power_Good	1	is negated
		0	ok
2:0	Reserved		

#### Low byte

Bit number	Purpose	Bit Value	Meaning
7	Reserved		
6	OFF (The unit is not providing power to the output, regardless of the reason)	1	Occurred
		0	No Occurred
5	An output over voltage fault	1	Occurred
		0	No Occurred
4	An output over current fault	1	Occurred
		0	No Occurred
3	An input under voltage fault	1	Occurred
		0	No Occurred
2	A temperature fault or warning	1	Occurred
		0	No Occurred
1	CML (A communications, memory or logic fault)	1	Occurred
		0	No Occurred
0	Reserved		



### STATUS\_VOUT [0x7A]

Bit number	Purpose	Bit Value	Meaning
7	Output over voltage fault	1	Occurred
		0	No Occurred
6	Output over voltage warning	1	Occurred
		0	No Occurred
5:0	Reserved		

### STATUS\_IOUT [0x7B]

Bit number	Purpose	Bit Value	Meaning
7	Output over current fault	1	Occurred
		0	No Occurred
6	Reserved		
5	Output over current warning	1	Occurred
		0	No Occurred
4:0	Reserved		

### STATUS\_INPUT [0x7C]

Bit number	Purpose	Bit Value	Meaning
7	Input over voltage fault	1	Occurred
		0	No Occurred
6:5	Reserved		
4	Input under voltage fault	1	Occurred
		0	No Occurred
3:0	Reserved		

### STATUS\_TEMPERATURE [0x7D]

Bit number	Purpose	Bit Value	Meaning
7	Over temperature fault	1	Occurred
		0	No Occurred
6	Over temperature warning	1	Occurred
		0	No Occurred
5:0	Reserved		

### STATUS\_CML [0x7E]

Bit number	Purpose	Bit Value	Meaning
7	Invalid/Unsupported Command Received	1	Occurred
		0	No Occurred
6	Invalid/Unsupported Data Received	1	Occurred
		0	No Occurred
5	Packet Error Check Failed	1	Occurred
		0	No Occurred
4:0	Reserved		

### MFR\_C1\_C2\_ARA\_CONFIG [0xE0]

Bit number	Purpose	Bit Value	Meaning
7:5	Reserved	000	Reserved
4	ARA	0	ARA not functional, module remains at resistor programmed address when SMBLAERT is asserted
3:0	PIN Configuration	0000	C2 pin: POWER_GOOD
		0010	C2 pin: ON/OFF (Secondary)

### MFR\_C2\_Configure [0xE1]

Bit number	Purpose	Bit Value	Meaning
7:2	Reserved	000000	Reserved
1	ON/OFF Configuration	0	Secondary side on/off pin state when mapped to C2 is ignored
		1	AND – Primary and Secondary side on/off
0	Secondary Side ON/OFF Logic	0	Negative Logic (Low Enable: Input < 0.8V wrt Vout(-))
		1	Positive Logic (High Enable: Input > 2.0V wrt Vout(-))

### MFR\_PGOOD\_POLARITY [0xE2]

Bit number	Purpose	Bit Value	Meaning
7:1	Reserved	0000000	Reserved
0	Power Good Logic	0	Negative PGOOD logic
		1	Positive PGOOD logic

## THERMAL CONSIDERATIONS

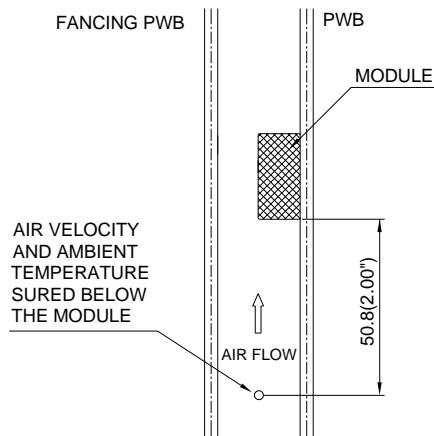
Thermal management is an important part of the system design. To ensure proper, reliable operation, sufficient cooling of the power module is needed over the entire temperature range of the module. Convection cooling is usually the dominant mode of heat transfer.

Hence, the choice of equipment to characterize the thermal performance of the power module is a wind tunnel.

### Thermal Testing Setup

Delta's DC/DC power modules are characterized in heated vertical wind tunnels that simulate the thermal environments encountered in most electronics equipment. This type of equipment commonly uses vertically mounted circuit cards in cabinet racks in which the power modules are mounted.

The following figure shows the wind tunnel characterization setup. The power module is mounted on a test PWB and is vertically positioned within the wind tunnel. The space between the neighboring PWB and the top of the power module is constantly kept at 6.35mm (0.25").



Note: Wind Tunnel Test Setup Figure Dimensions are in millimeters and (Inches)

Figure 17: Wind tunnel test setup

### Thermal Derating

Heat can be removed by increasing airflow over the module. To enhance system reliability, the power module should always be operated below the maximum operating temperature. If the temperature exceeds the maximum module temperature,

## THERMAL CURVES (ATTACH TO COLD PLATE)

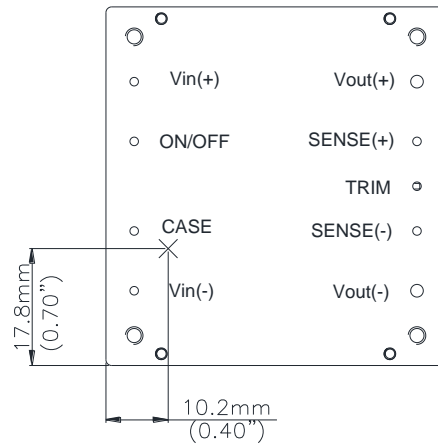


Figure 18: \*Temperature measurement location viewed from top side. The allowed maximum hot spot temperature is defined at 100 °C.

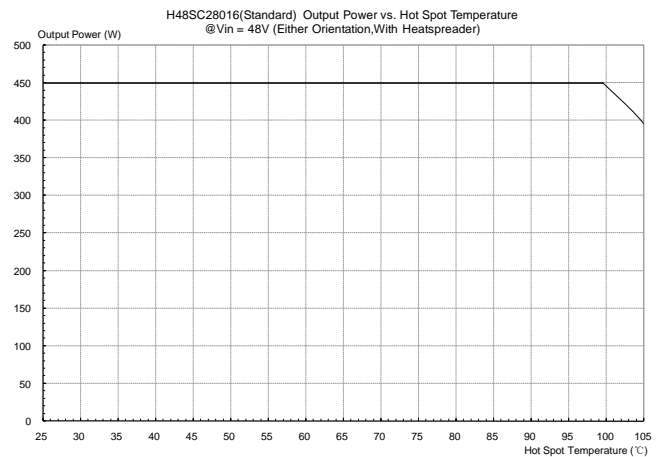
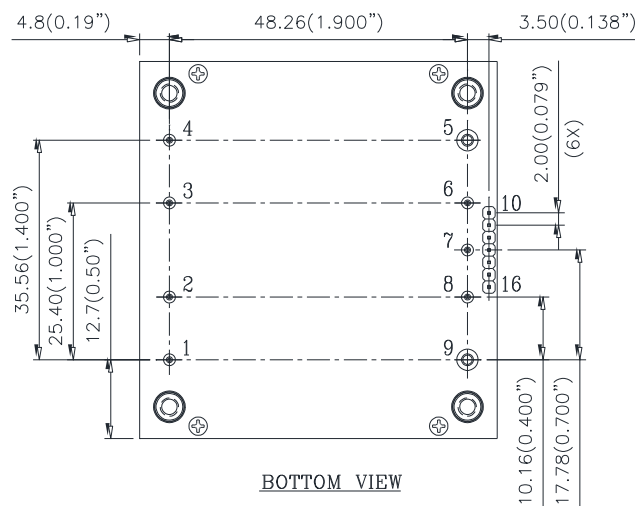
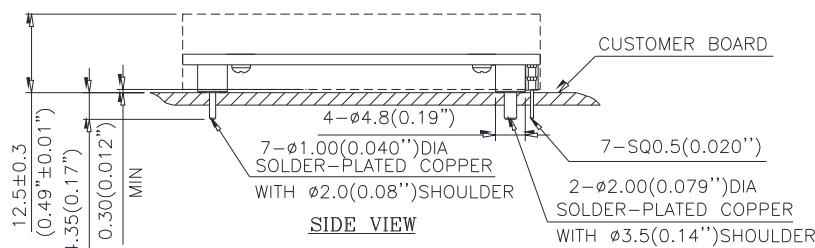
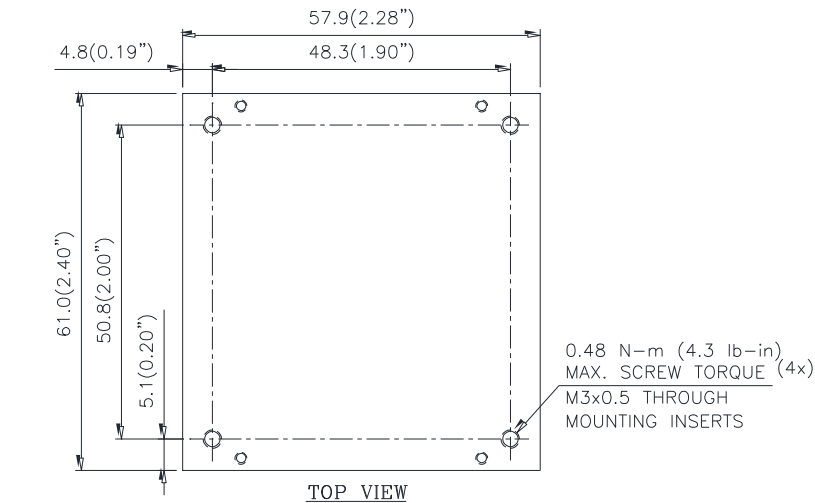


Figure 19: Output power vs. Hot spot temperature @Vin=48V (Either Orientation)

## MECHANICAL DRAWING (WITH HEAT SPREADER)

For modules with through-hole pins and the optional heatspreader, they are intended for wave soldering assembly onto system boards; please do not subject such modules through reflow temperature profile.



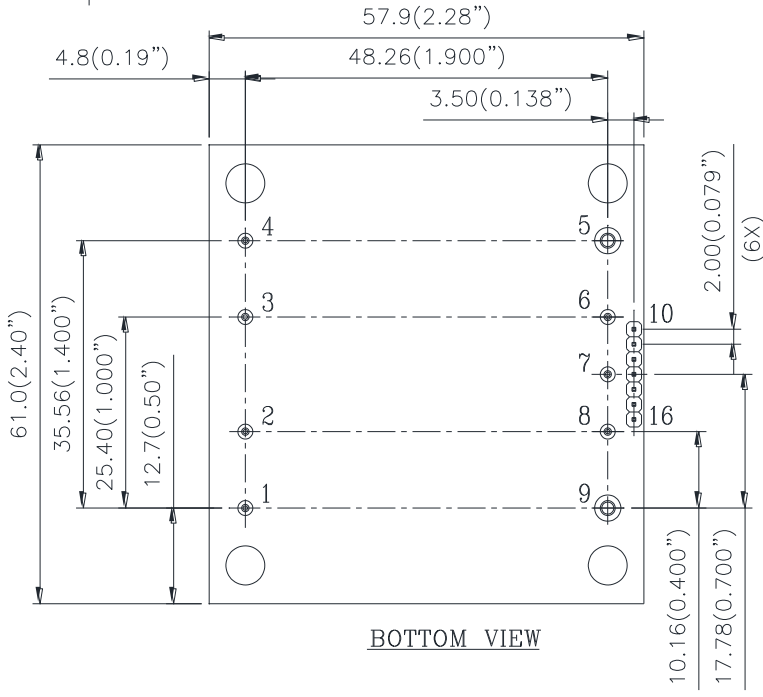
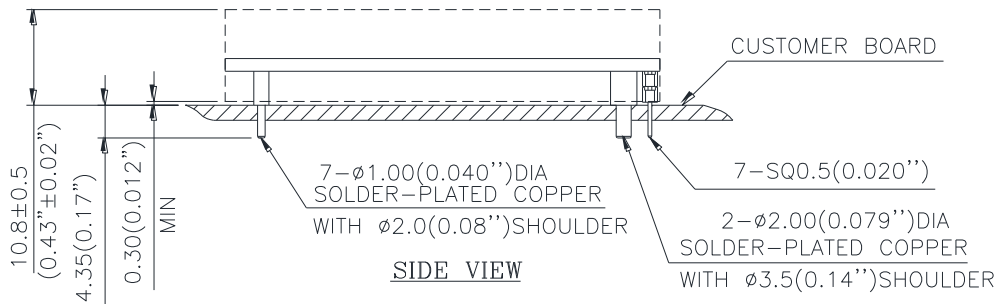
**NOTES:**

DIMENSIONS ARE IN MILLIMETERS AND (INCHES)  
TOLERANCES: X.Xmm±0.5mm(X.XX in.±0.02 in.)  
X.XXmm±0.25mm(X.XXX in.±0.010 in.)

STANDARD	
PIN	NAME
1	Vin(+)
2	ON/OFF
3	Case
4	Vin(-)
5	Vout(-)
6	Sense(-)
7	Trim
8	Sense(+)
9	Vout(+)
10	C2
11	DGND
12	PMBData
13	SMBAlert
14	PMBCLK
15	Addr1
16	Addr0

OPTIONAL

## MECHANICAL DRAWING (WITHOUT HEAT SPREADER)



STANDARD		
PIN	NAME	
1	Vin(+)	
2	ON/OFF	
3	Case	
4	Vin(-)	
5	Vout(-)	
6	Sense(-)	
7	Trim	
8	Sense(+)	
9	Vout(+)	
10	C2	OPTIONAL
11	DGND	
12	PMBData	
13	SMBAlert	
14	PMBCLK	
15	Addr1	
16	Addr0	

NOTES:  
 DIMENSIONS ARE IN MILLIMETERS AND (INCHES)  
 TOLERANCES: X.Xmm±0.5mm(X.XX in.±0.02 in.)  
 X.XXmm±0.25mm(X.XXX in.±0.010 in.)

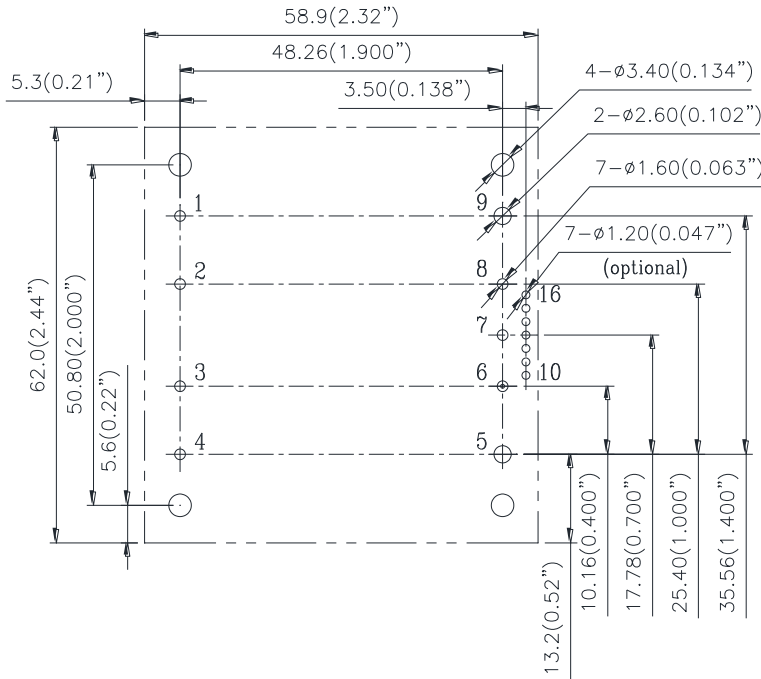
**Pin Specification:**

- Pins 1-4,6-8            1.00mm (0.040") diameter
- Pins 5 & 9             2.00mm (0.079") diameter
- Pins 10~16            0.50mm (0.020") square

Note: All pins are copper alloy with matte Tin(Pb free) plated over Nickel under plating.

**RECOMMENDED LAYOUT**

RECOMMENDED LAYOUT\_QB



STANDARD		
PIN	NAME	
1	Vin(+)	
2	ON/OFF	
3	Case	
4	Vin(-)	
5	Vout(-)	
6	Sense(-)	
7	Trim	
8	Sense(+)	
9	Vout(+)	
10	C2	OPTIONAL
11	DGND	
12	PMBData	
13	SMBAlert	
14	PMBCLK	
15	Addr1	
16	Addr0	

NOTES:

DIMENSIONS ARE IN MILLIMETERS AND (INCHES)  
 TOLERANCES: X.Xmm±0.5mm(X.XX in.±0.02 in.)  
 X.XXmm±0.25mm(X.XXX in.±0.010 in.)



## PART NUMBERING SYSTEM

H	48	S	C	280	16	N	R	F	H		
Form Factor	Input Voltage	Number of Outputs	Product Series	Output Voltage	Output Current	ON/OFF Logic	Pin Length	Pin assignment			
H - Half Brick	48 - 36V~75V	S - Single	C - Series number	280 - 28V	16 - 16A	N - Negative P - Positive	K - 0.110" N - 0.145" R - 0.170"	F - RoHS 6/6 (Lead Free)		PMBUS pin(10~16pin)	Heat spreader
									A	No	No
									B	Yes	No
									C	Yes	Yes
									H	No	Yes

## RECOMMENDED PART NUMBER

MODEL NAME	INPUT		OUTPUT		EFF @ 100% LOAD
H48SC28016NRFH	36V~75V	17A	28V	16A	95.0% @ 48Vin
H48SC28016NRFC	36V~75V	17A	28V	16A	95.0% @ 48Vin

Default remote on/off logic is negative and pin length is 0.170".

For different remote on/off logic and pin length, please refer to part numbering system above or contact your local sales office.

For modules with through-hole pins and the optional heatspreader, they are intended for wave soldering assembly onto system boards; please do not subject such modules through reflow temperature profile.

If need digital pins and PMBus, please contact with Delta.

Website: [www.deltaww.com/dcdc](http://www.deltaww.com/dcdc)

Email: [dcdc@deltaww.com](mailto:dcdc@deltaww.com)

### USA:

Telephone:  
East Coast: 978-656-3993  
West Coast: 510-668-5100  
Fax: (978) 656 3964

### Europe:

Phone: +31-20-655-0967  
Fax: +31-20-655-0999

### Asia & the rest of world:

Telephone: +886 3 4526107  
ext 6221~6226  
Fax: +886 3 4513485

## WARRANTY

Delta offers a two (2) year limited warranty. Complete warranty information is listed on our web site or is available upon request from Delta.

Information furnished by Delta is believed to be accurate and reliable. However, no responsibility is assumed by Delta for its use, nor for any infringements of patents or other rights of third parties, which may result from its use. No license is granted by implication or otherwise under any patent or patent rights of Delta. Delta reserves the right to revise these specifications