



SPECIFICATION SHEET

SPECIFICATION SHEET NO.	P0610- SOT23BT4403S2T
DATE	June 10, 2022
REVISION	A0
DESCRIPTION	SMD Plastic-Encapsulate Transistors, SOT-23 series, 3 pads MMBT4403 Type, PNP, Collector-Emitter Voltage 40V Collector Current 600mA Max. Operating Temp. Range -55°C ~+150°C, Package in Tape/Reel, 3000pcs/Reel RoHS/RoHS III compliant
CUSTOMER	
CUSTOMER PART NUMBER	
CROSS REF. PART NUMBER	
ORIGINAL PART NUMBER	MDD MMBT4403
PART CODE	SOT23BT4403S2T

VENDOR APPROVE		
Issued/Checked/Approved		
		
DATE: June 10, 2022		

CUSTOMER APPROVE	
DATE:	
6/13/2022	

6/13/2022

SMD PLASTIC-ENCAPULATE TRANSISTORS SOT23 SERIES

MAIN FEATURE

- Switching Transistor
- Collector Power Dissipation 300mW
- Collector Current -600mA.



APPLICATION

- For printed circuit board

RFQ

[Request For Quotation](#)

PART CODE GUIDE

SOT23	BT4403	S	2T
1	2	3	4

- 1) **SOT23**: SMD Plastic-Encapsulate Transistors, 3 pads SOT-23 series Code
- 2) **BT4403**: Type code for MMBT4403
- 3) **S**: Package code, Package in Tape/Reel, 3000pcs/Reel
- 4) **2T**: Marking code for “2T” on the case surface, Different Marking for different specification.

SMD PLASTIC-ENCAPULATE TRANSISTORS SOT23 SERIES

DIMENSION (Unit: Inch/mm)

Image for reference

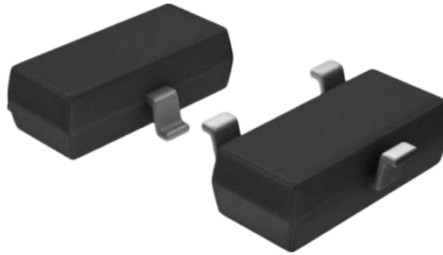

Marking: 2T

SOT-23

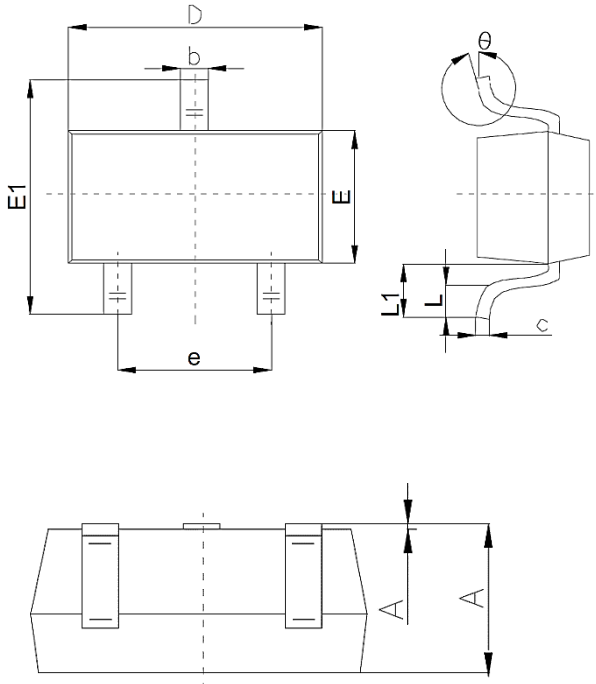

Symbol	Value (mm)		
	Min.	Typ.	Max.
A	0.9		1.4
A1			0.10
b	0.30		0.50
c	0.08		0.20
D	2.80	2.90	3.10
E	1.20		1.60
E1	2.25		2.80
e	1.80	1.90	2.00
L	0.10		0.50
L1	0.40		0.55
θ	0°		10°

Recommend Pad Layout

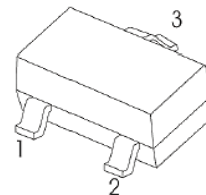
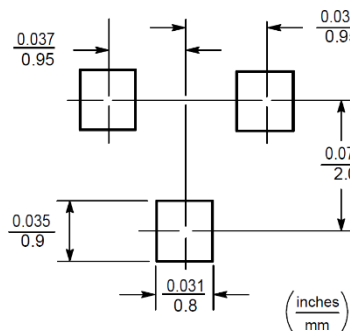

- 1.Base
- 2.Emmitter
- 3.Collector

SMD PLASTIC-ENCAPULATE TRANSISTORS SOT23 SERIES
MECHANICAL DATA

Case	Terminals	Polarity	Mounting Position	Weight per piece
JEDEC SOT-23 molded plastic body	Solder plated, Solderable per MIL-STD-750, Method 2026	Polarity symbol marking on case	Any	0.00019 Ounce, 0.00591 grams

MAX. RATINGS AT Ta=25 °C

Parameter	SYMBOLS	VALUE	UNITS
		LIMIT	
Collector-base Voltage	V _{CBO}	-40	Volts
Collector-emitter Voltage	V _{CEO}	-40	Volts
Emitter-base Voltage	V _{EBO}	-5	Volts
Collector Current	I _C	-600	mA
Collector Power Dissipation	P _C	300	mW
Thermal Resistance Junction To Ambient	R _{QJA}	417	°C/W
Junction Temperature	T _J	+150	°C
Storage Temperature Range	T _{STG}	-55 ~ +150	°C

SMD PLASTIC-ENCAPULATE TRANSISTORS SOT23 SERIES
ELECTRICAL CHARACTERISTICS AT Ta= 25 °C

Parameter	SYMBOLS	VALUE			UNIT	Condition
		Min.	Typ.	Max.		
Collector-base Breakdown Voltage	$V_{(BR)CBO}$	-40			V	$I_C = -100\mu A, I_E = 0$
Collector-emitter Breakdown Voltage	$V_{(BR)CEO}$	-40			V	$I_C = -1mA, I_B = 0$
Emitter-base Breakdown Voltage	$V_{(BR)EBO}$	-5			V	$I_E = -100\mu A, I_C = 0$
Collector Cut-off Current	I_{CBO}			-0.1	μA	$V_{CB} = -35V, I_E = 0$
Collector Cut-off Current	I_{CEX}			-0.1	μA	$V_{CE} = -35V, V_{BE(off)} = -0.4V$
Emitter Cut-off Current	I_{EBO}			-0.1	μA	$V_{EB} = -4V, I_C = 0$
DC Current Gain	$h_{FE(1)}$	30				$V_{CE} = -1V, I_C = -0.1mA$
	$h_{FE(2)}$	60				$V_{CE} = -1V, I_C = -1mA$
	$h_{FE(3)}$	100				$V_{CE} = -1V, I_C = -10mA$
	$h_{FE(4)}$	100		300		$V_{CE} = -2V, I_C = -150mA$
	$h_{FE(5)}$	20				$V_{CE} = -2V, I_C = -500mA$
Collector-emitter Saturation Voltage	$V_{CE(sat)}$			-0.4	V	$I_C = -150mA, I_B = -15mA$
				-0.75	V	$I_C = -500mA, I_B = -50mA$
Base-emitter Saturation Voltage	$V_{BE(sat)}$			-0.95	V	$I_C = -150mA, I_B = -5mA$
				-1.3	V	$I_C = -500mA, I_B = -50mA$
Transition Frequency	f_T	200			MHz	$V_{CE} = -10V, I_C = -20mA, f = 100MHz$
Delay Time	t_d			15	ns	$V_{CC} = -30V, V_{BE(off)} = -0.5V, I_C = -150mA, I_{B1} = -15mA$
Rise Time	t_r			20	ns	
Storage Time	t_s			225	ns	$V_{CC} = -30V, I_C = -150mA, I_{B1} = I_{B2} = -15mA$
Fall Time	t_f			60	ns	

SMD PLASTIC-ENCAPULATE TRANSISTORS SOT23 SERIES
RELIABILITY

Number	Experiment Items	Experiment Method And Conditions	Reference Documents
1	Solder Resistance Test	Test 260°C± 5°C for 10 ± 2 sec. Immerse body into solder 1/16" ± 1/32"	MIL-STD-750D METHOD-2031.2
2	Solderability Test	230°C ±5°C for 5 sec.	MIL-STD-750D METHOD-2026.1 0
3	Pull Test	1 kg in axial lead direction for 10 sec.	MIL-STD-750D METHOD-2036.4
4	Bend Test	0.5Kg Weight Applied To Each Lead, Bending Arcs 90 °C ± 5 °C For 3 Times	MIL-STD-750D METHOD-2036.4
5	High Temperature Reverse Bias Test	TA=100°C for 1000 Hours at VR=80% Rated VR	MIL-STD-750D METHOD-1038.4
6	Forward Operation Life Test	TA=25°C Rated Average Rectified Current	MIL-STD-750D METHOD-1027.3
7	Intermittent Operation Life Test	On state: 5 min with rated IRMS Power Off state: 5 min with Cool Forced Air. On and off for 1000 cycles.	MIL-STD-750D METHOD-1036.3
8	Pressure Cooker Test	15 PSIG, TA=121°C, 4 hours	MIL-S-19500 APPENOIXC
9	Temperature Cycling Test	-55°C~+125°C; 30 Minutes For Dwelled Time 5 minutes for transferred time. Total: 10 cycles.	MIL-STD-750D METHOD-1051.7
10	Thermal Shock Test	0°C for 5 minutes., 100°C for 5minutes, Total: 10 cycles	MIL-STD-750D METHOD-1056.7
11	Forward Surge Test	8.3ms Single Sale Sine-wave One Surge.	MIL-STD-750D METHOD-4066.4
12	Humidity Test	TA=65°C, RH=98% for 1000 hours.	MIL-STD-750D METHOD-1021.3
13	High Temperature Storage life Test	150°C for 1000 Hours	MIL-STD-750D METHOD-1031.5

SMD PLASTIC-ENCCAPULATE TRANSISTORS SOT23 SERIES

SUGGESTED REFLOW PROFILE (For Reference Only)

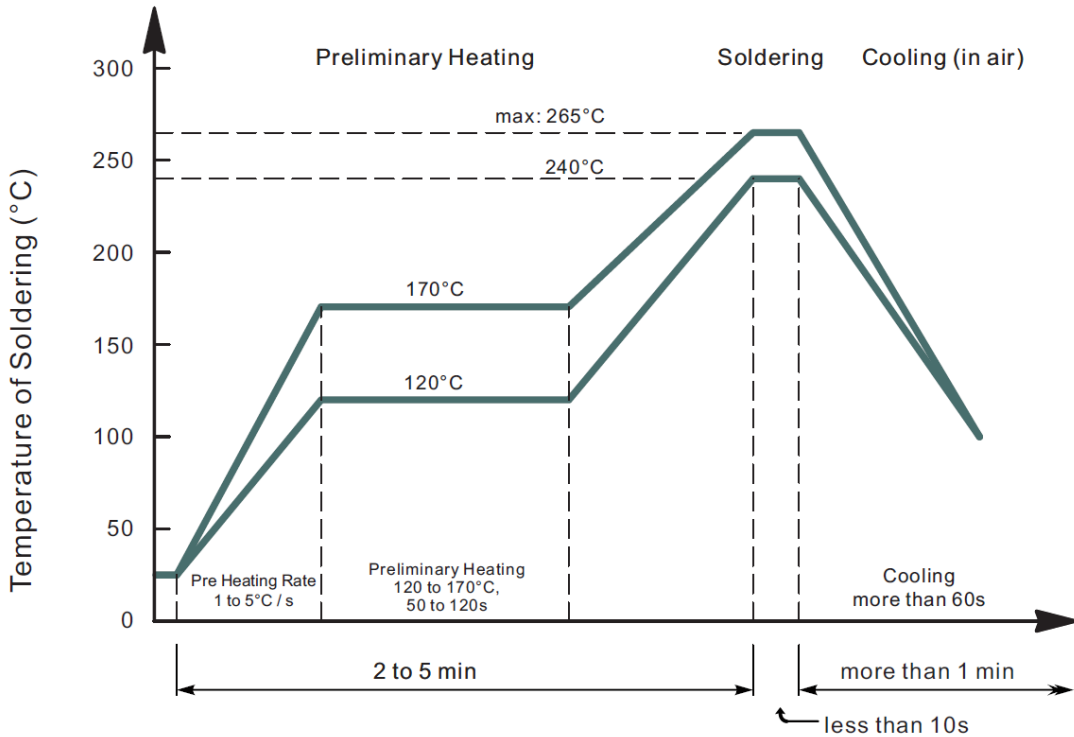

- Recommended peak temperature is over 245°C, If peak temperature is below 245 °C, you may adjust the following parameters; time length of peak temperature (longer), time length of soldering (longer), thickness of solder paste (thicker)
- Welding shall not exceed 2 times
- Remark: lead free solder paste (96.5 sn/3.0 Ag/0.5Cu)

SMD PLASTIC-ENCAPULATE TRANSISTORS SOT23 SERIES

RATINGS AND CHARACTERISTIC CURVES (For Reference Only)

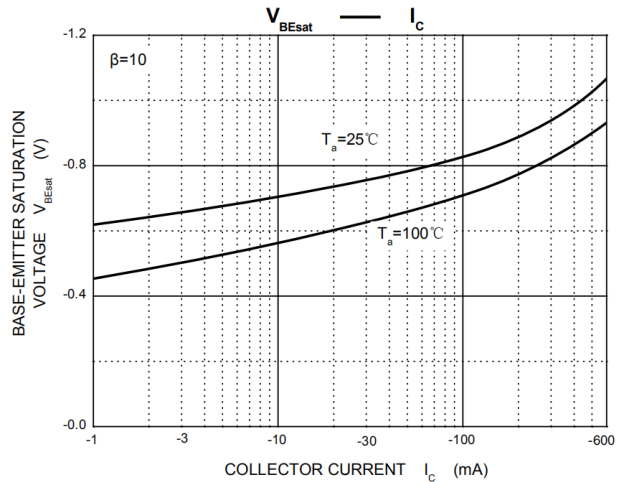
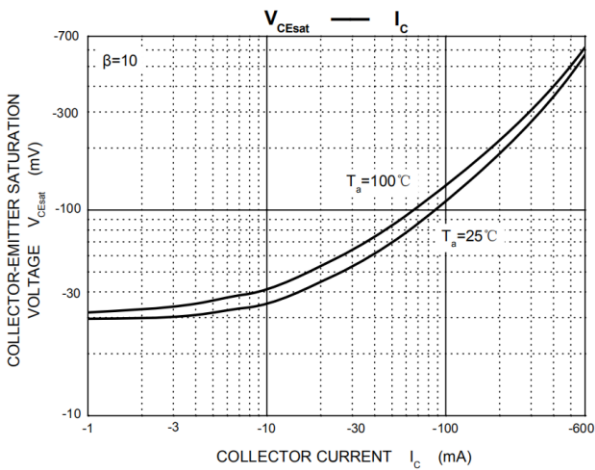
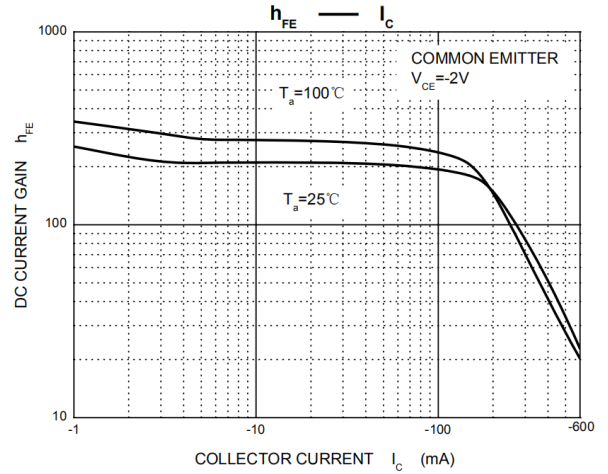
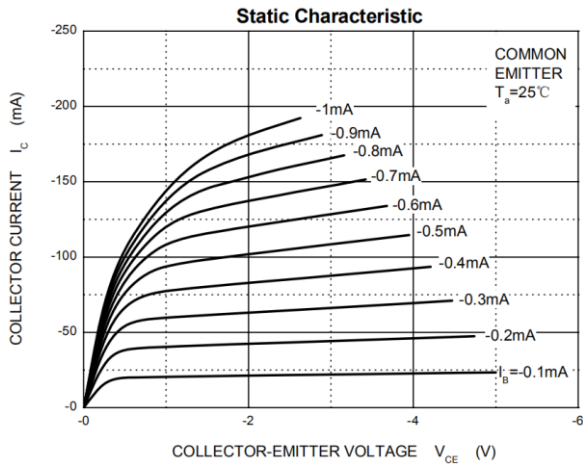

SMD PLASTIC-ENCAPULATE TRANSISTORS SOT23 SERIES

RATINGS AND CHARACTERISTIC CURVES (For Reference Only)

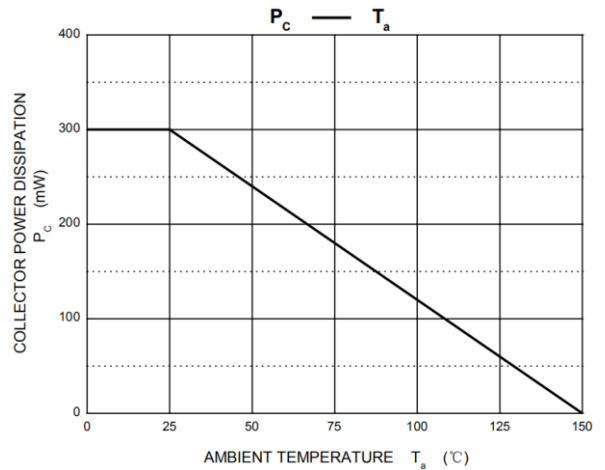
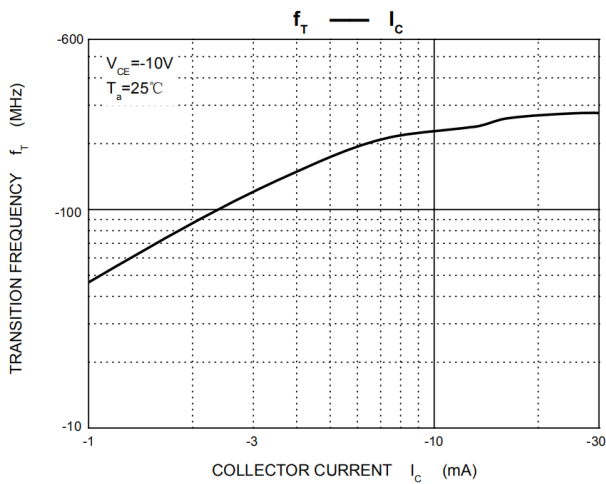
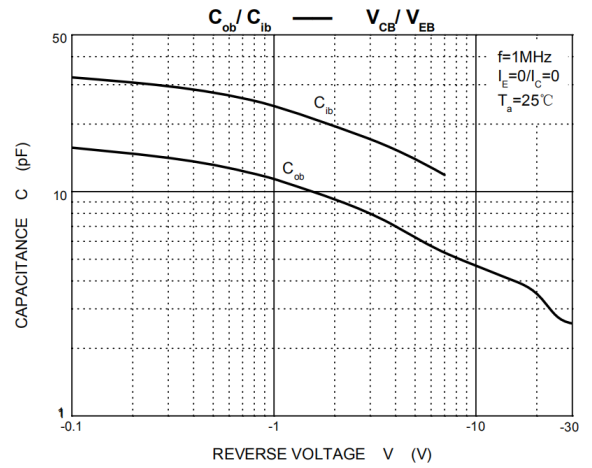
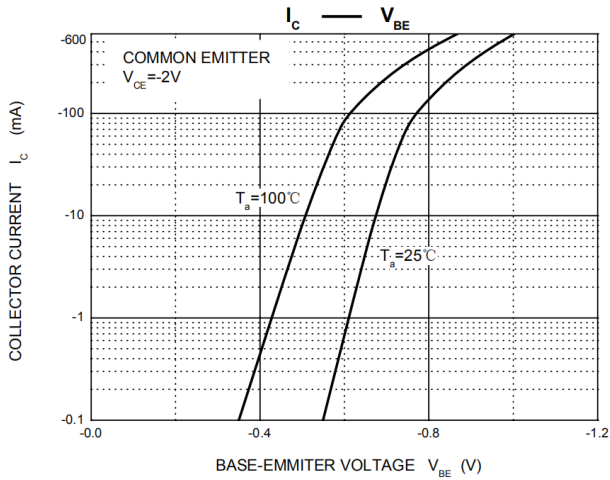

SMD PLASTIC-ENCAPULATE TRANSISTORS SOT23 SERIES
TAPE/REEL (Unit: mm)

All Devices are packed in accordance with EIA standard RS-481-A and specifications.

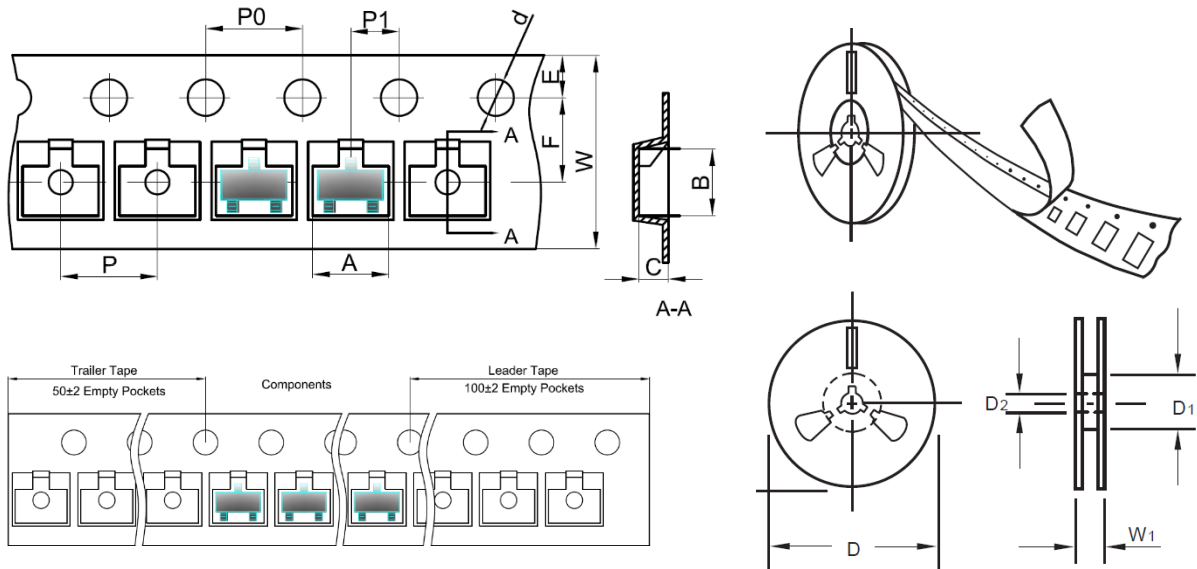

Item	Symbol	Tolerance	SOT-23
Carrier width	A	0.1	3.15
Carrier Length	B	0.1	2.77
Carrier Depth	C	0.1	1.22
Sprocket hole	d	0.05	1.55
7" Reel outside diameter	D	2.0	178.00
7" Reel inner diameter	D1	Min.	54.4
Feed hole diameter	D2	0.5	13.00
Sprocket hole position	E	0.1	1.75
Punch hole position	F	0.1	3.50
Punch hole pitch	P	0.1	4.00
Sprocket hole pitch	P0	0.1	4.00
Embossment center	P1	0.1	2.00
Overall tape thickness	T	0.1	0.25
Tape width	W	0.3	8.00
Reel width	W1	1.0	19.50

SMD PLASTIC-ENCAPULATE TRANSISTORS SOT23 SERIES

PACKAGE

Case Code	SOT-23
Reel Size	7"
Reel Size	178 mm
MPQ/Reel	3000 pcs
Qty. /Box	6000 pcs
G.W/Box	1 LBS

DISCLAIMER

NextGen Component, Inc. reserves the right to make changes to the product(s) and or information contained herein without notice. No liability is assumed as a result of their use or application. No rights under any patent accompany the sale of any such product(s) or information