

# Bridgelux® Vesta™ Tunable Linear Gen 3 Thrive 1 SMD Row

Product Data Sheet DS137

Lengths: 280mm, 560mm, 1120mm

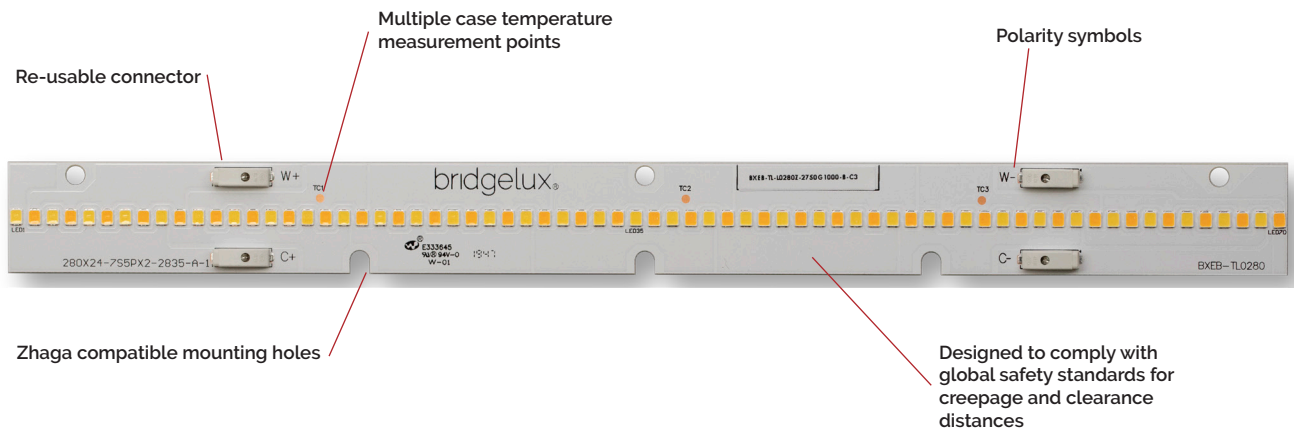
CRIs: 98 Thrive

CCT Ranges: 2700K-5000K, 2700K-6500K



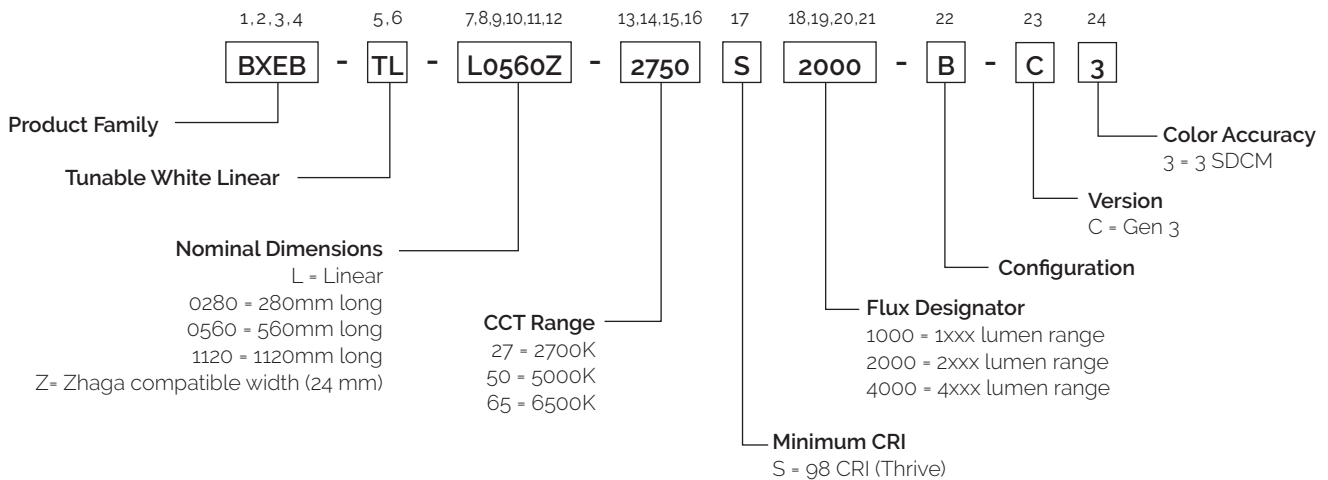
# Product Feature Map

Bridgelux Vesta Series Tunable White Linear (TL) modules are fully engineered devices that provide consistent thermal and optical performance on an engineered mechanical platform. The linear products incorporate several features to simplify design integration and assembly. Please visit [www.bridgelux.com](http://www.bridgelux.com) for more information on the Vesta Series family of products.



## Product Nomenclature

The part number designation for Bridgelux Vesta Series TL Gen 3 Thrive with 1 SMD row is explained as follows:



# Product Selection Guide

**Table 1: Product Performance ( $T_c = 25^\circ\text{C}$ )**

Part Number	Nominal CCT <sup>1</sup> (K)	Minimum CRI	Typical Flux <sup>2,3</sup> (lm)	Nominal Drive Current (mA)	Typical $V_f$ (V)	Typical Power (W)	Typical Efficacy (lm/W)
BXEB-TL-L0280Z-2750S1000-B-C3	2700	98	740	300	20.3	6.1	122
	5000		840				138
BXEB-TL-L0280Z-2765S1000-B-C3	2700		740				122
	6500		840				138
BXEB-TL-L0560Z-2750S2000-B-C3	2700	98	1480	600	20.3	12.2	122
	5000		1680				138
BXEB-TL-L0560Z-2765S2000-B-C3	2700		1480				122
	6500		1680				138
BXEB-TL-L1120Z-2750S4000-B-C3	2700	98	2960	600	40.6	24.4	122
	5000		3360				138
BXEB-TL-L1120Z-2765S4000-B-C3	2700		2960				122
	6500		3360				138

Notes for Table 1:

1. Nominal CCT as defined by ANSI C78.377-2011.
2. Data is at nominal test current where temperature of center case temperature point  $T_c = 25^\circ\text{C}$ .
3. Bridgelux maintains a  $\pm 7\%$  tolerance on typical flux data (typical SMD flux bins)

# Thrive Color Metrics

**Table 2: Average Spectral Difference & Color Rendering**

CCT	ASD	TM-30		CRI																
		Rf	Rg	Ra	R1	R2	R3	R4	R5	R6	R7	R8	R9	R10	R11	R12	R13	R14	R15	
2700K	11%	96	100	98	97	98	99	96	96	94	98	98	95	96	93	92	96	99	99	
3000K	10%	97	100	98	97	98	98	97	97	96	99	99	97	98	94	96	97	98	99	
3500K	11%	97	101	98	99	98	95	98	98	97	98	97	92	94	97	93	99	96	98	
4000K	9%	97	100	98	99	99	96	98	99	98	99	99	97	96	97	94	99	97	99	
5000K	10%	97	101	98	98	98	100	97	98	97	97	98	96	98	99	90	98	99	96	
5700K	9%	97	100	98	99	99	99	98	98	98	99	98	95	98	97	97	98	99	98	
6500K	8%	97	100	98	99	99	99	99	99	99	99	99	97	98	99	98	99	99	99	

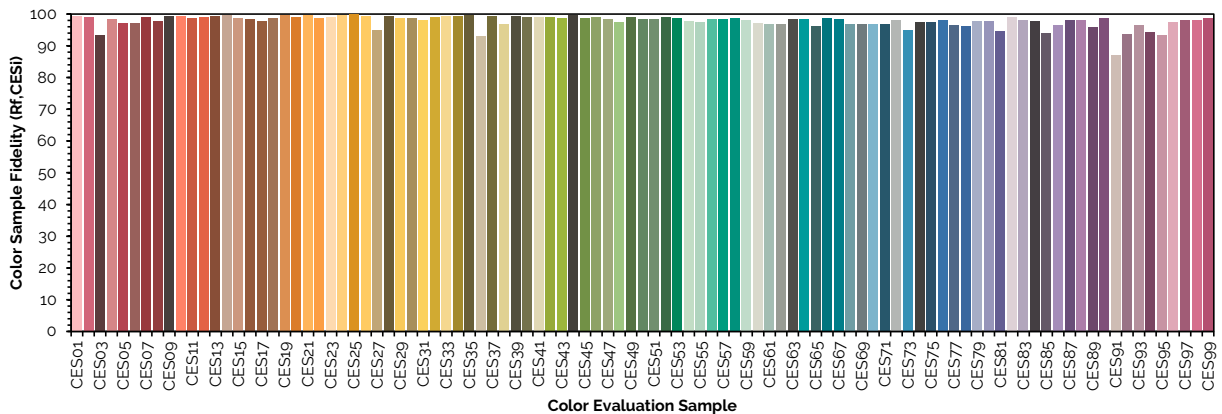
Notes for Table 2:

1. All values are typical measurements at  $T_{sp} = 85^{\circ}C$ , with module drive current of 300mA (280mm) or 600mA (560mm/1120mm)
2. Bridgelux maintains a tolerance of  $\pm 3$  on Color Rendering Index R1-R15 measurements and TM-30 measurements
3. ASD (Average Spectral Difference) is a metric developed by Bridgelux that quantifies the naturalness of a light source by summing the differences between any SPD and a standardized natural light source SPD. For further information, please visit [www.bridgelux.com/products/thrive](http://www.bridgelux.com/products/thrive) and view the Bridgelux ASD White Paper.

## TM-30 Color Sample Fidelity

The following three figures show the 99 Color Evaluation Samples (CES) defined by TM-30 for each module CCT. These are typical measurements at  $T_{sp} = 85^{\circ}C$ , with module drive current of 300mA (280mm) or 600mA (560mm/1120mm)

**Figure 1: 2700K TM-30 Color Sample Fidelity**



# Thrive Color Metrics

Figure 2: 5000K TM-30 Color Sample Fidelity

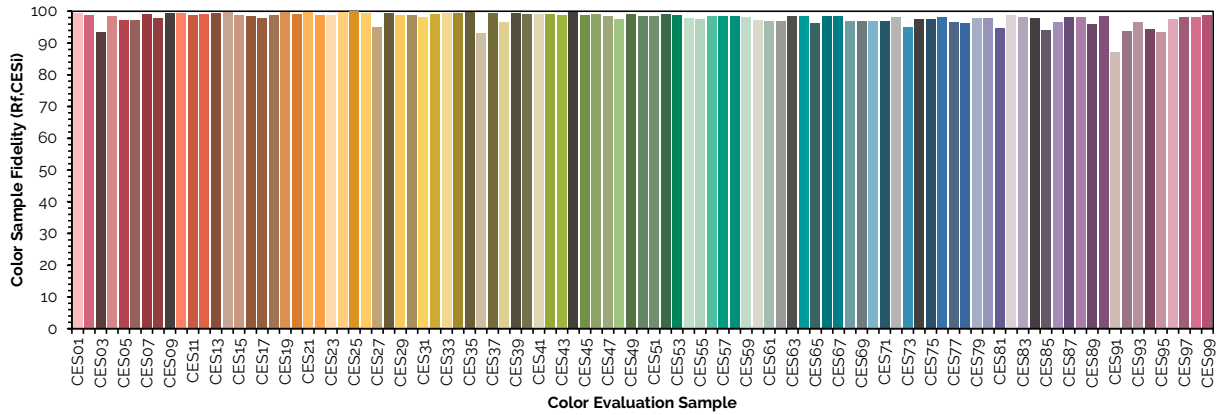
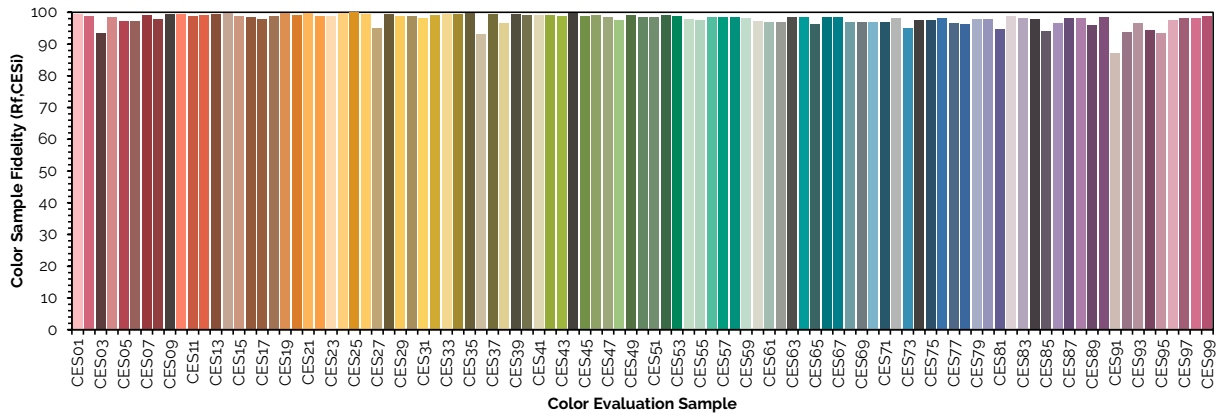


Figure 3: 6500K TM-30 Color Sample Fidelity



# Electrical Characteristics

**Table 3: Electrical Characteristics**

Part Number	Drive Current (mA)	Forward Voltage $T_{c2} = 25^{\circ}\text{C}$ (V) <sup>1, 2, 3</sup>			Typical Coefficient of Forward Voltage <sup>4</sup> $\Delta V_f / \Delta T$ (mV/ $^{\circ}\text{C}$ )	Driver Selection Voltages (V) <sup>5</sup>	
		Minimum	Typical	Maximum		$V_f$ Min, Hot $T_{c2} = 85^{\circ}\text{C}$ (V)	$V_f$ Max, Cold $T_{c2} = -40^{\circ}\text{C}$ (V)
BXEB-TL-L0280Z-27xxS1000-B-C3	300	18.9	20.3	21.7	-5.4	18.6	22.1
	600	20.0	21.5	23.0		20.0	23.0
	750	20.6	22.1	23.6		20.2	24.0
BXEB-TL-L0560Z-27xxS2000-B-C3	600	18.9	20.3	21.7	-5.4	18.6	22.1
	1200	20.0	21.5	23.0		20.0	23.0
	1500	20.6	22.1	23.6		20.2	24.0
BXEB-TL-L1120Z-27xxS4000-B-C3	600	37.8	40.6	43.4	-10.8	37.1	44.1
	1200	40.0	43.0	46.0		40.0	46.0
	1500	41.1	44.2	47.3		40.5	48.0

Notes for Table 3:

1. Voltage minimum and maximum are provided for reference only and are not a guarantee of performance.
2. Bridgelux maintains a tolerance of  $\pm 0.1$  V on forward voltage data.
3. This product has been designed and manufactured per IEC 62031:2018. The working voltage designated for the insulation is 60 Vdc. The maximum allowable voltage across the module must be determined in the end product application.
4. Typical coefficient of forward voltage tolerance is  $\pm 0.1$  mV for nominal current.
5.  $V_f$  min hot and max cold values are provided as reference only and are not guaranteed. These values are provided to aid in driver design and selection over the operating range of the product.

# Absolute Maximum Ratings

**Table 4: Maximum Ratings**

Parameter	Maximum Rating		
Storage Temperature	-40°C to +85°C		
Operating Case Temperature <sup>2</sup> (T <sub>c</sub> )	85°C		
Soldering Temperature	350°C or lower for a maximum of 5 seconds		
Maximum Reverse Voltage	Modules are not designed to be driven in reverse bias		
	BXEB-TL-L0280Z-27xxS1000-B-C3	BXEB-TL-L0560Z-27xxS2000-B-C3	BXEB-TL-L1120Z-27xxS4000-B-C3
Drive Current, Maximum Combined <sup>3</sup>	750 mA	1500 mA	1500 mA
Drive Current, Maximum Per Channel <sup>3</sup>	750 mA	1500 mA	1500 mA

Notes for Table 4:

- For IEC 62717 requirement, please consult your Bridgelux sales representative.
- Lumen maintenance (L70) and lifetime predictions are valid for drive current and case temperature conditions used for LM-80 testing as included in the applicable LM-80 test report for the SMDs used in the modules. Contact your Bridgelux sales representatives for LM-80 report.
- The Maximum Combined Drive Current is defined as the sum of the drive currents in both channels.
  - Example #1: If 750mA is applied to the 2700K (warm white) channel of the BXEB-TL-L0280Z-27xxS1000-B-C3 module, then 0mA may be applied to the alternate cool white channel.
  - Example #2: If 1000mA is applied to the cool white channel of the BXEB-TL-L0560Z-27xxS2000-B-C3 module, then a maximum of 500mA may be applied to the warm white channel.

# Performance Curves

Figure 4: Current vs. Forward Voltage (280mm only)

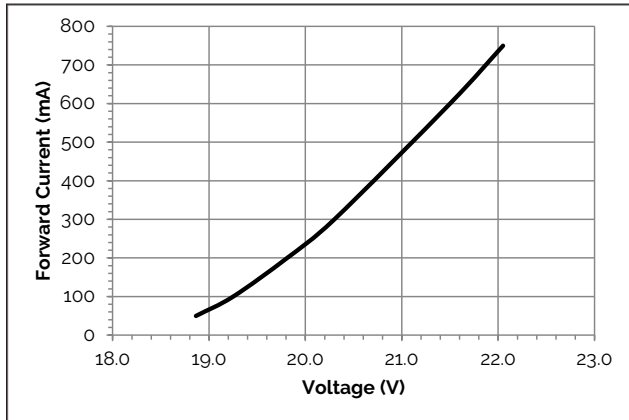


Figure 5: Flux vs. Current (280mm only)

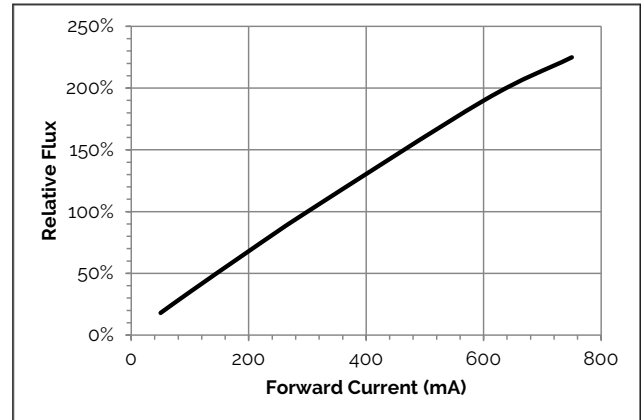


Figure 6: Current vs. Forward Voltage (560mm only)

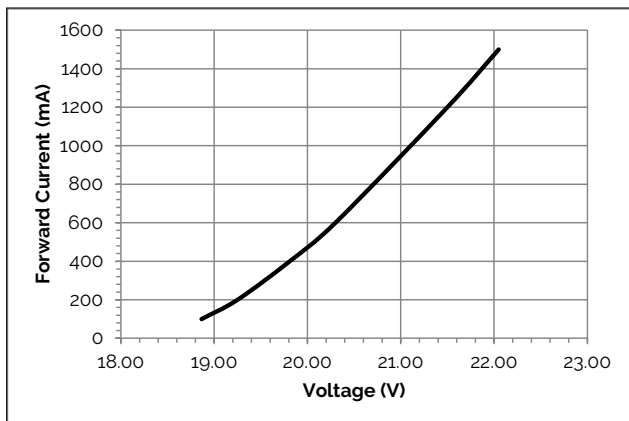


Figure 7: Flux vs. Current (560mm only)

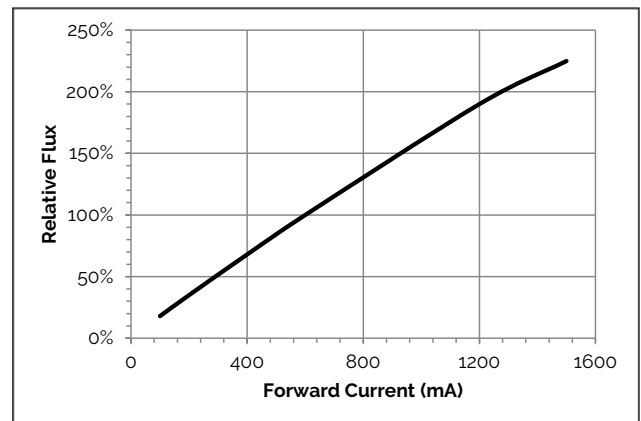


Figure 8: Current vs. Forward Voltage (1120mm only)

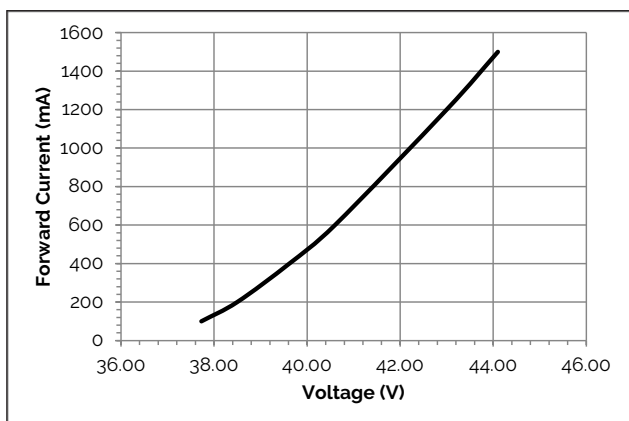
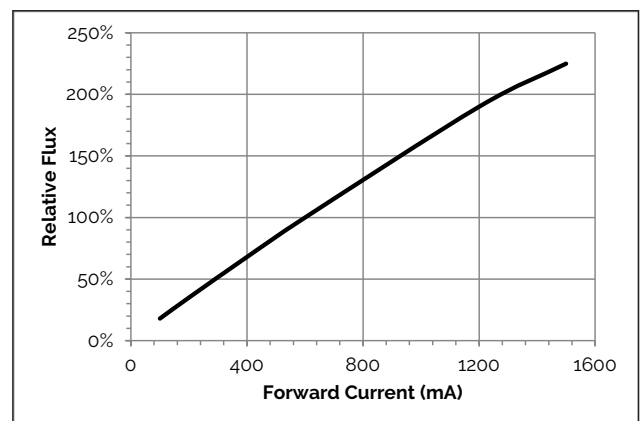


Figure 9: Flux vs. Current (1120mm only)



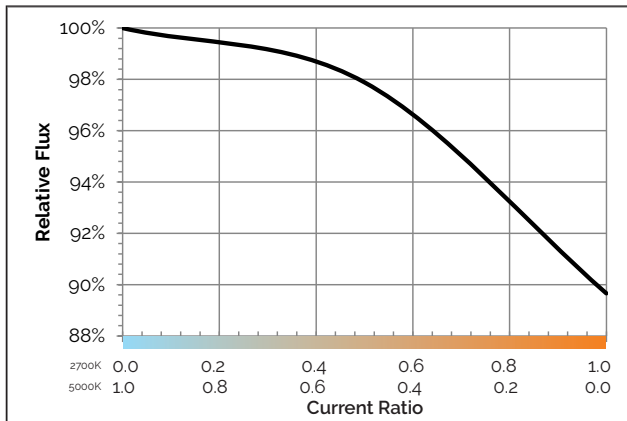
Notes for Figures 4-9:

1. All measurements were performed at  $T_c=25^{\circ}\text{C}$

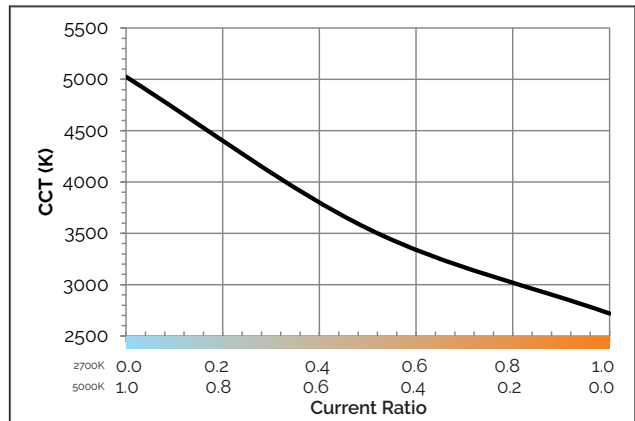


# Performance Curves

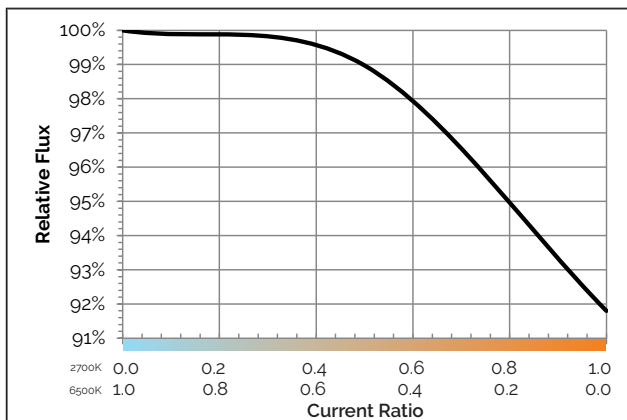
**Figure 10: Flux vs. Current Ratio (2700K-5000K)**



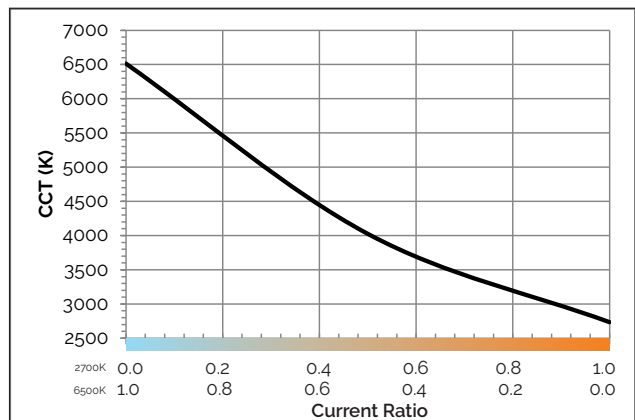
**Figure 11: CCT vs. Current Ratio (2700K-5000K)**



**Figure 12: Flux vs. Current Ratio (2700K-6500K)**



**Figure 13: CCT vs. Current Ratio (2700K-6500K)**

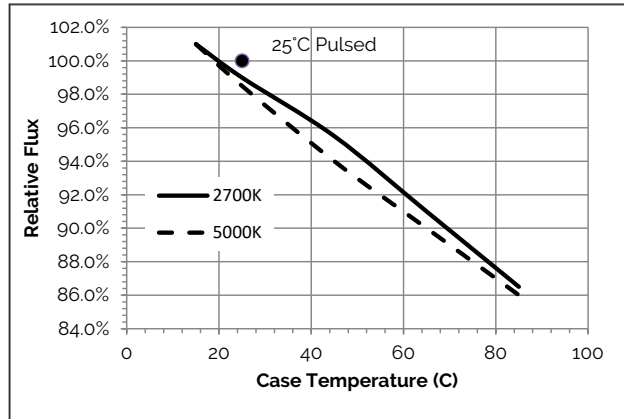


Notes for Figures 10-13:

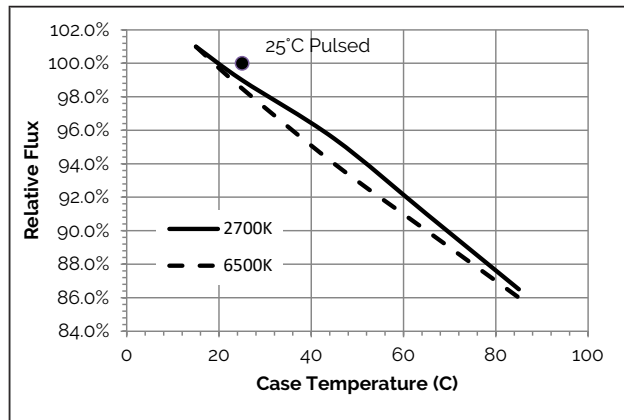
1. All measurements were performed at  $T_c = 25^\circ\text{C}$
2. Current Ratio is calculated by dividing the channel with the lower drive current by the channel with the higher drive current. For example if the CW channel is operated at 1200mA and the WW channel is operated at 300mA, then the WW current ratio =  $300/1200 = 0.25$

# Performance Curves

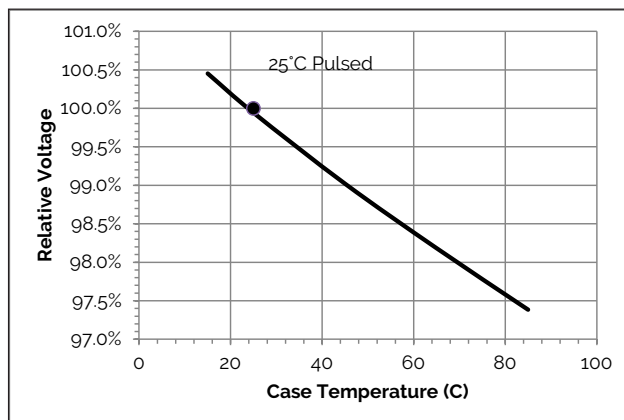
**Figure 14: Flux vs Case Temperature (2700K-5000K)**



**Figure 15: Flux vs Case Temperature (2700K-6500K)**

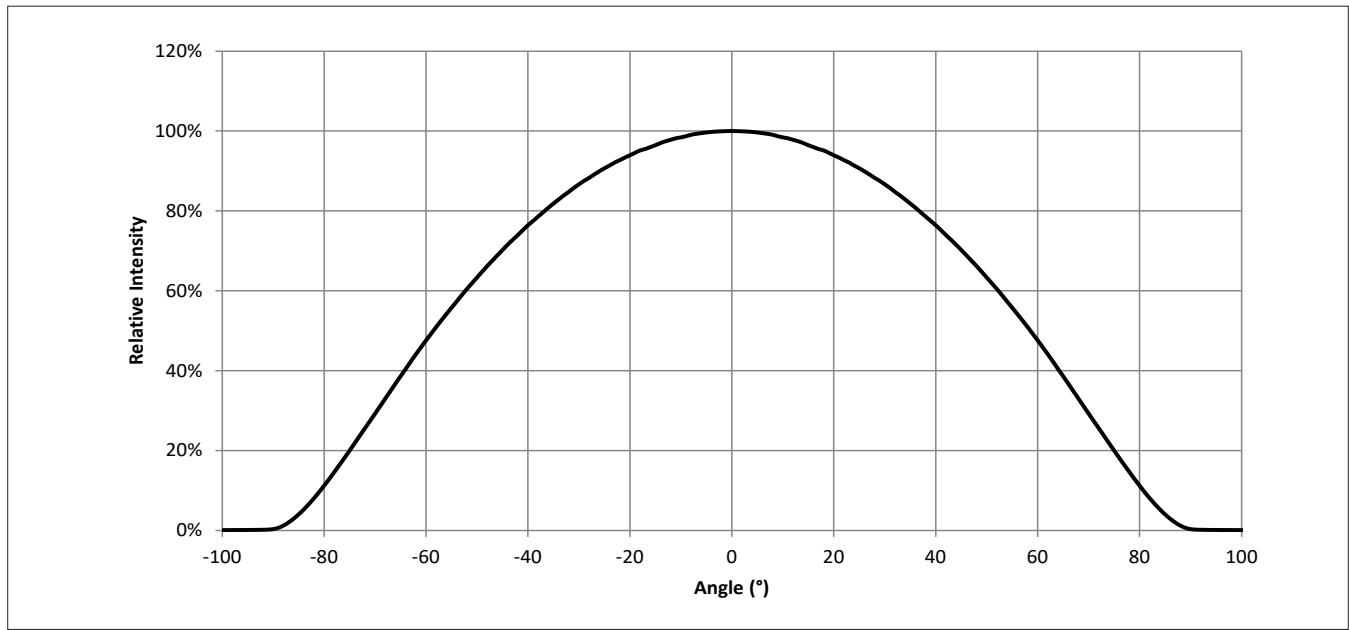


**Figure 16: Voltage vs Case Temperature**



# Typical Radiation Pattern

**Figure 17: Typical Spatial Radiation Pattern**

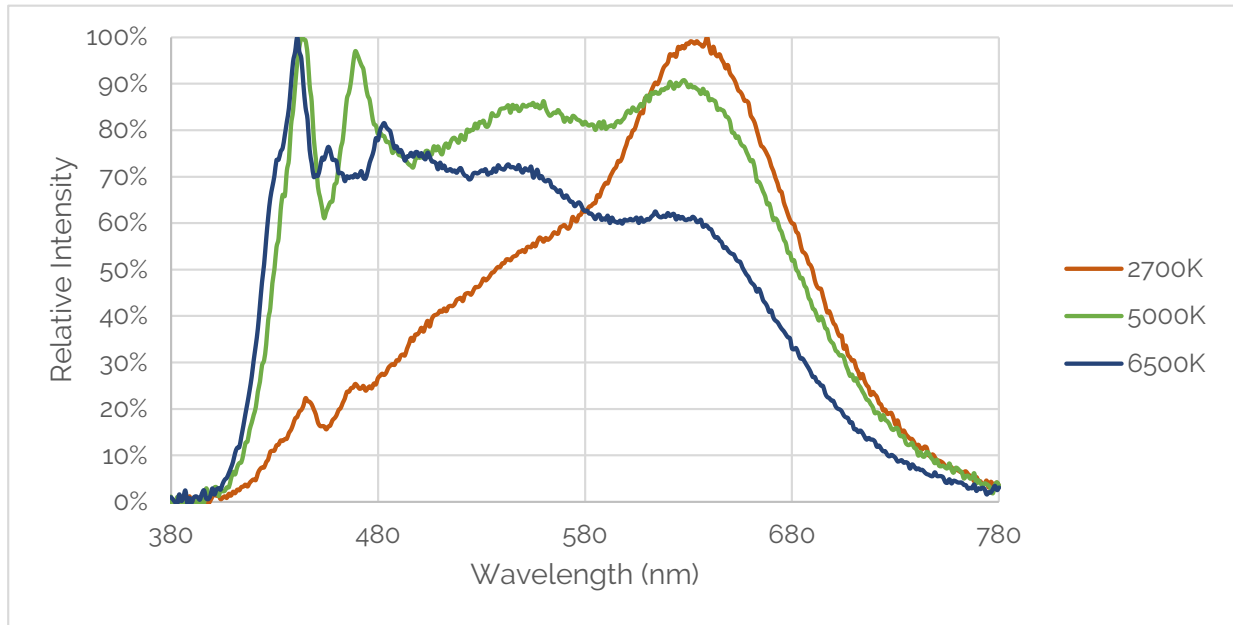


Notes for Figure 17:

1. Typical viewing angle is 120°.FWHM
2. The viewing angle is defined as the full-width off-axis angle where the intensity is 50% of the peak value.

# Typical Color Spectrum

Figure 18: Typical Spectral Power Distribution



Note for Figure 18:

1. Color spectra measured at nominal current for  $T_c = 65^\circ\text{C}$

# Mechanical Dimensions

Figure 19: Drawing Overview for 280mm

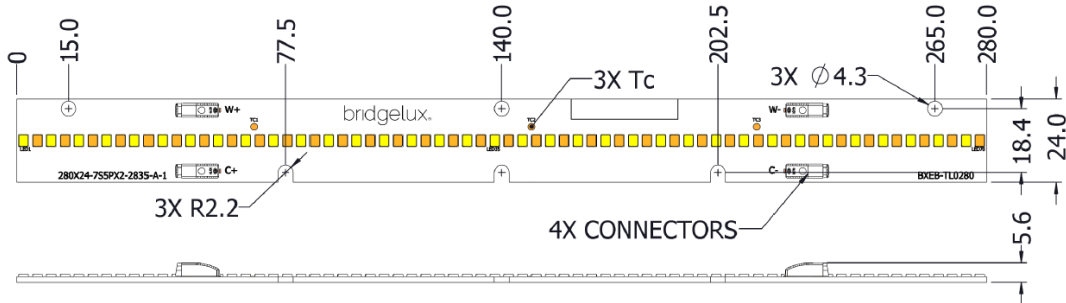


Figure 20: Drawing Overview for 560mm

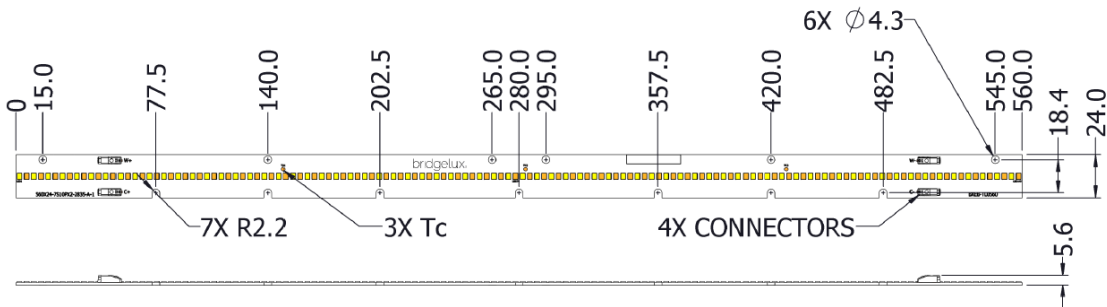
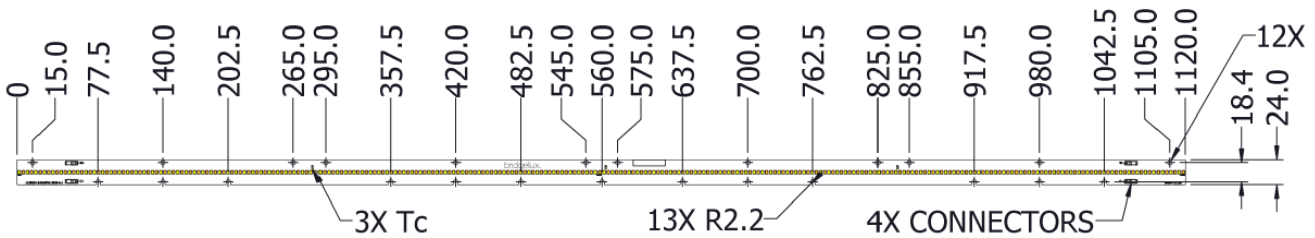


Figure 21: Drawing Overview for 1120mm



Notes for Figures 19-21:

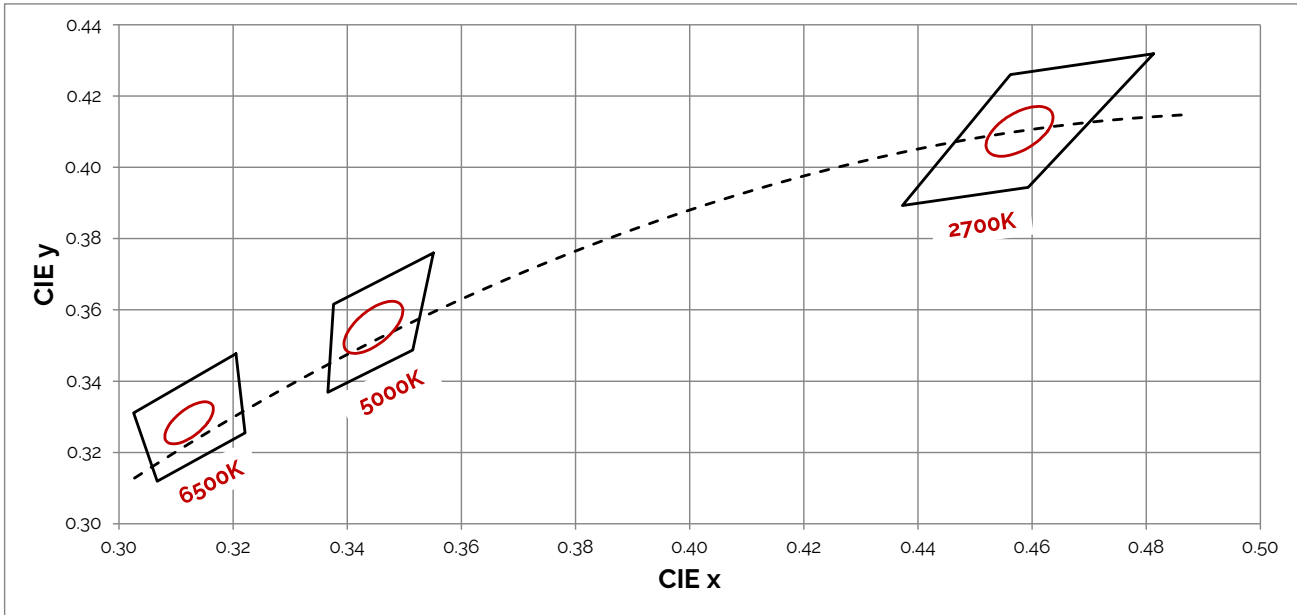
1. Solder pads are labeled "+" to denote positive polarity, and "-" to denote negative polarity.
2. "W" labels stand for Warm White and refer to the low CCT SMDs on the module (i.e. 2700K). "C" labels stand for Cool White and refer to the high CCT SMDs on the module (i.e. 5000K, or 6500K).
3. Dimensions are in millimeters.
4. Refer to Bridgelux assembly drawing 15-000718, 15-000719, and 15-000720 for complete product configuration.

Table 5: Module Dimensions & Connector Wiring

Parameter	BXEB-TL-L0280Z-27xxS1000-B-C3	BXEB-TL-L0560Z-27xxS2000-B-C3	BXEB-TL-L1120Z-27xxS4000-B-C3
Linear length	280.0 mm	560.0 mm	1120.0 mm
Linear width	24 mm		
Overall thickness	5.6 mm		
PCB thickness	1.6 mm		
Input wire cross-section	18-24 AWG		
Wire strip length	7-9 mm		

# Color Binning Information

**Figure 22: 3 SDCM Color Bins in CIE 1931 xy Color Space**



**Table 6: Bin Coordinates and Associated Typical CCT**

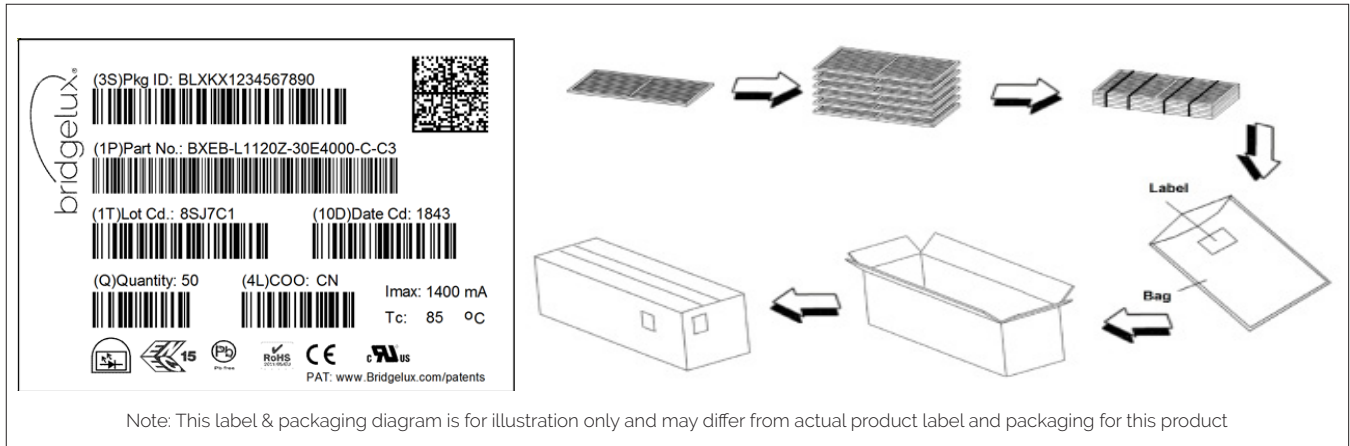
CCT	Color Consistency	CIE Center Point (x, y)	Corresponding CCT Range
2700K	3 SDCM	(0.458, 0.410)	2651K - 2794K
5000K	3 SDCM	(0.3445, 0.355)	4835K - 5215K
6500K	3 SDCM	(0.312, 0.328)	6250K - 6745K

Notes for Table 6

1. Color binning at solder point temperature  $T_{sp}$  of SMDs at 85°C.
2. Bridgelux maintains a tolerance of  $\pm 0.007$  on x and y color coordinates in the CIE 1931 color space.
3. Quadrangular ANSI bins shown for reference only

# Packaging and Labeling

**Figure 23: Vesta Series Packaging and Labeling**



**Table 7: Packaging Structure**

Box Parameter	L0280 modules	L0560 modules	L1120 modules
Quantity	200	100	100
Dimension	34.6 cm x 29.6 cm x 16.9 cm	60.0 cm x 19.4 cm x 16.9 cm	115.9 cm x 19.4 cm x 16.9 cm

## Product Labeling

Bridgelux Vesta Series modules contain a label on the front to help with product identification. In addition to the product identification markings, Bridgelux Vesta Series modules also contain markings for internal Bridgelux manufacturing use only. The image below shows which markings are for customer use and which ones are for Bridgelux internal use only. The Bridgelux internal manufacturing markings are subject to change without notice, however these will not impact the form, function or performance of the module.



Vesta Series Gen3  
280mm 1000lm 300mA

Customer Use- 2D Barcode  
Scannable barcode provides  
product part number and other  
Bridgelux internal production  
information.

# Design Resources

## Application Notes

Bridgelux has developed a comprehensive set of application notes and design resources to assist customers in successfully designing with the Vesta Series product family. For a list of resources under development, visit [www.bridgelux.com](http://www.bridgelux.com).

## Optical Source Models

Optical source models and ray set files are available for all Bridgelux products. For a list of available formats, visit [www.bridgelux.com](http://www.bridgelux.com).

## 3D CAD Models

Three dimensional CAD models depicting the product outline of all Bridgelux Vesta Series modules are available in both IGES and STEP formats. Please contact your Bridgelux sales representative for assistance.

# Precautions

## CAUTION: CHEMICAL EXPOSURE HAZARD

Exposure to some chemicals commonly used in luminaire manufacturing and assembly can cause damage to the LED linear. Please consult Bridgelux Application Note for additional information.

## CAUTION: EYE SAFETY

Eye safety classification for the use of Bridgelux Vesta Series is in accordance with IEC/TR62778: Application of IEC 62471 for the assessment of blue light hazard to light sources and luminaires. Vesta Series linears are classified as Risk Group 1 when operated at or below the maximum drive current. Please use appropriate precautions. It is important that employees working with LEDs are trained to use them safely.

## CAUTION: RISK OF BURN

Do not touch the Vesta Series modules during operation. Allow the linear to cool for a sufficient period of time before handling. The Vesta Series modules may reach elevated temperatures such that could burn skin when touched.

## CAUTION

### CONTACT WITH LIGHT EMITTING SURFACE (LES)

Avoid any contact with the LES. Do not touch or apply stress to the module SMD LESs (yellow phosphor resin area). Contact may cause damage to the module.

Optics and reflectors must not be mounted in contact with the LES (yellow phosphor resin area).

Optical devices may be mounted on the top surface of the module. Use the mechanical features of the module housing, edges and/or mounting holes to locate and secure optical devices as needed.

# Disclaimers

## STANDARD TEST CONDITIONS

Unless otherwise stated, module testing is performed at the nominal drive current.

## MINOR PRODUCT CHANGE POLICY

The rigorous qualification testing on products offered by Bridgelux provides performance assurance. Slight cosmetic changes that do not affect form, fit, or function may occur as Bridgelux continues product optimization.



# About Bridgelux: Bridging Light and Life™

At Bridgelux, we help companies, industries and people experience the power and possibility of light. Since 2002, we've designed LED solutions that are high performing, energy efficient, cost effective and easy to integrate. Our focus is on light's impact on human behavior, delivering products that create better environments, experiences and returns—both experiential and financial. And our patented technology drives new platforms for commercial and industrial luminaires.

**For more information about the company, please visit**

**[bridgelux.com](http://bridgelux.com)**

**[twitter.com/Bridgelux](https://twitter.com/Bridgelux)**

**[facebook.com/Bridgelux](https://facebook.com/Bridgelux)**

**[youtube.com/user/Bridgelux](https://youtube.com/user/Bridgelux)**

**[linkedin.com/company/Bridgelux](https://linkedin.com/company/Bridgelux)**

**WeChat ID: BridgeluxInChina**



46430 Fremont Blvd  
Fremont, CA 94538 USA  
Tel (925) 583-8400  
Fax (925) 583-8401  
**[www.bridgelux.com](http://www.bridgelux.com)**

© 2020 Bridgelux, Inc. All rights reserved. Product specifications are subject to change without notice. Bridgelux, the Bridgelux stylized logo design, Thrive, and Vesta are registered trademarks of Bridgelux, Inc. EB Series and Bridging Light and Life are trademarks of Bridgelux, Inc. All other trademarks are the property of their respective owners.

**Bridgelux Vesta TL Gen3 Thrive 1R Data Sheet DS137 Rev. A (08/2020)**