



SPECIFICATION SHEET

SPECIFICATION SHEET NO.	N1004- DFN10061OCSMOC
DATE	Oct. 04, 2021
REVISION	A0
DESCRIPTION	<p>SMD Plastic-Encapsulate ESD Protection Diodes, DFN1006 series ESD1201OC Type, Low Capacitance ESD Protection Diodes Reverse Working Voltage: 12V, Clamping Voltage 19V Max. Operating Temp. Range -55°C ~+125°C, Package in Tape/Reel, 10,000pcs/Reel RoHS/RoHS III compliant</p>
CUSTOMER	
CUSTOMER PART NUMBER	
CROSS REF. PART NUMBER	
ORIGINAL PART NUMBER	MDD ESD1201OC
PART CODE	DFN10061OCSMOC

VENDOR APPROVE			
Issued/Checked/Approved			
DATE: Oct. 04, 2021			

CUSTOMER APPROVE	
DATE:	

SMD ESD PROTECTION DIODES DFN1006 SERIES

MAIN FEATURE

- Low capacitance 15pF Max.
- Protects I/O port
- Response Time is < 1ns
- Meets MSL 1 requirements
- Low clamping voltage
- Low leakage current
- Stand-off voltage: 12V
- Peak power dissipation: 150W (8/20µs)
- Replacement for MLV (0402)



APPLICATION

- Cell phone handsets and accessories
- Serial and parallel ports
- Projection TV
- Portable Instrumentation
- Peripherals
- MP3 players

PART CODE GUIDE

RFQ

[Request For Quotation](#)

DFN1006	1OC	S	MOC
1	2	3	4

- 1) **DFN1006**: SMD Plastic-Encapsulate ESD Protection Diodes, DFN1006 series, 2 pads
- 2) **1OC**: Type code for original part number ESD1201OC
- 3) **S**: Package code, Package in Tape/Reel, 10000pcs/Reel
- 4) **MOC**: Marking code “MOC” on the case surface, Different Marking for different specification.

SMD ESD PROTECTION DIODES DFN1006 SERIES

DIMENSION (Unit: mm)

Image for reference



Marking: MOC

DFN1006

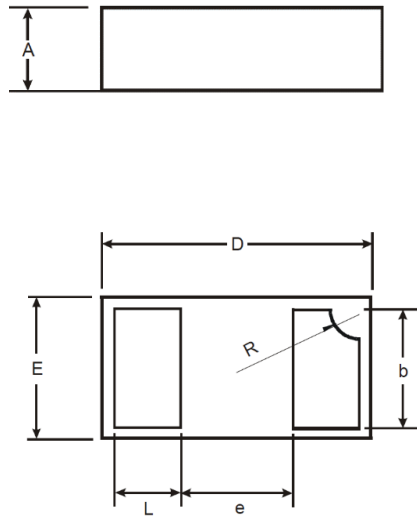

Symbol	Value (mm)		
	Min.	Typ.	Max.
A	0.45	0.50	0.550
b	0.45	0.50	0.55
D	0.95	1.00	1.05
E	0.55	0.60	0.650
e	-	0.40	-
L	0.20	0.25	0.30
R	0.07	0.12	0.17

Recommend Pad Layout

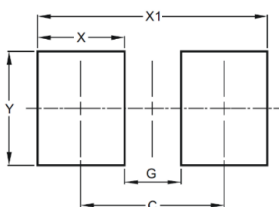

Circuit Diagram

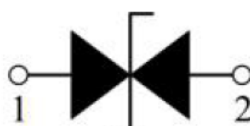

Symbol	Unit (mm)
C	0.90
G	0.40
X	0.50
X1	1.10
Y	0.50

SMD ESD PROTECTION DIODES DFN1006 SERIES

MECHANICAL DATA

Case	Terminals	Flammability Rating	Mounting Position	Weight per piece
JEDEC DFN1006 molded plastic body	-	UL 94V-0	-	-

ABSOLUTE MAX. RATINGS AT Ta=25 °C (unless otherwise specified)

Parameter	SYMBOLS	VALUE	UNITS
		LIMIT	
ESD per IEC 61000-4-2 (Air)	V ESD	+/-25	KV
ESD per IEC 61000-4-2 (Contact)	V ESD	+/-20	KV
Peak Pulse Power(tp=8/20us waveform)	P PP	150	W
Lead Solder Temperature – Maximum (10 Second Duration)	T L	260 (10 sec.)	°C
Operating Temperature Range	T OPT	-55 ~+ 125	°C
Storage Temperature Range	T STG	-55 ~ +150	°C

Note: The above data are for reference only.

SMD ESD PROTECTION DIODES DFN1006 SERIES

ELECTRICAL CHARACTERISTICS (Ta=25 °C unless otherwise specified)

Parameter	SYMBOLS	VALUE			UNITS
		Min.	Typical	Max.	
Reverse Working Voltage	V _{RWM}			12.0	V
Reverse Breakdown Voltage @ I _T = 1.0mA	V _{BR}	13.3			V
Reverse Leakage Current @V _{RWM} = 12V	I _R			0.2	μA
Clamping Voltage @ I _{PP} = 1A, t _p = 8/20μs	V _C			19	V
Clamping Voltage @ I _{PP} = 5A, t _p = 8/20μs	V _C			26	V
Junction Capacitance V _R = 0V, f = 1MHz	C _J		13	15	pF

SMD ESD PROTECTION DIODES DFN1006 SERIES
RELIABILITY

Number	Experiment Items	Experiment Method And Conditions	Reference Documents
1	Solder Resistance Test	Test 260°C± 5°C for 10 ± 2 sec. Immerse body into solder 1/16" ± 1/32"	MIL-STD-750D METHOD-2031.2
2	Solderability Test	230°C ±5°C for 5 sec.	MIL-STD-750D METHOD-2026.1 0
3	Pull Test	1 kg in axial lead direction for 10 sec.	MIL-STD-750D METHOD-2036.4
4	Bend Test	0.5Kg Weight Applied To Each Lead, Bending Arcs 90 °C ± 5 °C For 3 Times	MIL-STD-750D METHOD-2036.4
5	High Temperature Reverse Bias Test	TA=100°C for 1000 Hours at VR=80% Rated VR	MIL-STD-750D METHOD-1038.4
6	Forward Operation Life Test	TA=25°C Rated Average Rectified Current	MIL-STD-750D METHOD-1027.3
7	Intermittent Operation Life Test	On state: 5 min with rated IRMS Power Off state: 5 min with Cool Forced Air. On and off for 1000 cycles.	MIL-STD-750D METHOD-1036.3
8	Pressure Cooker Test	15 PSIG, TA=121°C, 4 hours	MIL-S-19500 APPENOIXC
9	Temperature Cycling Test	-55°C~+125°C; 30 Minutes For Dwelled Time 5 minutes for transferred time. Total: 10 cycles.	MIL-STD-750D METHOD-1051.7
10	Thermal Shock Test	0°C for 5 minutes., 100°C for 5minutes, Total: 10 cycles	MIL-STD-750D METHOD-1056.7
11	Forward Surge Test	8.3ms Single Sale Sine-wave One Surge.	MIL-STD-750D METHOD-4066.4
12	Humidity Test	TA=65°C, RH=98% for 1000 hours.	MIL-STD-750D METHOD-1021.3
13	High Temperature Storage life Test	150°C for 1000 Hours	MIL-STD-750D METHOD-1031.5

SMD ESD PROTECTION DIODES DFN1006 SERIES

SUGGESTED REFLOW PROFILE (For Reference Only)

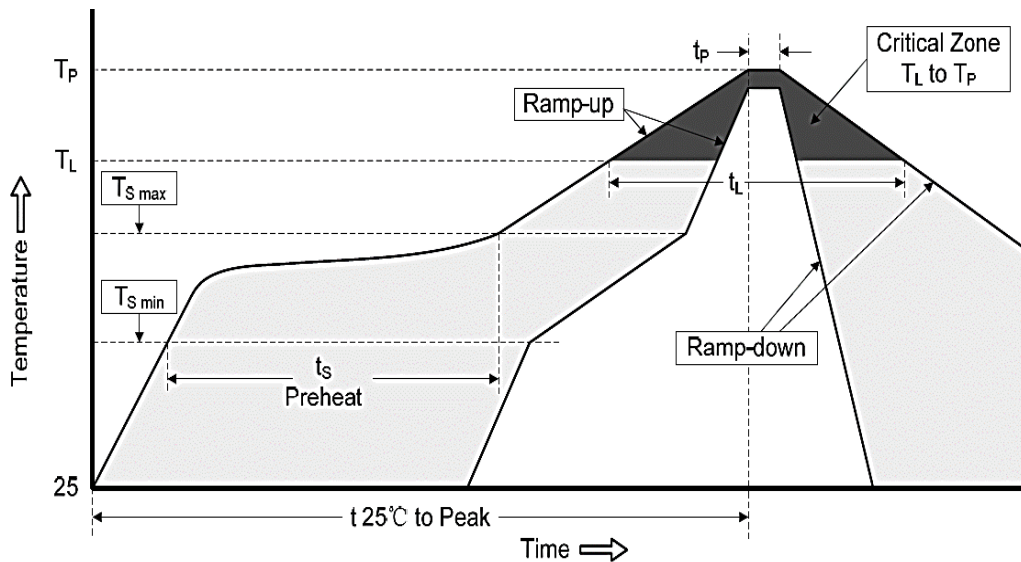

Profile Feature		Pb-Free Assembly
Average Ramp-up Rate (Ts Max to Tp)		3°C/second Max
Preheat	Temperature Min (Ts Min.)	150°C
	Temperature Max (Ts Max.)	200°C
	Time (ts Min. to ts Max.)	60 ~ 180 seconds
Time maintained above	Temperature (Tl)	217°C
	Time (tl)	60 ~ 150 seconds
Peak/Classification Temperature (Tp)		260 °C
Time within 5°C of actual Peak Temperature (tp)		20 ~ 40 seconds
Ramp-down rate		6 °C /Second Max.
Time 25 °C to Peak Temperature		8 minutes Max.
Suggest reflow times		3 Times Max.

SMD ESD PROTECTION DIODES DFN1006 SERIES

RATINGS AND CHARACTERISTIC CURVES (For Reference Only)

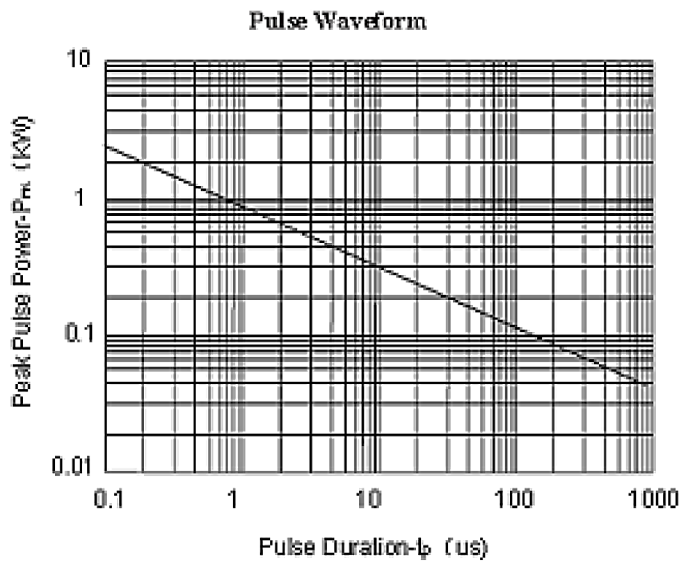
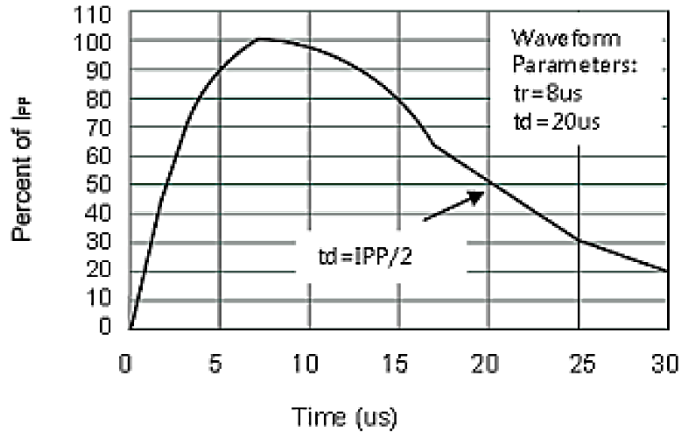

Non- Repetitive Peak Pulse Power vs. Pulse Time

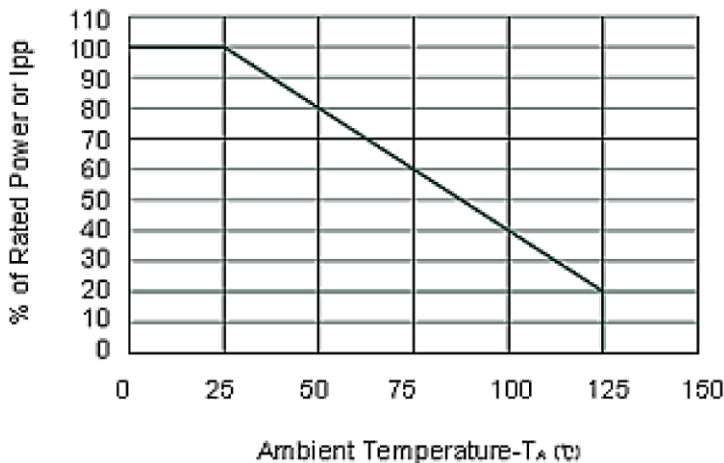

SMD ESD PROTECTION DIODES DFN1006 SERIES

TAPE/REEL (Unit: mm)

All Devices are packed in accordance with EIA standard RS-481-A and specifications.

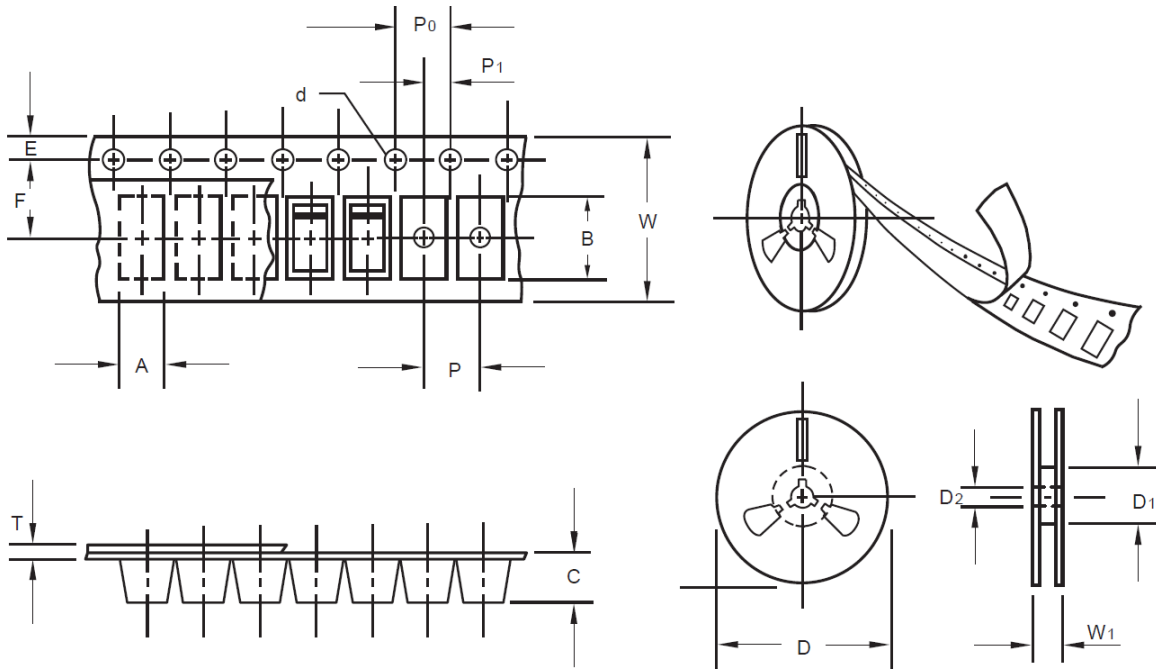

Item	Symbol	Tolerance	DFN1006
Carrier width	A	0.1	2.10
Carrier Length	B	0.1	4.00
Carrier Depth	C	0.1	1.60
Sprocket hole	d	0.05	1.55
13" Reel outside diameter	-	-	-
13" Reel inner diameter	-	-	-
7" Reel outside diameter	D	2.0	178.00
7" Reel inner diameter	D1	Min.	50.00
Feed hole diameter	D2	0.5	13.00
Sprocket hole position	E	0.1	1.75
Punch hole position	F	0.1	3.50
Punch hole pitch	P	0.1	4.00
Sprocket hole pitch	P0	0.1	4.00
Embossment center	P1	0.1	2.00
Overall tape thickness	T	0.1	0.25
Tape width	W	0.3	8.15
Reel width	W1	1.0	10.50

SMD ESD PROTECTION DIODES DFN1006 SERIES

SPQ PACKAGE for Reference

Item	Unit	Value
Case Code		DFN1006
Reel Size	Inch	7
Reel Size	mm	178
Tape Space	mm	/
SPQ /Reel	pcs	10,000
Weigh /SPQ	LBS	
Weigh /SPQ	KGs	
Qty. Per Box	pcs	20,000
Inner Box	Inch	L8.0*W8.0*H1.5

DISCLAIMER

NextGen Component, Inc. reserves the right to make changes to the product(s) and or information contained herein without notice. No liability is assumed as a result of their use or application. No rights under any patent accompany the sale of any such product(s) or information