

Features

- ◆ Ideal for printed circuit boards
- ◆ Applicable for automotive insertion
- ◆ High surge current capability
- ◆ Solder Dip 260 °C, 40 seconds

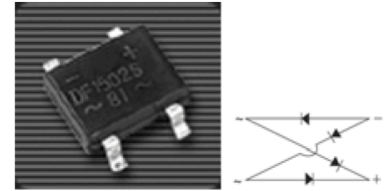

DFS

Mechanical Data

- ◆ Case: DFS
Epoxy meets UL-94V-0 Flammability rating
- ◆ Terminals: Matte tin plated (E3 Suffix) leads, solderable per J-STD-002B and JESD22-B102D
- ◆ Polarity: As marked on body

Typical Applications

General purpose use in ac-to-dc bridge full wave rectification for SMPS, Lighting Ballaster, Adapter, Battery Charger, Home Appliances, Office Equipment, and Telecommunication applications

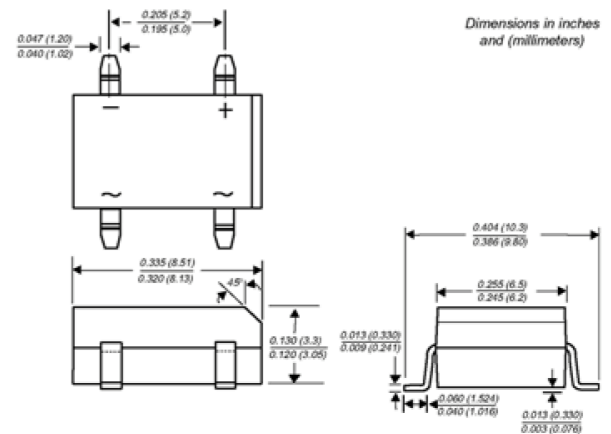

Maximum Ratings and Electrical Characteristics

($T_A=25^\circ\text{C}$ unless otherwise noted)

Parameter	Symbols	DF005S DBS101	DF01S DBS102	DF02S DBS103	DF04S DBS104	DF06S DBS105	DF08S DBS106	DF10S DBS107	Units
Maximum repetitive peak reverse voltage	V_{RRM}	50	100	200	400	600	800	1000	Volts
Maximum RMS voltage	V_{RMS}	35	70	140	280	420	560	700	Volts
Maximum DC blocking voltage	V_{DC}	50	100	200	400	600	800	1000	Volts
Maximum average forward output rectified current at $T_A=40^\circ\text{C}$ (Note 2)	$I_{F(AV)}$	1.0							Amp
Peak forward surge current single half sine-wave superimposed on rated load (JEDEC Method)	I_{FSM}	30.0							Amps
Rating for fusing ($t < 8.3\text{ms}$)	Pt	10							A^2sec
Maximum instantaneous forward voltage drop per leg at 0.5A	V_F	1.1							Volts
Maximum DC reverse current at rated DC blocking voltage per leg	I_R	5.0 500							μA
Typical junction capacitance per leg (Note 1)	C_J	25							pF
Typical thermal resistance per leg (Note 2)	$R_{\theta JA}$ $R_{\theta JL}$	40 15							$^\circ\text{C}/\text{W}$
Operating junction and storage temperature range	T_J, T_{STG}	-55 to +150							$^\circ\text{C}$

- Notes:**
1. Measured at 1.0 MHz and applied reverse voltage of 4.0 Volts
 2. Units mounted on P.C.B. with 0.51 x 0.51" (13 x 13mm) copper pads

RATINGS AND CHARACTERISTIC CURVES

($T_A = 25^\circ\text{C}$ unless otherwise noted)

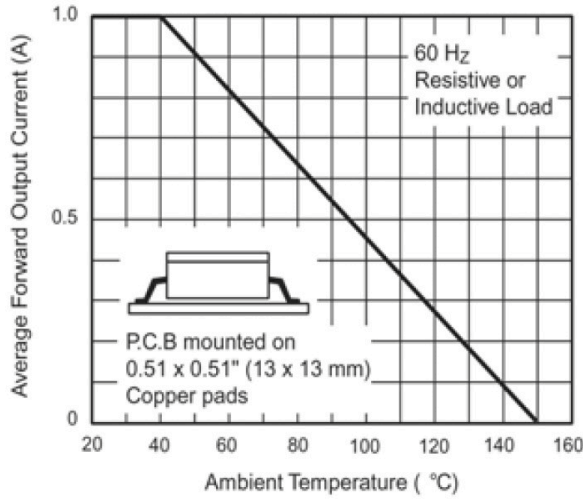

Figure 1. Derating Curve Output Rectified Current

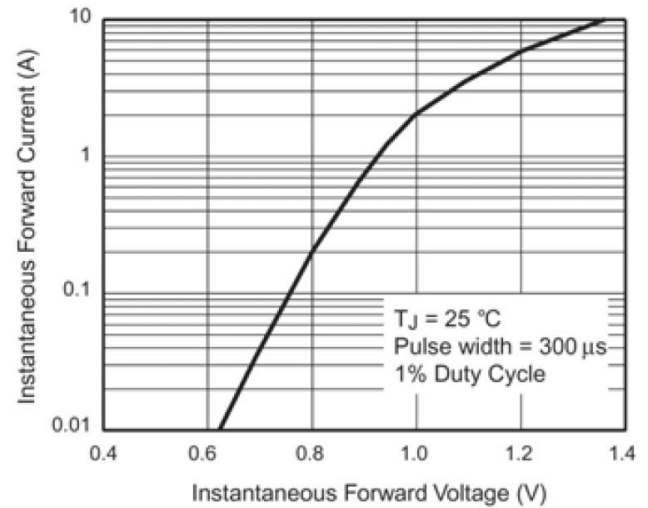

Figure 3. Typical Forward Characteristics Per Leg

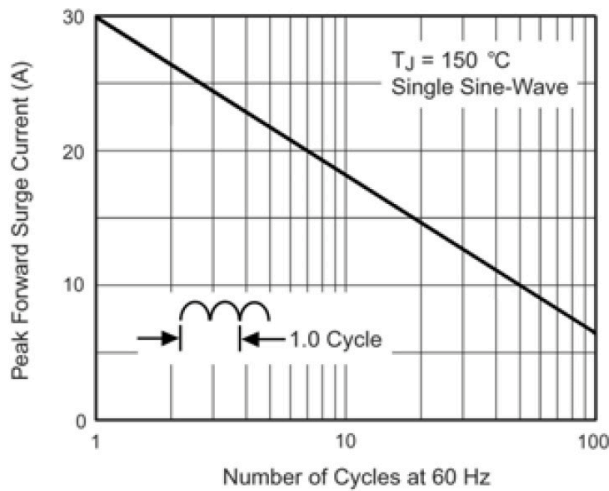

Figure 2. Maximum Non-Repetitive Peak Forward Surge Current Per Leg

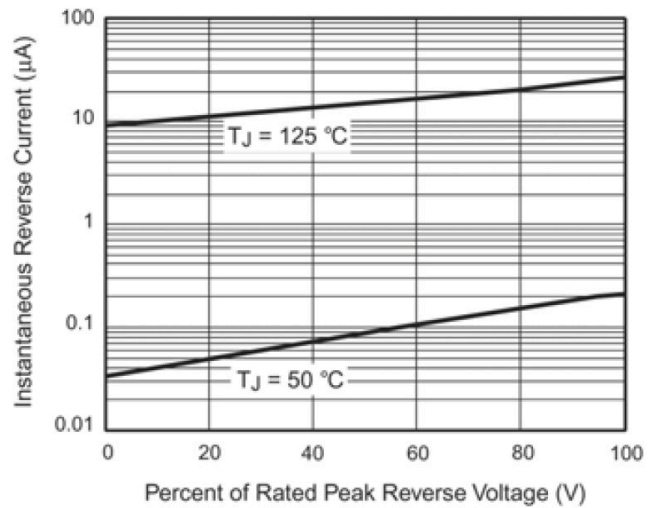

Figure 4. Typical Reverse Leakage Characteristics Per Leg

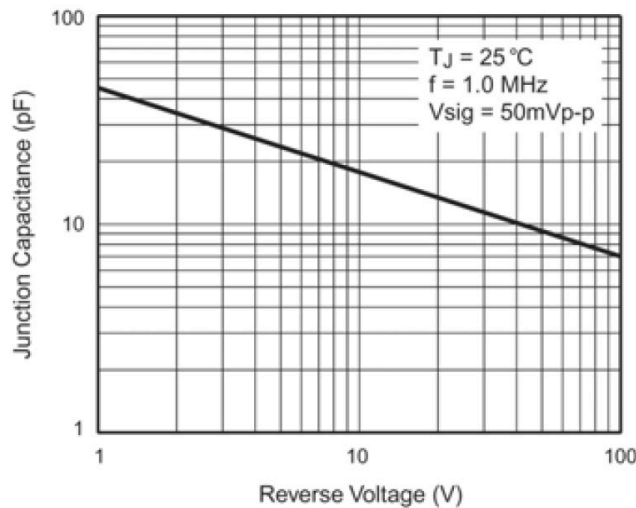

Figure 5. Typical Junction Capacitance Per Leg

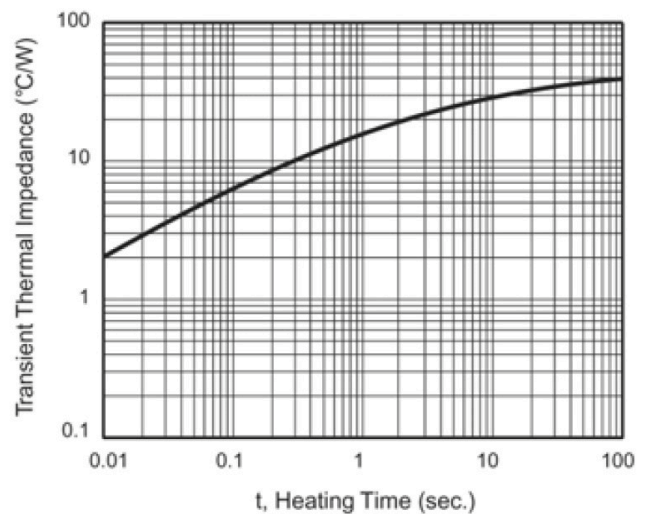

Figure 6. Typical Transient Thermal Impedance