



TAOGLAS®



Datasheet

6dBi 5.9GHz 12mm
DSRC/C-V2X Ceramic Patch Antenna

Part No:
DCP.5900.12.4.A.02

Features:

5.9GHz C-V2X Ceramic Patch Antenna

5850MHz to 5925MHz

Peak Gain: 5.89dBi

Efficiency: >75%

Dimensions: 12*12*4mm

Manufactured in an IATF16949 Approved Facility

RoHS Compliant

1. Introduction	3
2. Specifications	4
3. Antenna Characteristics	5
4. Radiation Patterns	7
5. Mechanical Drawing	10
6. Footprint	11
7. Antenna Integration Guide	12
8. Evaluation Board Mechanical Drawing	17
9. Packaging	19
10. Application Note	20
Changelog	21

Taoglas makes no warranties based on the accuracy or completeness of the contents of this document and reserves the right to make changes to specifications and product descriptions at any time without notice. Taoglas reserves all rights to this document and the information contained herein. Reproduction, use or disclosure to third parties without express permission is strictly prohibited.



1. Introduction



The DCP.5900 is a world-leading C-V2X (& DSRC) Antenna with up to 75% efficiency. It is a 12*12*4 mm embedded ceramic DSRC Patch antenna. It is a high performance compact 6dBi directional antenna designed to operate at 5850 MHz to 5925 MHz for C-V2X systems. It is mounted via pin and double-sided adhesive and has been tuned for a center position on a 70mm *70mm ground plane.

The polarization has been designed to be circularly polarized to enable a more stable system signal strength on moving vehicles. For further optimization to customer-specific device environments where positioning is off-center or a different ground-plane size, a custom-tuned patch antenna can be supplied, subject to NRE and MOQ.

C-V2X is the communications medium of choice for active safety V2V/V2X (Vehicle-to-Vehicle and Vehicle-to-Other) systems. Primarily allocated for vehicle safety applications, C-V2X supports high-speed, low-latency, short-range, V2V/V2X wireless communications.

For further optimization to customer-specific device environments and for support to integrate and test this antennas performance in your device, contact your regional Taoglas Customer Services Team

2. Specifications

Electrical	
5850-5925 (MHz)	
Peak Gain (dBi)	5.1
Average Gain (dB)	-2.6
Efficiency (%)	55.0
Impedance	50Ω
Polarization	RHCP
Mechanical	
Ceramic Dimension	12 x 12 x 4 mm
Pin Diameter	0.85 mm
Pin Length	2.4mm
Weight	2.1g
Environmental	
Temperature Range	-40°C to 105°C
Humidity	Non-condensing 65°C 95% RH

*All tests done on a 70mm x 70mm ground plane

3. Antenna Characteristics

3.1 Return Loss

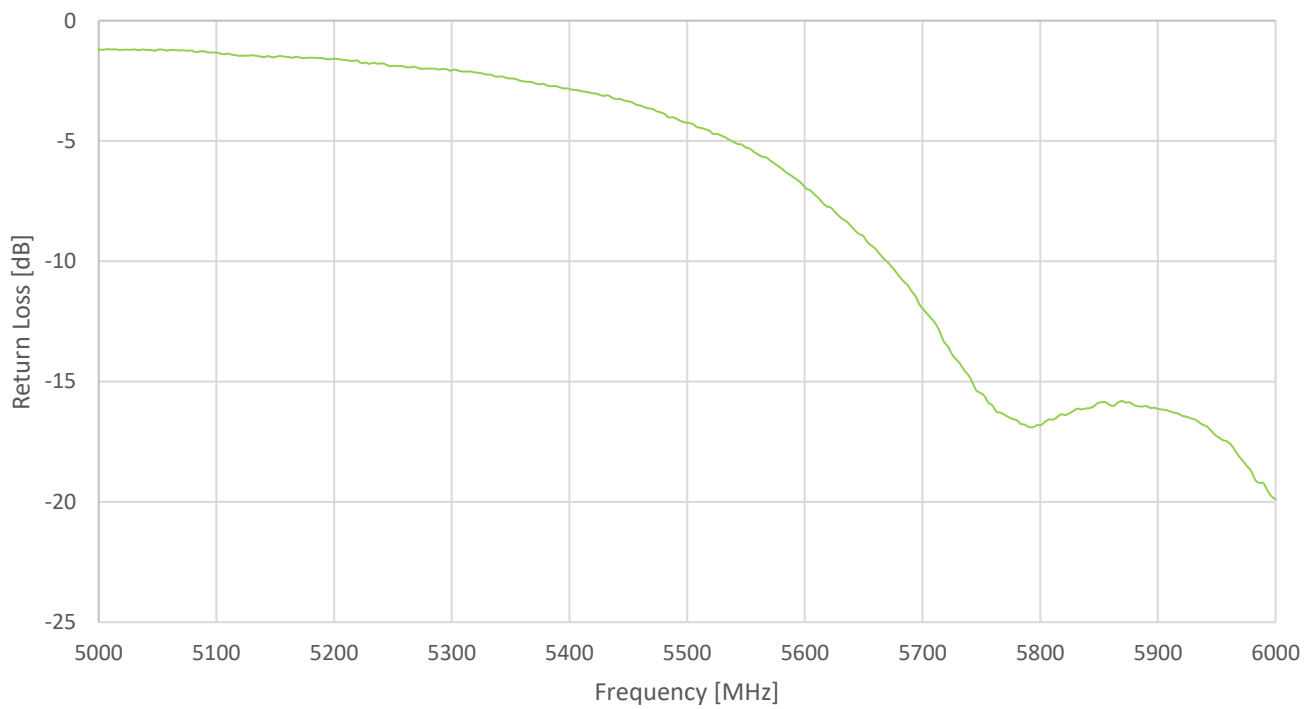

3.2 Efficiency

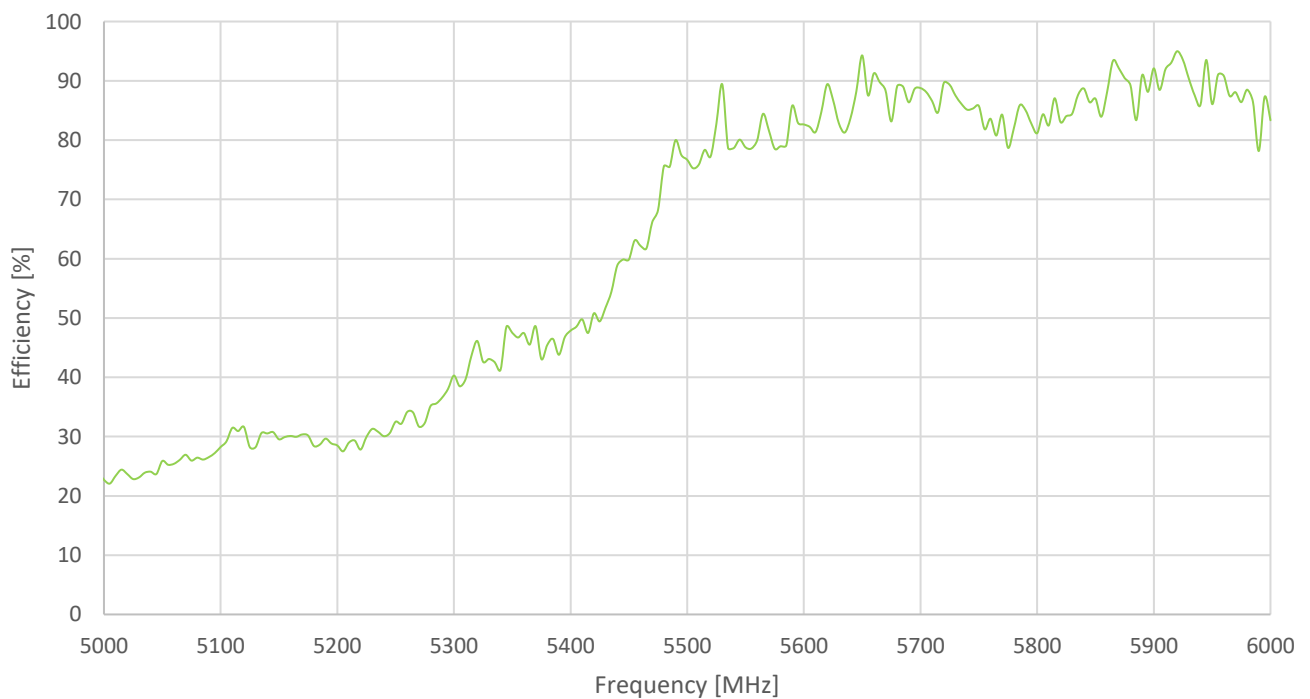

3.3 Average Gain

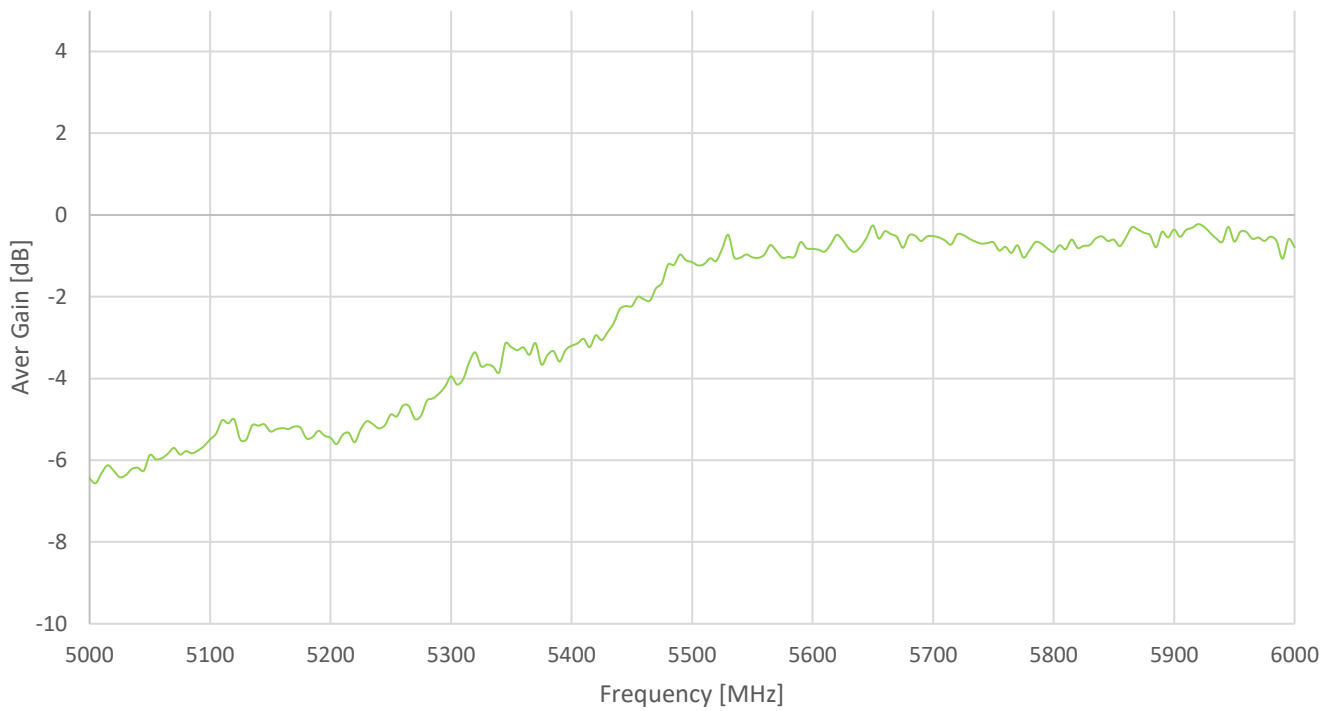

3.4 Peak Gain

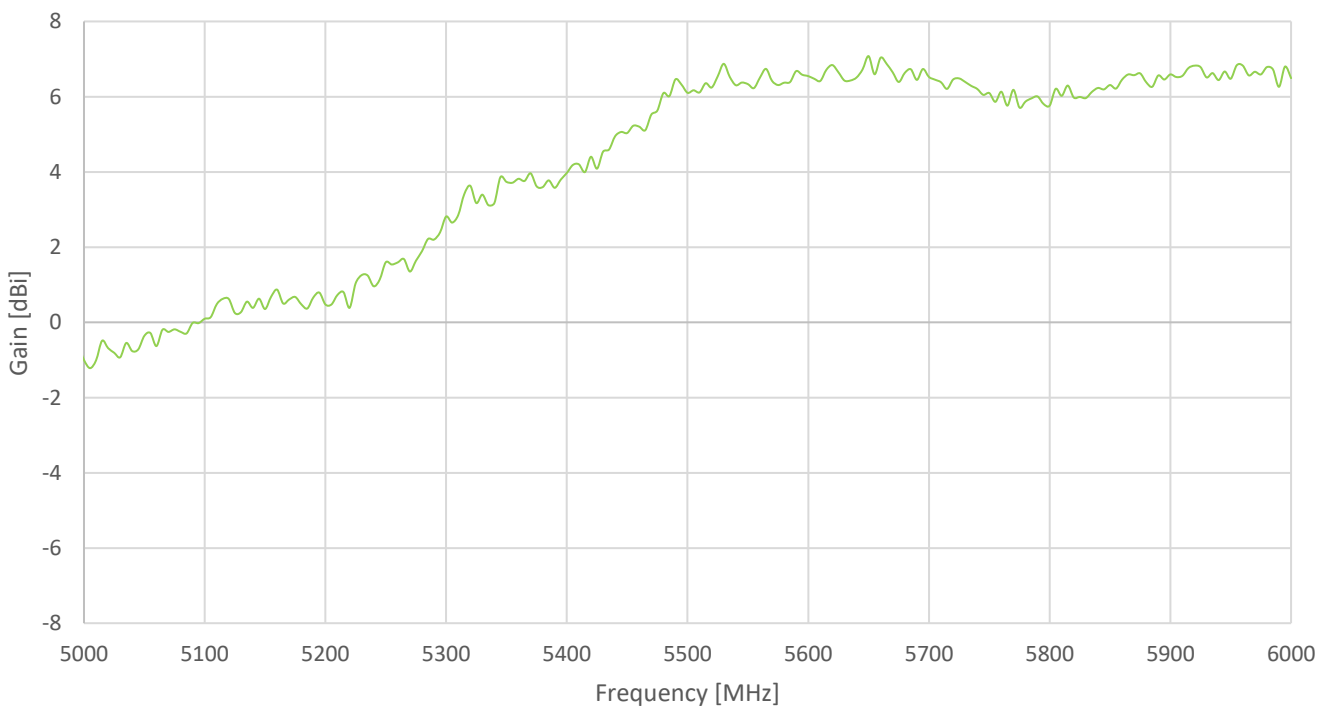

4. Radiation Patterns

4.1 Test Setup

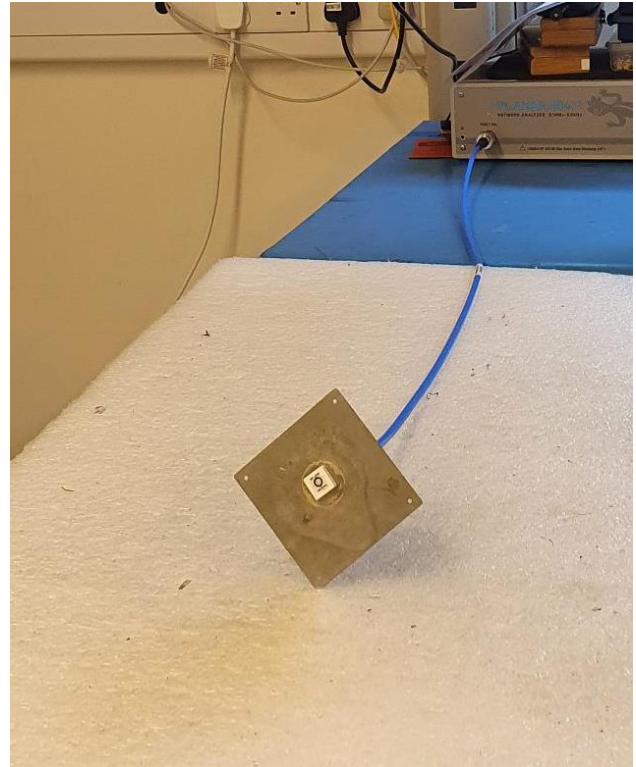
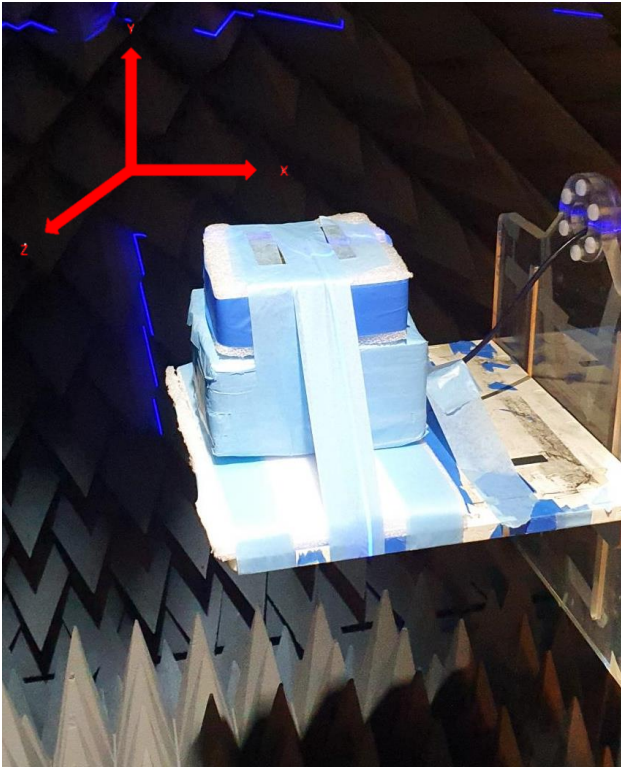

70mm x 70mm Ground Plane

4.2 5850MHz, 2D & 3D Radiation Patterns

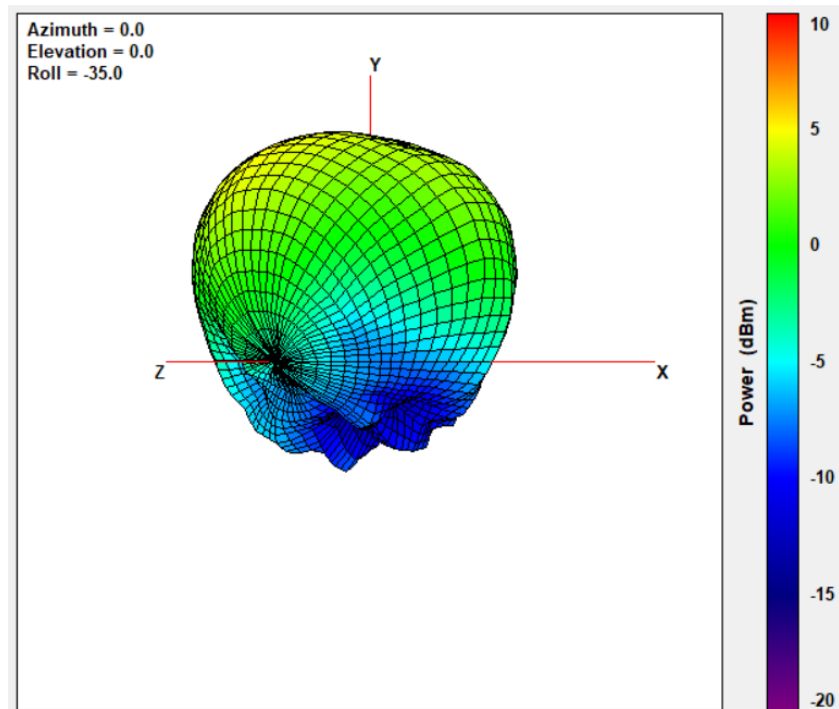

XY Plane

XZ Plane

YZ Plane

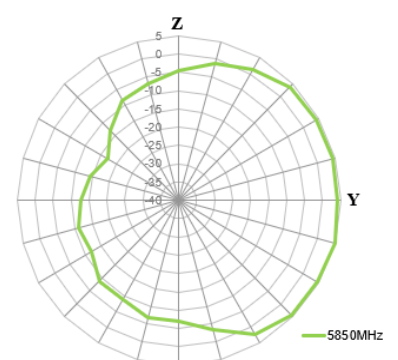
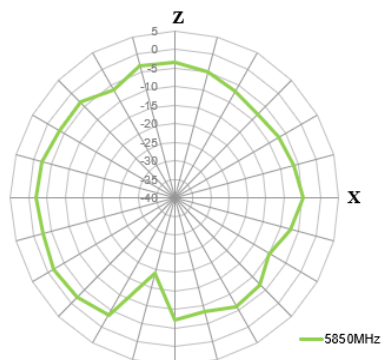
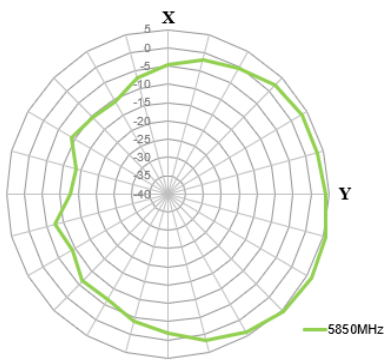

5925MHz

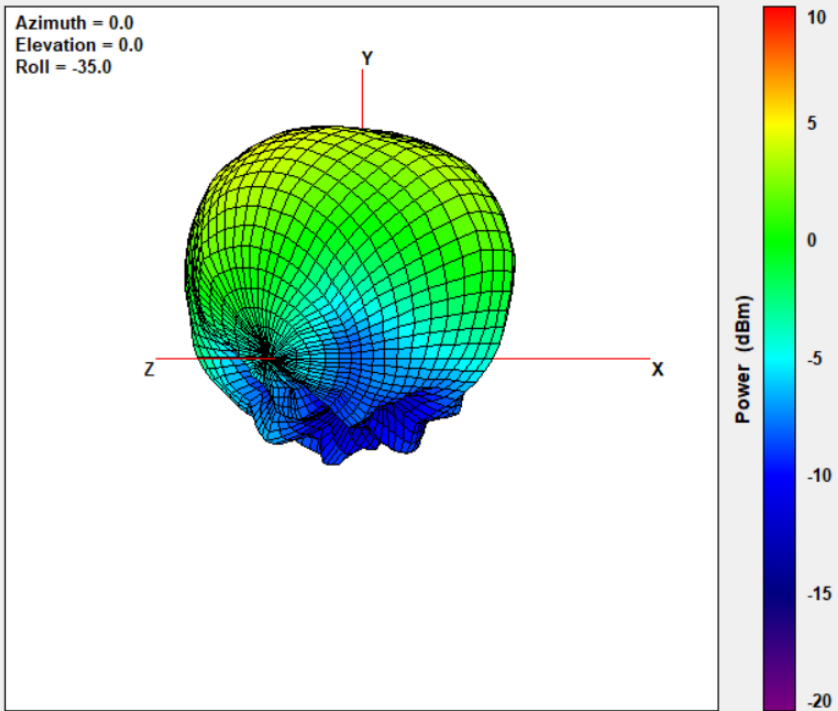

XY Plane

XZ Plane

YZ Plane

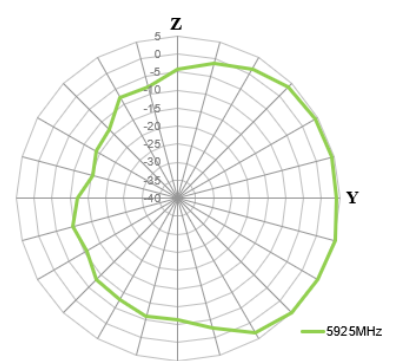
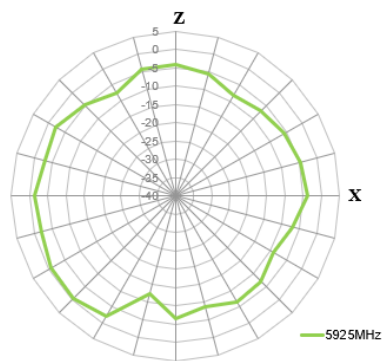
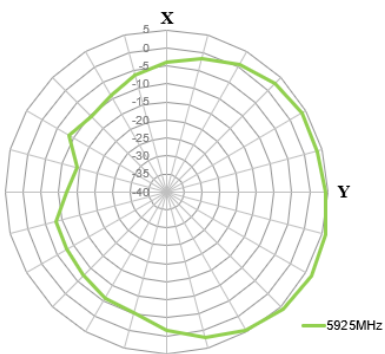

5. Mechanical Drawing (Units: mm)

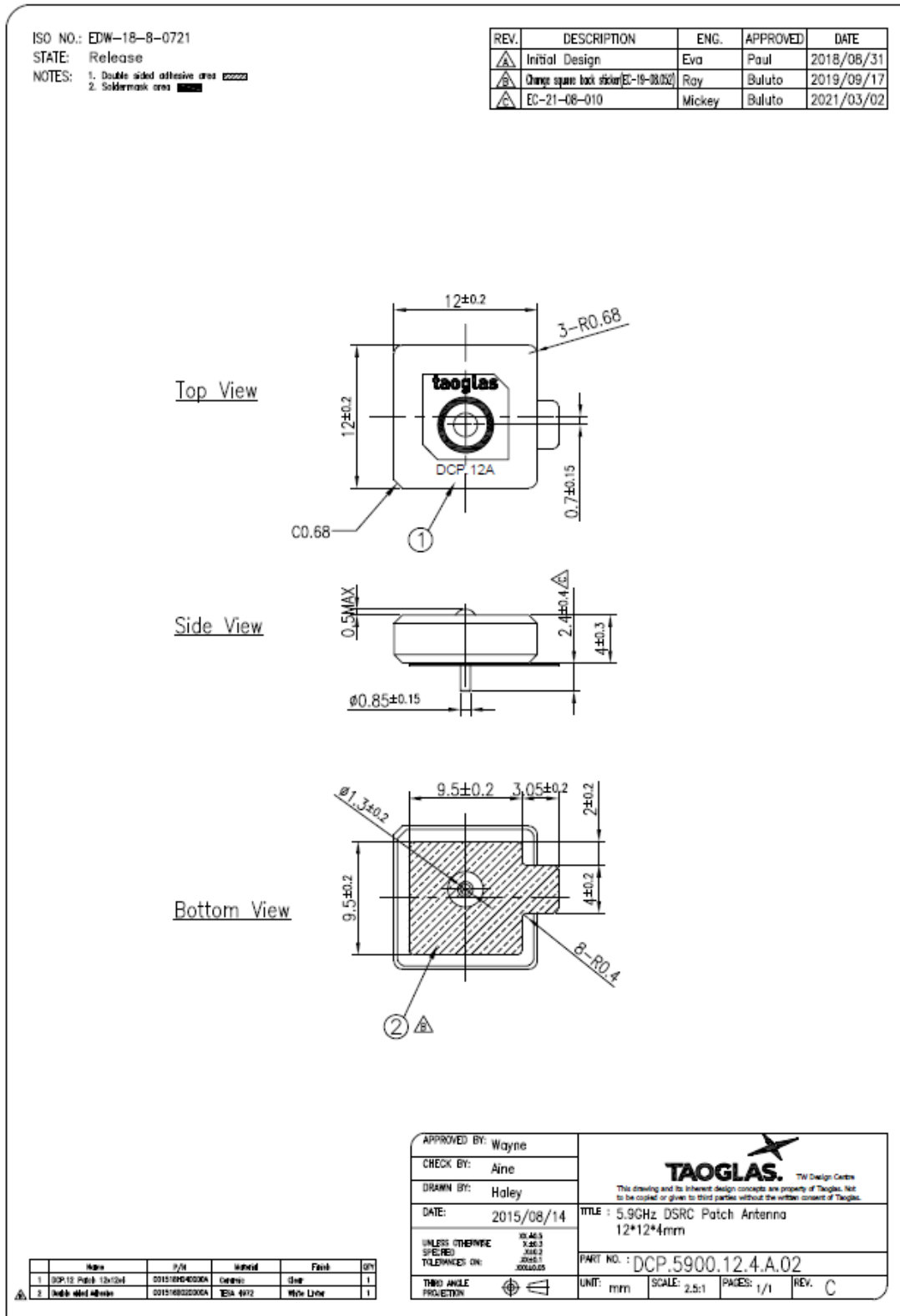

6. Footprint

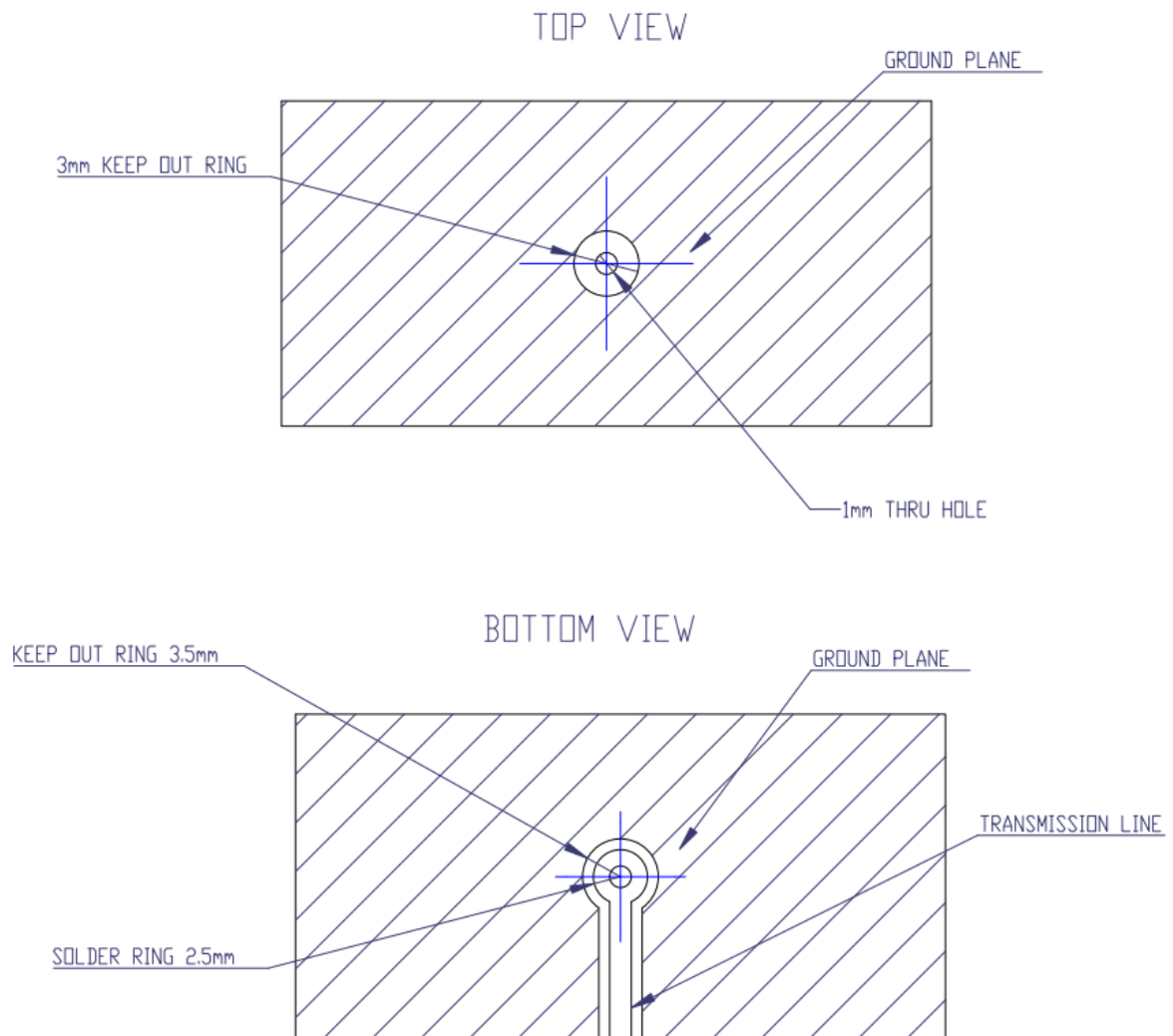

7. Antenna Integration Guide

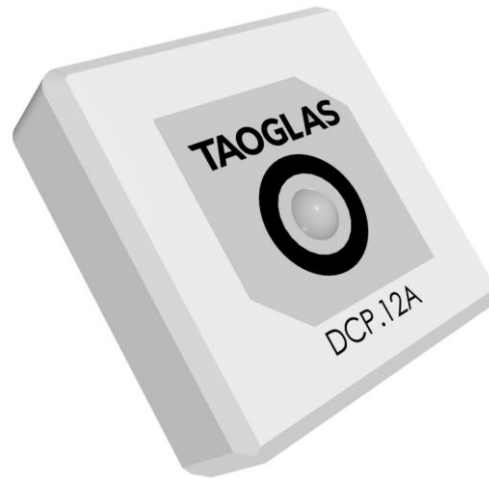

7.1 Schematic Symbol and Pin Definition

The circuit symbol for the antenna is shown below. The antenna has 1 pin as indicated below.

Pin	Description
1	RF Feed

DCP.5900.12.4.A.02
ANT1

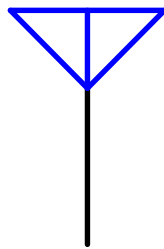

7.2 Antenna Integration

The antenna should be placed at the center of the ground plane with a length and width of 70mm. Maintaining a square symmetric ground plane shape and symmetric environment around the antenna is critical to maintaining the excellent axial ratio and phase center performance shown in this datasheet.



Top Side w/ Solder Mask

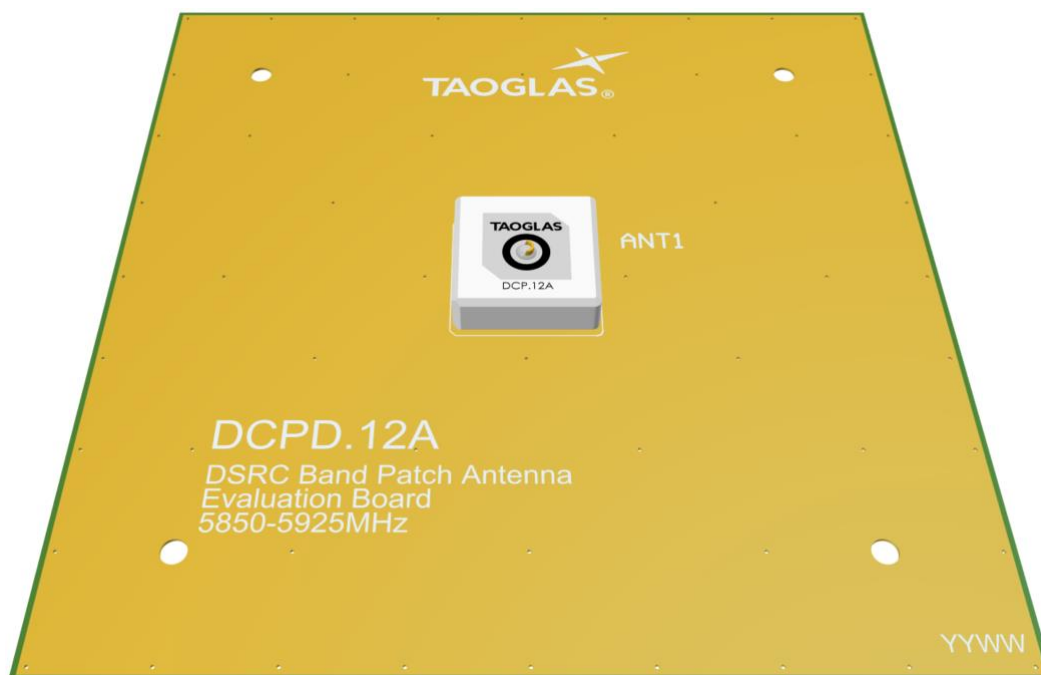

Top Side w/o Solder Mask

7.3 PCB Layout

The footprint and clearance on the PCB must comply with the antenna specification. The PCB layout shown in the diagram below demonstrates the antenna footprint.



Topside

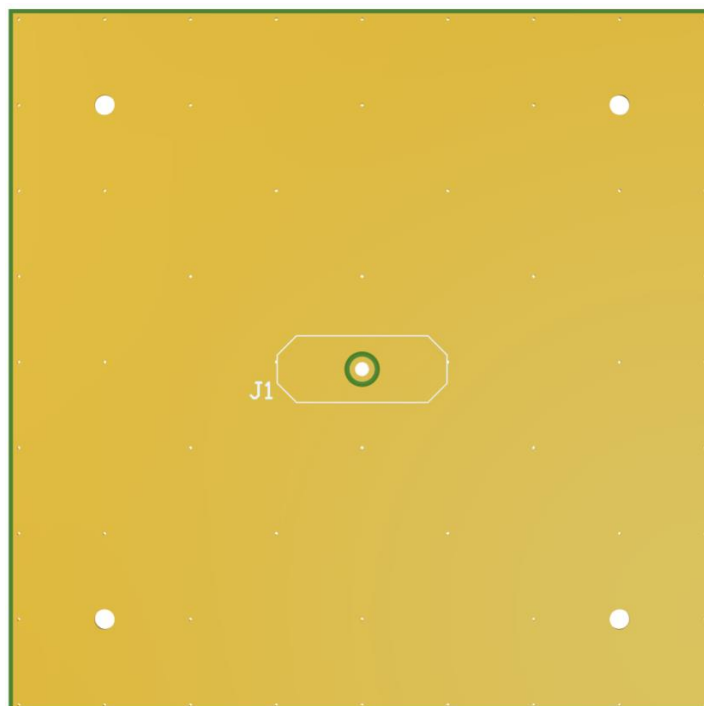

Bottom Side

7.4 Evaluation Board

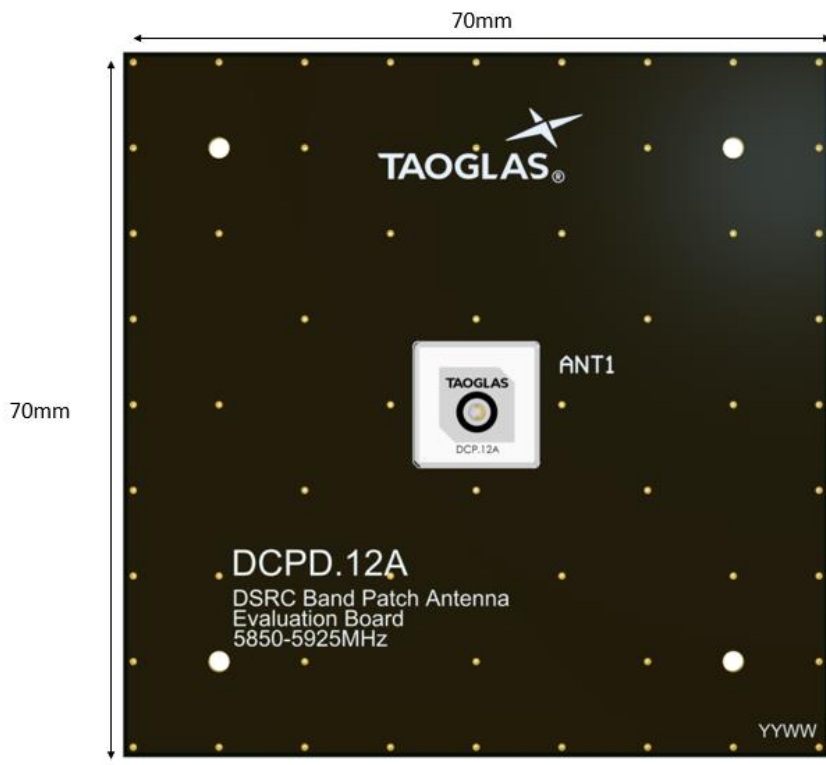

Topside

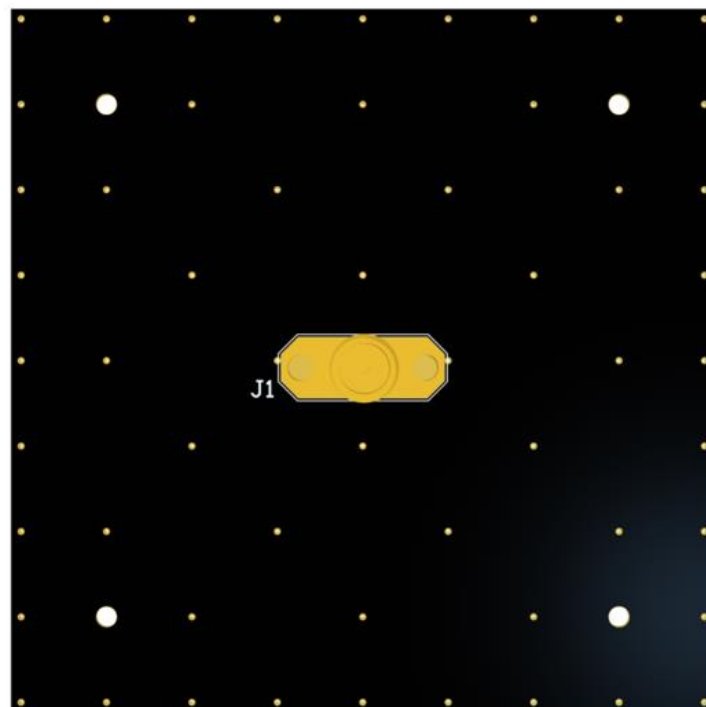

Bottom Side

8. Evaluation Board Mechanical Drawing (Unit: mm)

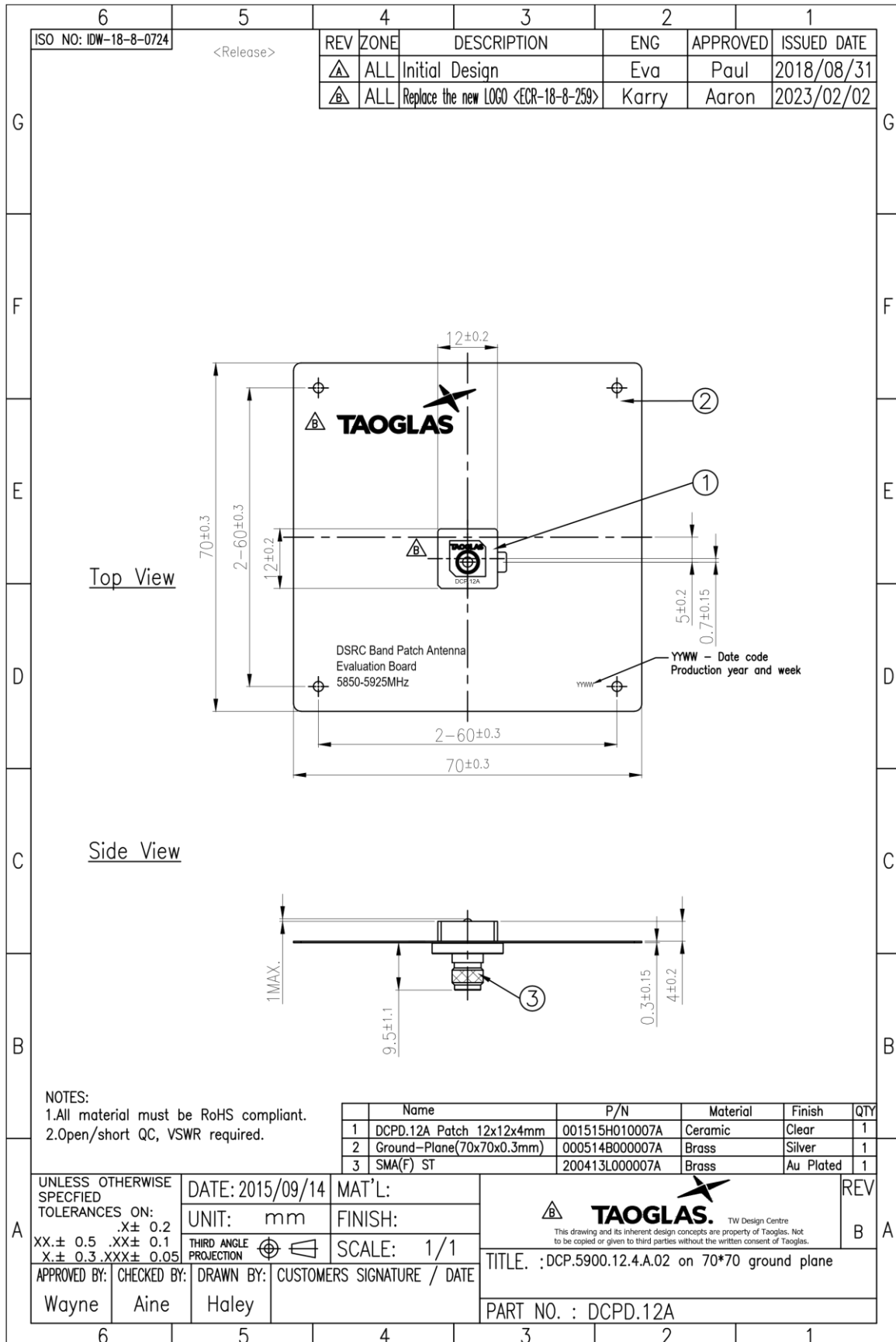

9. Packaging

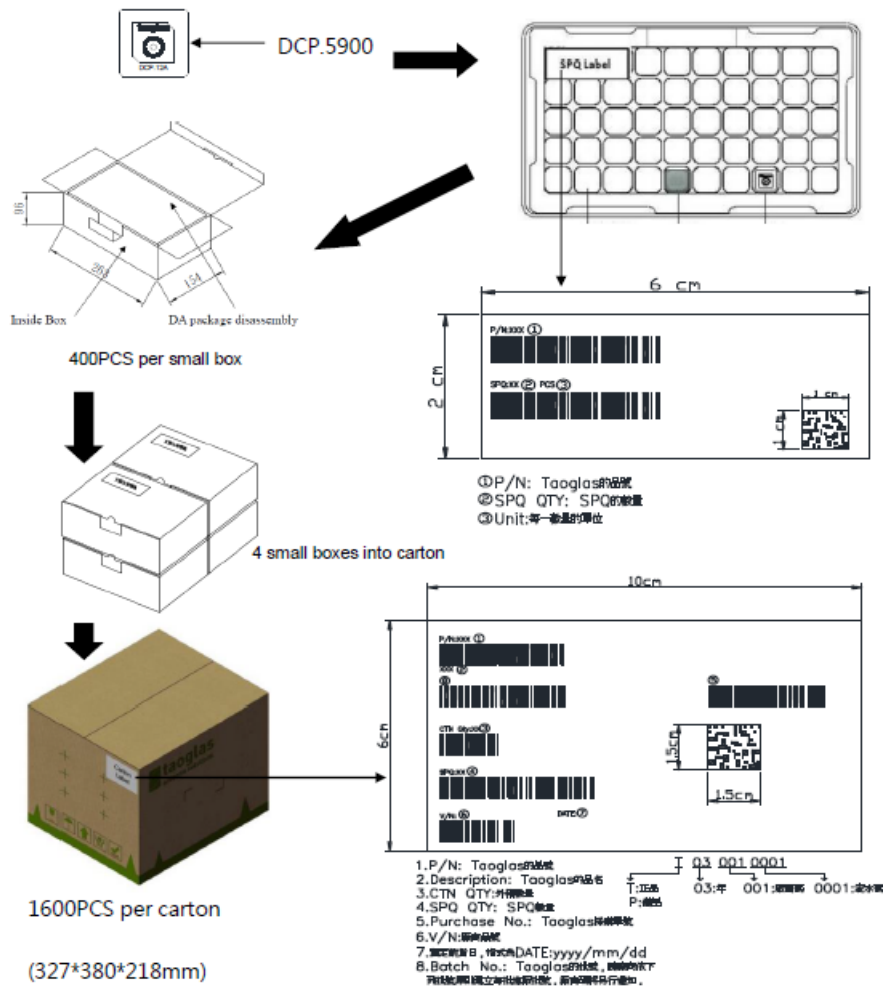

10. Application Note

The DCP.5900 C-V2X patch antenna is designed for 70mm*70mm ground plane center. Taoglas provides the experimental reference below if the antenna isn't placed at the center of ground plane. Please refer to the return loss data shown in the graph below.

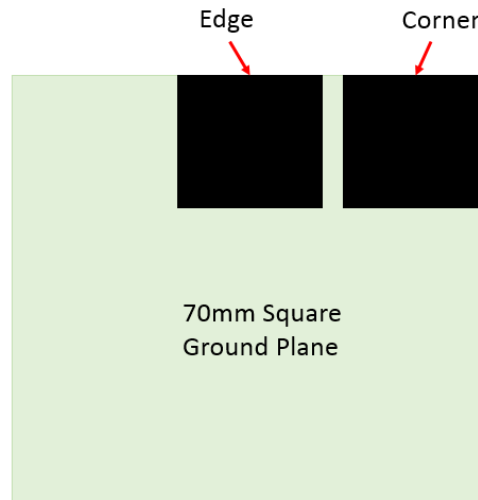

10.1 Return Loss (Varying Position on Ground Plane)

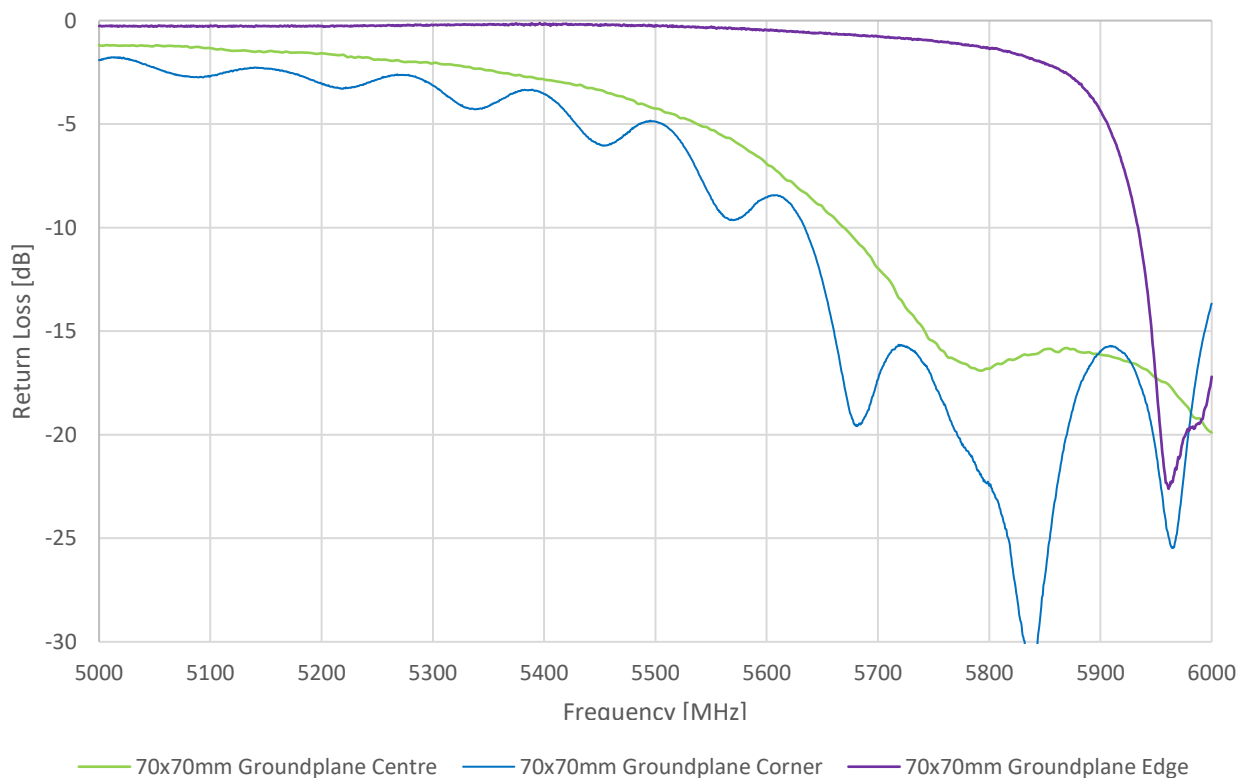

10.2 Return Loss (Varying Ground Plane Size)

Antenna performance on different ground plane sizes is shown below. (The antenna location is at the center of ground plane)

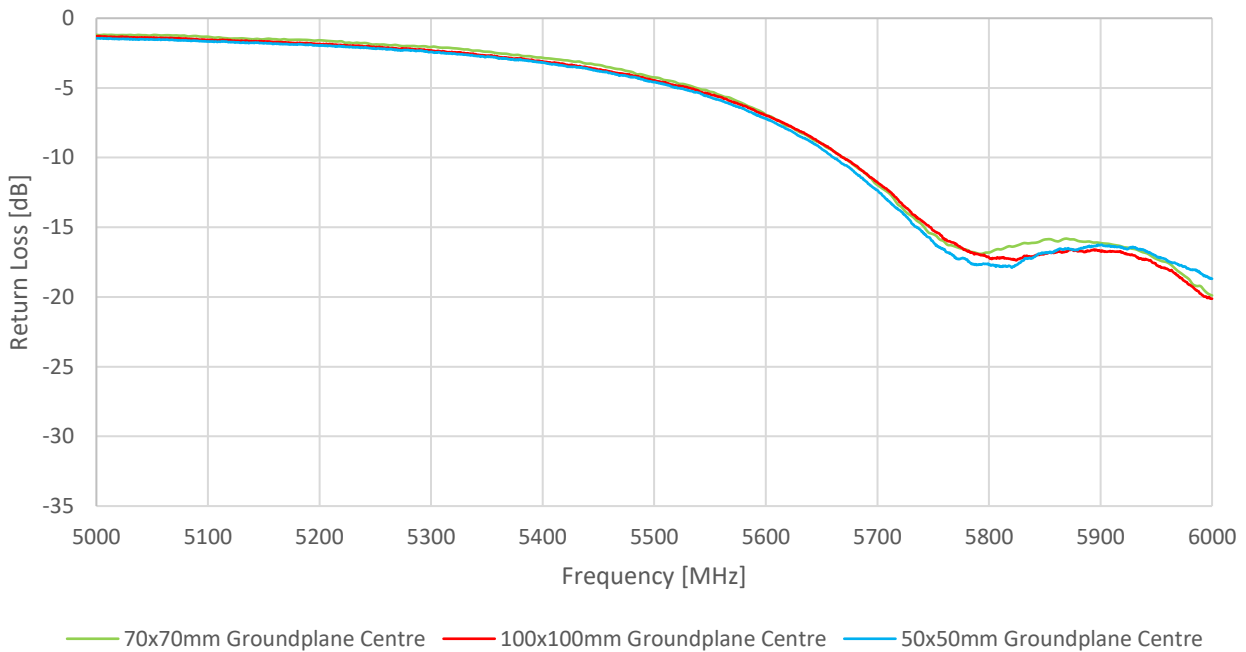

10.3 Efficiency

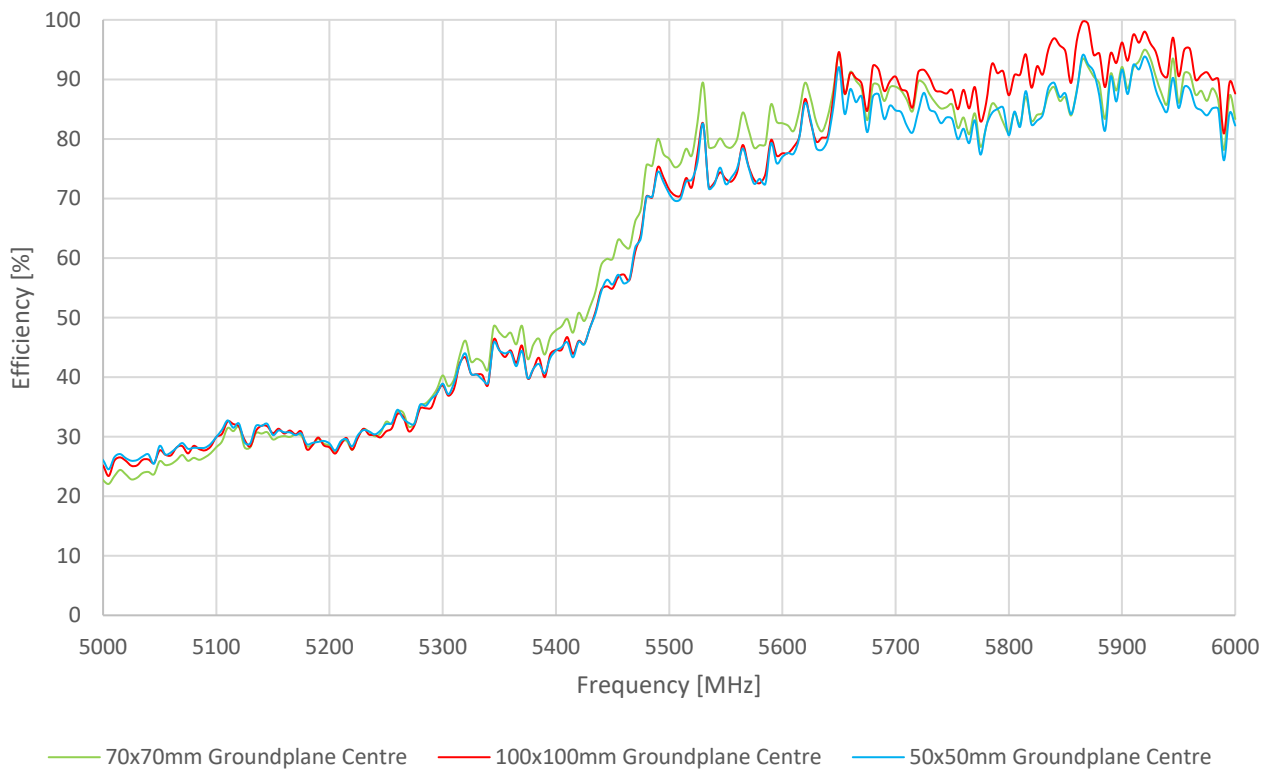

Changelog for the datasheet

SPE-15-8-071 – DCP.5900.12.4.A.02

Revision: F (Current Version)	
Date:	2023-02-28
Changes:	Antenna Integration Guide Added
Changes Made by:	Cesar Sousa

Previous Revisions

Revision: E	
Date:	2022-08-18
Changes:	Full Datasheet update
Changes Made by:	Evan Murphy

Revision: D (Current Version)	
Date:	2018-03-27
Changes:	Installation Guide Amended
Changes Made by:	Jack Conroy

Revision: C	
Date:	2017-03-08
Changes:	Packaging Details Updated
Changes Made by:	Made by Andy Mahoney

Revision: B	
Date:	2017-08-17
Changes:	Packaging Details Updated
Changes Made by:	Andy Mahoney

Revision: A (Original First Release)	
Date:	2017-08-10
Notes:	
Author:	Your Name Here



TAOGLAS®

www.taoglas.com

