

LTC3890-2

60V, Low I_Q Multiphase Synchronous Step-Down Converter

DESCRIPTION

Demonstration circuit 2236A-A is a high output voltage, high efficiency synchronous PolyPhase[®] buck converter featuring the LTC[®]3890EUH-2. The DC2236A-A has a wide input voltage range of 16V up to 60V, and is capable of delivering up to 25A of output current. The output voltage is set to 12V, however, the output voltage can go as high as 24V, with certain modifications. The DC2236A-A supports three operation modes: Fixed frequency modulation, pulse-skipping and Burst Mode[®] operation. Fixed frequency mode of operation maximizes the output current, reduces output voltage ripple, and yields a low noise switching spectrum. Burst Mode employs a variable frequency switching algorithm that minimizes the no-load input quiescent current and improves efficiency at light loads.

The DC2236A-A consumes less than 50 μ A of quiescent current during shutdown and less than 1mA under a no

load condition with the output in regulation in Burst Mode operation. The DC2236A-A has a standard operating frequency of 150kHz, but can be adjusted to frequencies as high as 900kHz. The DC2236A is a dual phase single output step-down converter; however it is designed to be easily transformed to a 4- or 6- phase system by combining two or three DC2236A-A boards. The LTC3890EUH-2 data sheet gives a complete description of these parts, operation and application information and must be read in conjunction with this quick start guide for demonstration circuit 2236A-A. Table 1 summarizes the differences between the parts in the LTC3890 family.

Design files for this circuit board are available at <http://www.linear.com/demo/DC2236A-A>

LT, LT, LTC, LTM, Linear Technology, Burst Mode, PolyPhase and the Linear logo are registered trademarks of Linear Technology Corporation. All other trademarks are the property of their respective owners.

PERFORMANCE SUMMARY

Specifications are at $T_A = 25^\circ\text{C}$

PARAMETER	CONDITIONS	VALUE
Minimum Input Voltage		16V
Maximum Input Voltage		60V
Output Voltage V_{OUT} Regulation	$V_{IN} = 16\text{V to } 55\text{V}$	$12\text{V} \pm 2\%$
Maximum Continuous Output Current		25A
Preset Operating Frequency	$R7 = 30.1\text{k}\Omega$	150kHz
External Clock Sync. Frequency Range		75kHz to 850kHz
Efficiency	$V_{IN} = 36\text{V}$, $V_{OUT} = 12\text{V}$, $I_{OUT} = 12\text{A}$, See Figure 3 Efficiency Curves for Complete Operating Range	97%
Typical Output Ripple V_{OUT}	$V_{IN} = 36\text{V}$, $I_{OUT} = 12\text{A}$ (20MHz BW)	<35mV _{p-p}
Quiescent Current at Shutdown	$V_{IN} = 16\text{V to } 55\text{V}$	<50 μ A
Input Current at No Load	$V_{IN} = 16\text{V to } 55\text{V}$	<1mA

QUICK START PROCEDURE

Demonstration circuit 2236A-A is easy to set up to evaluate the performance of the LTC3890-2. For proper measurement equipment configuration, set up the circuit according to the diagram in Figure 1. Before proceeding to test, insert shunt into JP1 (RUN) OFF position, which connects the RUN pin to ground (GND), and thus, shuts down the circuit.

NOTE: When measuring the input or output voltage ripple, care must be taken to avoid a long ground lead on the oscilloscope probe. Measure the input or output voltage ripple by touching the probe tip directly across the V_{IN} or V_{OUT} and GND terminals. See Figure 2 for proper scope probe technique.

1. With the DC2236A-A set up according to the proper measurement and equipment in Figure 1, apply 20V at V_{IN} . Measure V_{OUT} ; it should read 0V. If desired, one can measure the shutdown supply current at this point. The supply current will be approximately $50\mu A$, or less, in shutdown.

2. Turn on the circuit by inserting the shunt in header JP1 (RUN) into the ON position. The output voltage should be regulating. Measure V_{OUT} – it should measure $12V \pm 2\%$ (**Do not apply more than the rated maximum voltage of 60V to the board or the part may be damaged**).
3. Vary the converter load, which should not exceed 25A. Note: all four input and output terminals V_{IN} , V_{OUT} and two GND equipped with two banana connectors, two-wires can be used for each terminal to reduce copper losses and heat dissipation in the interconnection lines.
4. Vary the input voltage from 16V to 55V, the V_{OUT} – it should measure $12V \pm 2\%$
5. Set output current to zero and move jumper JP2 (MODE) into BURST MODE position and measure V_{OUT} – it should register $12V \pm 2\%$.
6. Set output current to zero and move jumper JP2 (MODE) into PLS SKIP position and measure V_{OUT} – it should register $12V \pm 2\%$

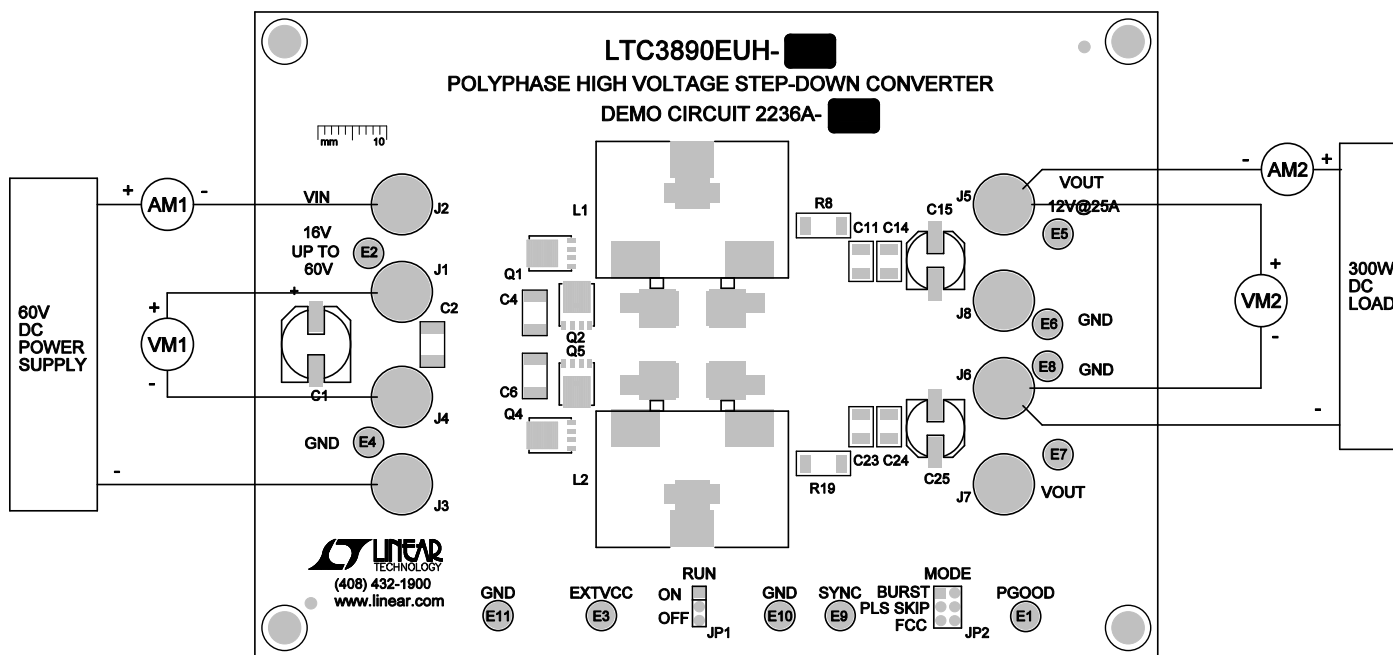

Figure 1. Proper Measurement Equipment Setup

QUICK START PROCEDURE

Table 1. Summary of the Differences Between the Parts in the LTC3890 Family

	LTC3890	LTC3890-1	LTC3890-2	LTC3890-3
I _{LIM} Pin for Adjustable Current Sense Voltage?	Yes	No	Yes	No
CLKOUT and PHASMD Pins for PolyPhase® Operation?	Yes	No	Yes	No
Independent PGOOD Pins for Each Channel	Yes; PGOOD1 and PGOOD2	No; PGOOD1 Only	Yes; PGOOD1 and PGOOD2	No; PGOOD1 Only
Overvoltage Protection Bottom Gate “Crowbar?”	Yes	Yes	No; BG Not Forced On	No; BG Not Forced On
Current Foldback During Overcurrent Events	Yes	Yes	No	No
Light Load Operation When Synchronized to External Clock Using PLLIN/MODE Pin	Forced Continuous	Forced Continuous	Pulse-Skipping	Pulse-Skipping
SENSE Pins Common Mode Range	Operation with SENSE Common Mode < 0.5V Requires V _{FB} < 0.65V	Operation with SENSE Common Mode < 0.5V Requires V _{FB} < 0.65V	Not Dependent on V _{FB} Voltage. Makes It Easy to Make a Non-synchronous Boost or SEPIC Converter with Ground-Referenced Current Sensing	Not Dependent on V _{FB} Voltage. Makes It Easy to Make a Non-synchronous Boost or SEPIC Converter with Ground-Referenced Current Sensing

QUICK START PROCEDURE

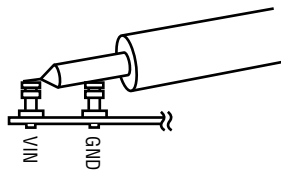

Figure 2. Measuring Input or Output Ripple

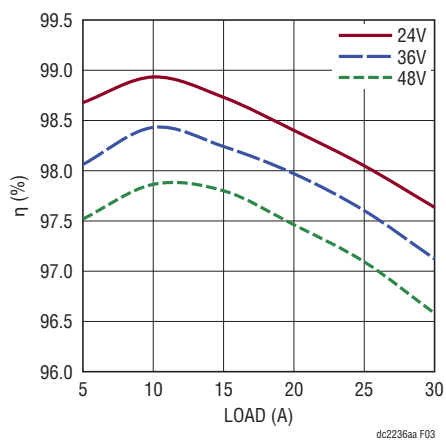

Figure 3. Efficiency vs Load

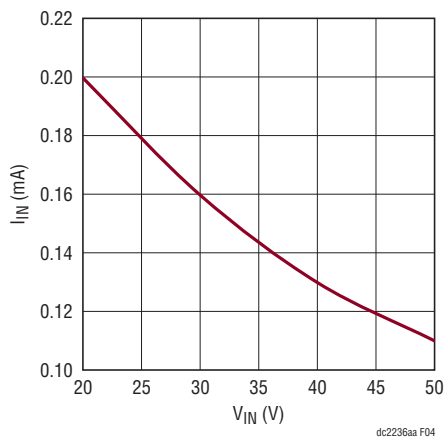

Figure 4. Input Current at No Load vs Input Voltage (Burst Mode)

QUICK START PROCEDURE

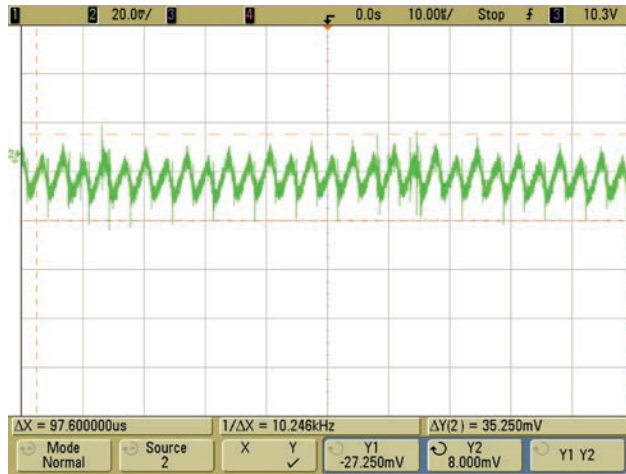

Figure 5. Output Noise, V_{IN} 36V, I_O 12A

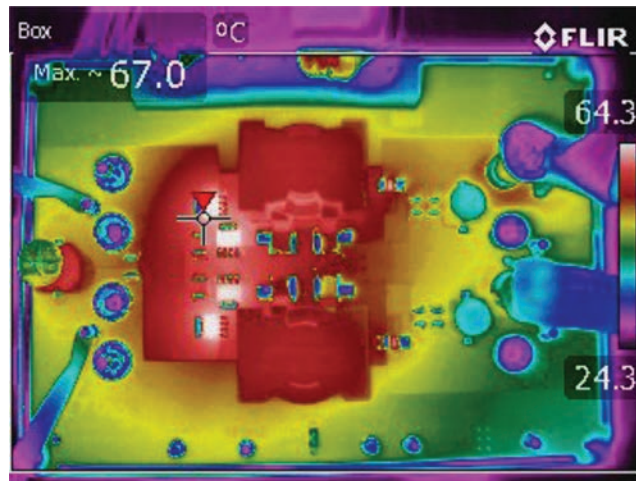

Figure 6. Thermal Map, V_{IN} 48V, V_O 12V, I_O 25A, No Air Flow

DEMO MANUAL DC2236A-A

PARTS LIST

ITEM	QTY	REFERENCE	PART DESCRIPTION	MANUFACTURER/PART NUMBER
Required Circuit Components				
1	2	C1, C29	CAP., ALUM., 56 μ F, 63V, 20%	SUN ELECT., 63HVH56M
2	6	C2, C3, C4, C5, C6, C7	CAP., X7R, 2.2 μ F, 100V, 10%, 1812	TDK, C4532X7R2A225K
3	2	C8, C26	CAP., NPO, 2.2pF, 50V, \pm 0.25pF, 0603	AVX, 06035A2R2CAT
4	1	C9	CAP., X7S, 1 μ F, 100V, 10%, 0805	TDK, C2012X7S2A105K330
5	4	C11, C14, C23, C24	CAP., X5R, 10 μ F, 50V, 1210, 20%	TAIYO YUDEN, UMK325BJ106MM-T
6	3	C12, C16, C21	CAP., X7R, 0.1 μ F, 50V, 10%, 0603	TDK, C1608X7R1H104K
7	2	C15, C25	CAP., SANYO, 150 μ F, 16V, 20%	SANYO, 16TSVPC150
8	1	C17	CAP., X7R, 4.7nF, 100V, 10%, 0603	AVX, 06031C472KAT
9	2	C18, C19	CAP., NPO, 47pF, 25V, 10%, 0603	AVX, 06033A470KAT2A
10	2	C20	CAP., X7R, 4.7 μ F, 10V, 10%, 0603	TAIYO YUDEN, LMK107BJ475KA-T
11	1	C22	CAP., NPO, 10pF, 25V, 10%, 0603	AVX, 06033A100KAT2A
12	1	C27	CAP., X5R, 1 μ F, 25V, 10%, 0603	AVX, 06033D105KAT2A
13	2	D1, D2	DIODE, SCHOTTKY, DFSL1100, PDI-123	DIODES, INC., DFSL1100
14	2	L1, L2	IND., 10 μ H, SMD	COILCRAFT SER2915L-103KL
15	2	Q1, Q4	RENESAS, N CH POWER MOS FET	RENESAS, RJK0651DPB
16	2	Q2, Q5	RENESAS, N CH POWER MOS FET	RENESAS, RJK0653DPB
17	1	R1	RES., 2.2 Ω , 1%, 1/10W, 0603	VISHAY, CRCW06032R20FNEA
18	2	R4, R22	RES., 100 Ω , 1%, 1/10W, 0603	VISHAY, CRCW0603100RFKEA
19	6	R2, R10, R14, R15, R24, R27	RES., 0 Ω , 1/10W, 0603	VISHAY, CRCW06030000Z0EA
20	1	R6	RES., 1M, 5%, 0805	VISHAY, CRCW08051M00JNED
21	1	R7	RES., 30.1k, 1%, 1/10W, 0603	VISHAY, CRCW060330K1FKEA
22	2	R8, R19	RES., 0.003 Ω , 1%, 1/2W, 2010	VISHAY, WSL20103L000FEA
23	1	R9	RES., 57.6k, 1%, 1/10W, 0603	VISHAY, CRCW060357K6FKEA
24	2	R12, R18	RES., 0 Ω , 1/10W, 0805	VISHAY, CRCW08050000Z0EA
25	1	R13	RES., 9.76k, 1%, 1/10W, 0603	VISHAY, CRCW060315K0FKEA
26	1	R16	RES., 499k, 1%, 1/10W, 0603	VISHAY, CRCW0603499KFKEA
27	1	R20	RES., 35.7k, 1%, 1/10W, 0603	VISHAY, CRCW060335K7FKEA
28	2	R21, R29	RES., 100k, 1%, 1/10W, 0603	VISHAY, CRCW0603100KFKEA
29	1	R28	RES., 1k, 1%, 1/10W, 0603	VISHAY, CRCW06031K00FKEA
30	1	U1	I.C., LTC3890EUH-2, QFN-32-UH	LINEAR TECH. LTC3890EUH-2
Additional Demo Board Circuit Components				
1	0	R3, R5, C10, C13, R25, R26, C28	OPT	0603 PACKAGE
2	0	Q3, Q6, Q7, Q8	OPT	LFPACK PACKAGE
Hardware: For Demo Board Only				
1	11	E1-E11	TESTPOINT, TURRET, 0.094"	MILL-MAX, 2501-2-00-80-00-00-07-0
2	2	JP1, JP2	JMP, 3PIN 1 ROW, 0.079"	SAMTEC, TMM-103-02-L-S
3	2	XJP1, XJP2	SHUNT, 0.079" CENTER	SAMTEC, 2SN-BK-G
4	7	J1-J8	CONNECTOR, BANANA JACK	KEYSTONE, 575-4
5	4	MTGS AT 4 CORNERS	STANDOFF, NYLON 0.5 1/2"	KEYSTONE, 8833(SNAP-ON)

SCHEMATIC DIAGRAM

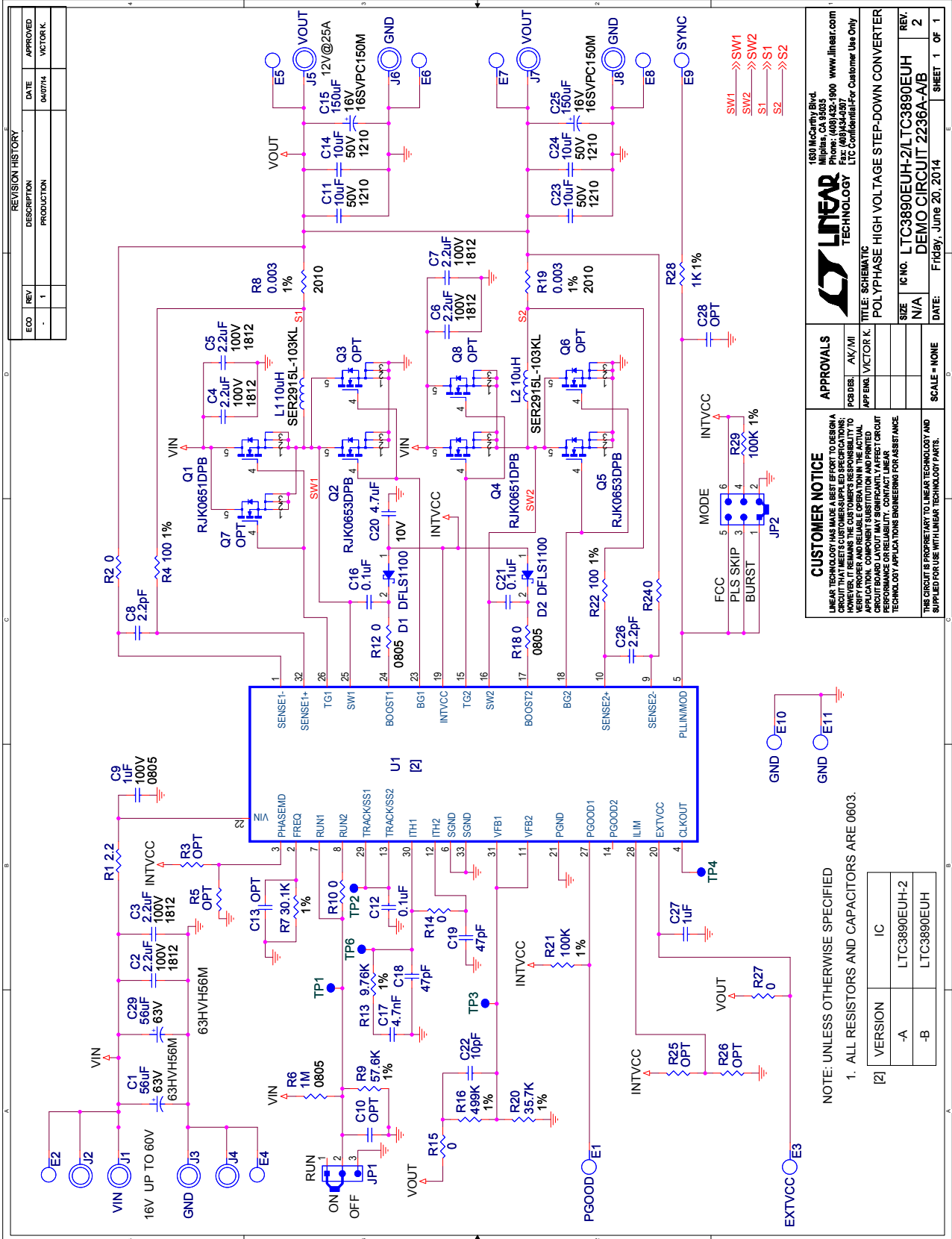

REVISION HISTORY		
ECO	REV	DESCRIPTION
.	1	PRODUCTION
		DATE
		APPROVED
		VICTOR K.

CUSTOMER NOTICE
 LINEAR TECHNOLOGY HAS MADE A BEST EFFORT TO DESIGN A CIRCUIT THAT MEETS CUSTOMER-SUPPLIED SPECIFICATIONS. HOWEVER, THE MANUFACTURER ASSUMES NO LIABILITY FOR ANY APPLICATION, COMPONENT SUBSTITUTION AND PRINTED CIRCUIT BOARD LAYOUT MAY SIGNIFICANTLY AFFECT CIRCUIT PERFORMANCE OR RELIABILITY. CONTACT LINEAR TECHNOLOGY APPLICATIONS ENGINEERING FOR ASSISTANCE.

THIS CIRCUIT IS PROPRIETARY TO LINEAR TECHNOLOGY AND SUPPLIED FOR USE WITH LINEAR TECHNOLOGY PARTS.

APPROVALS

DESIGNER:	AK/MI
APP ENGR:	VICTOR K.

SCALE = NONE

LINEAR TECHNOLOGY

1620 McCarthy Blvd.
 Milpitas, CA 95035
 Phone: (408)438-1900 www.linear.com
 Fax: (408)434-2007
 LTC Confidential-For Customer Use Only

SIZE	IC NO.	TITLE: SCHEMATIC
N/A	LTC3890EUH-2	POLYPHASE HIGH VOLTAGE STEP-DOWN CONVERTER
DATE:	REV.	
Friday, June 20, 2014	2	DEMO CIRCUIT 2236A-A/B
SHEET 1	OF 1	

NOTE: UNLESS OTHERWISE SPECIFIED
 1. ALL RESISTORS AND CAPACITORS ARE 0603.

[2]	VERSION	IC
	-A	LTC3890EUH-2
	-B	LTC3890EUH



Information furnished by Linear Technology Corporation is believed to be accurate and reliable. However, no responsibility is assumed for its use. Linear Technology Corporation makes no representation that the interconnection of its circuits as described herein will not infringe on existing patent rights.

DEMO MANUAL DC2236A-A

DEMONSTRATION BOARD IMPORTANT NOTICE

Linear Technology Corporation (LTC) provides the enclosed product(s) under the following **AS IS** conditions:

This demonstration board (DEMO BOARD) kit being sold or provided by Linear Technology is intended for use for **ENGINEERING DEVELOPMENT OR EVALUATION PURPOSES ONLY** and is not provided by LTC for commercial use. As such, the DEMO BOARD herein may not be complete in terms of required design-, marketing-, and/or manufacturing-related protective considerations, including but not limited to product safety measures typically found in finished commercial goods. As a prototype, this product does not fall within the scope of the European Union directive on electromagnetic compatibility and therefore may or may not meet the technical requirements of the directive, or other regulations.

If this evaluation kit does not meet the specifications recited in the DEMO BOARD manual the kit may be returned within 30 days from the date of delivery for a full refund. **THE FOREGOING WARRANTY IS THE EXCLUSIVE WARRANTY MADE BY THE SELLER TO BUYER AND IS IN LIEU OF ALL OTHER WARRANTIES, EXPRESSED, IMPLIED, OR STATUTORY, INCLUDING ANY WARRANTY OF MERCHANTABILITY OR FITNESS FOR ANY PARTICULAR PURPOSE. EXCEPT TO THE EXTENT OF THIS INDEMNITY, NEITHER PARTY SHALL BE LIABLE TO THE OTHER FOR ANY INDIRECT, SPECIAL, INCIDENTAL, OR CONSEQUENTIAL DAMAGES.**

The user assumes all responsibility and liability for proper and safe handling of the goods. Further, the user releases LTC from all claims arising from the handling or use of the goods. Due to the open construction of the product, it is the user's responsibility to take any and all appropriate precautions with regard to electrostatic discharge. Also be aware that the products herein may not be regulatory compliant or agency certified (FCC, UL, CE, etc.).

No License is granted under any patent right or other intellectual property whatsoever. **LTC assumes no liability for applications assistance, customer product design, software performance, or infringement of patents or any other intellectual property rights of any kind.**

LTC currently services a variety of customers for products around the world, and therefore this transaction **is not exclusive**.

Please read the DEMO BOARD manual prior to handling the product. Persons handling this product must have electronics training and observe good laboratory practice standards. **Common sense is encouraged.**

This notice contains important safety information about temperatures and voltages. For further safety concerns, please contact a LTC application engineer.

Mailing Address:

Linear Technology
1630 McCarthy Blvd.
Milpitas, CA 95035

Copyright © 2004, Linear Technology Corporation