

Drahtführung vorverrastet
wire guide loose mounted

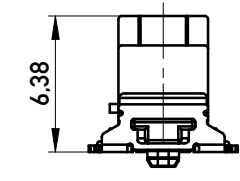

Drahtführung verpresst
wire guide pressed on

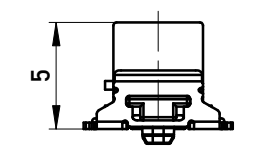

Drahtführungen nicht im Lieferumfang enthalten!
wire guides are not included in delivery!
Ident.Nr. für Drahtführungen (für 600 Teile): 244633
part no. for wire guides (for 600 parts): 244633

Verpackt im Gurt in Anlehnung an DIN IEC 60286-3
Tape on Reel Packaging according to DIN IEC 60286-3
Verpackungseinheit: 600 Stück
Packaging unit: 600 pcs

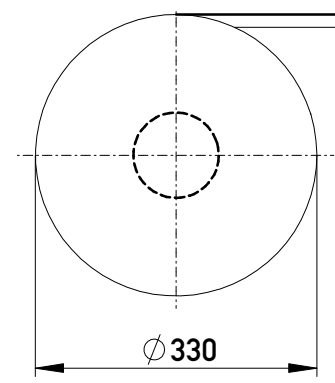
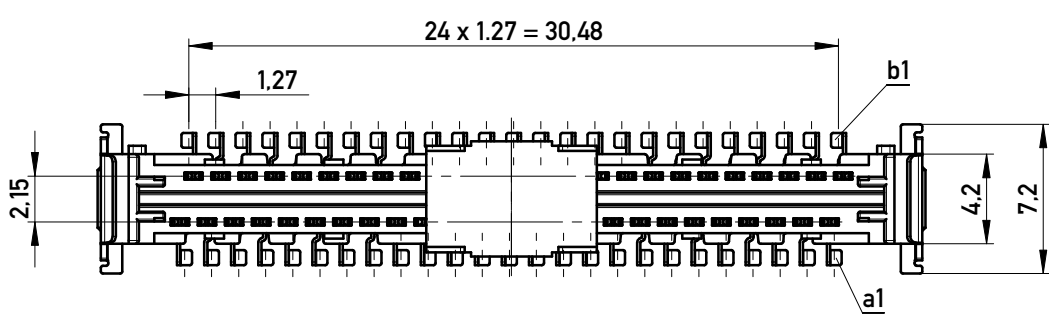

Abspulrichtung - Reel off Direction

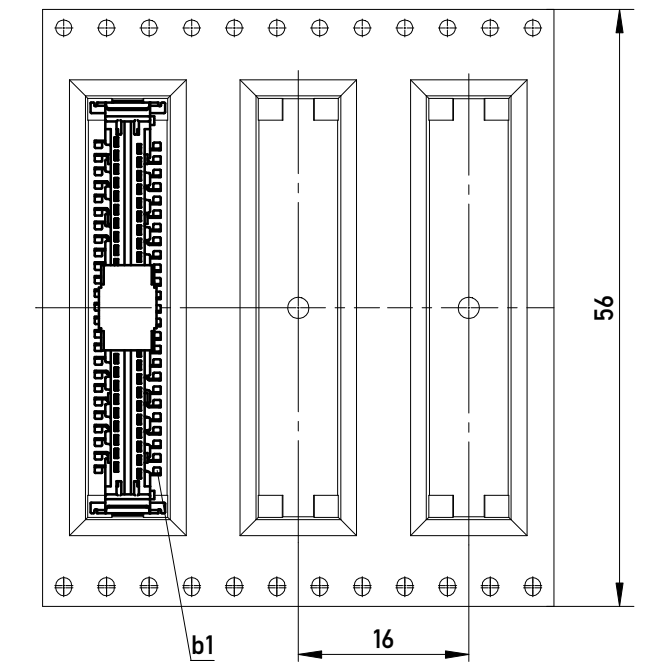

Leiterplatten-Layout Vorschlag für SMT
PCB-Layout Proposal for SMT

Kontaktbezeichnung bei b1
contact marking at b1

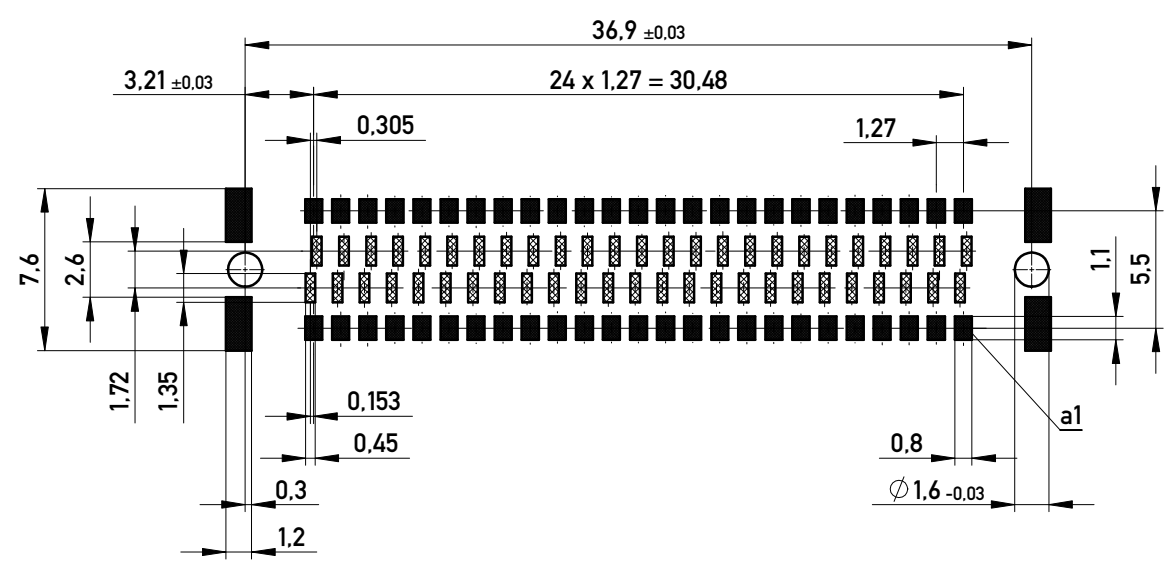

Leiterplatten-Layout Rückseite
PCB-Layout Back Side

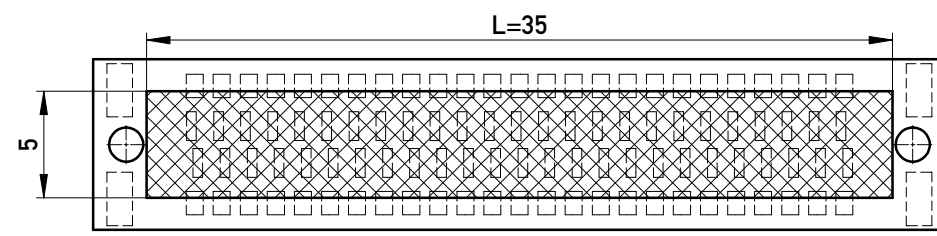

Freifläche Lx5mm auf der Leiterplatten-Unterseite
für das Einpresswerkzeug. Keine Bauteile plazieren in diesem Bereich.
PCB back side space Lx5mm for press tool.
Do not place any parts in this space.

Sperrfläche
Restricted area

Information:	Tolerances	Scale 3:1	Designation 1,27 DRC board on IDC 50-polig 50-contacts
	All rights reserved. Only for Information. To ensure that this is the latest version of this drawing, please contact one of the ERNI companies before using.		
Copyright by ERNI Production GmbH & Co. KG Proprietary notice pursuant to ISO 16016 to be observed.	Subject to modification without prior notice. Drawing will not be updated.	www.ERNI.com	244630
	Index		Date 18.01.2017