

**ebm-papst St. Georgen GmbH & Co. KG**

Hermann-Papst-Str. 1

D-78112 St. Georgen

Phone +49 (0) 7724 81-0

Fax +49 (0) 7724 81-1309

info2@de.ebmpapst.com

www.ebmpapst.com

Nominal data

Type	634 NU	
Nominal voltage	VDC	24
Nominal voltage range	VDC	12 .. 30
Speed (rpm)	min ⁻¹	5900
Power consumption	W	1.6
Min. ambient temperature	°C	-20
Max. ambient temperature	°C	70
Air flow	m ³ /h	40
Sound power level	B	5.1
Sound pressure level	dB(A)	34

ml = Max. load · me = Max. efficiency · fa = Free air · cs = Customer specification · ce = Customer equipment
Subject to change



Technical description

General description	Developed for applications with high environmental requirements
Housing material	Glass-fiber reinforced PBT plastic
Impeller material	Glass-fiber reinforced PA plastic
Weight	0.070 kg
Dimensions	60 x 60 x 25 mm
Airflow direction	Exhaust over struts
Direction of rotation	Clockwise, viewed toward rotor
Storage	Ball bearing
Service life L10 at 40 °C	85000 h
Service life L10 at maximum temperature	42500 h
Cable	With leads AWG 22, TR 64
Option	Possible custom designs: Speed signal Go / No-go alarm Alarm with speed limit External temperature sensor PWM control input Analog control input Moisture protection Salt spray protection Degree of protection: IP54 / IP68

Product drawing

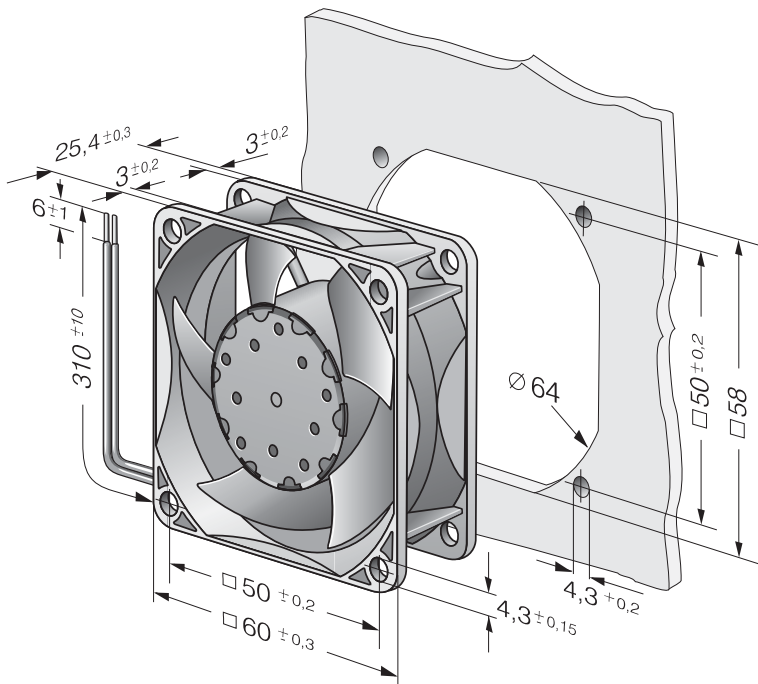

Curves

