

**ebm-papst St. Georgen GmbH & Co. KG**

Hermann-Papst-Str. 1  
 D-78112 St. Georgen  
 Phone +49 (0) 7724 81-0  
 Fax +49 (0) 7724 81-1309  
 info2@de.ebmpapst.com  
 www.ebmpapst.com

**Nominal data**

Type	3314 NH3	
Nominal voltage	VDC	24
Nominal voltage range	VDC	12 .. 28
Speed (rpm)	min <sup>-1</sup>	4350
Power consumption	W	6.0
Min. ambient temperature	°C	-20
Max. ambient temperature	°C	75
Air flow	m <sup>3</sup> /h	133
Sound power level	B	6.0
Sound pressure level	dB(A)	50

ml = Max. load · me = Max. efficiency · fa = Free air · cs = Customer specification · ce = Customer equipment  
 Subject to change



**Technical description**

<b>Weight</b>	0.19 kg
<b>Dimensions</b>	92 x 92 x 32 mm
<b>Impeller material</b>	Glass-fiber reinforced PA plastic
<b>Housing material</b>	Glass-fiber reinforced PBT plastic
<b>Airflow direction</b>	Exhaust over struts
<b>Direction of rotation</b>	Clockwise, viewed toward rotor
<b>Bearing</b>	Ball bearing
<b>Service life L10 at 40 °C</b>	60.000 h
<b>Service life L10 at maximum temperature</b>	25.000 h
<b>Cable</b>	With leads AWG 24 UL 1061, TR 64

Product drawing

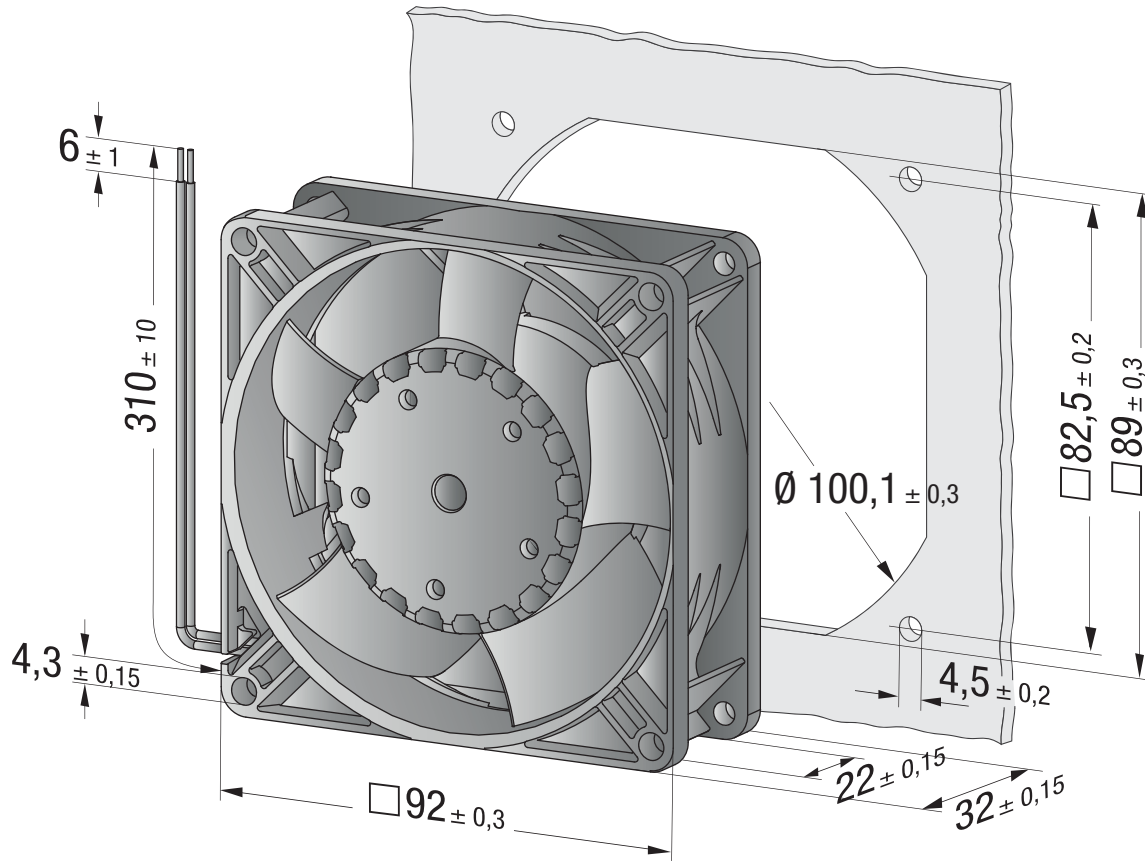

Curves

