



**SPECIFICATION SHEET**

<b>SPECIFICATION SHEET NO.</b>	N0310-DBS207S000S20A
<b>DATE</b>	Mar. 10, 2021
<b>REVISION</b>	A0
<b>DESCRIPTION</b>	SMD Single Phase Glass Passivated Bridge Rectifier, DBS series, DB207S Type 4 Pads, Reverse Voltage 1000V Max. Forward Current 2.0A Max. Operating Temp. Range -55°C ~+150°C, Package in Tape/Reel, 1000pcs/Reel RoHS/RoHS III compliant
<b>CUSTOMER</b>	
<b>CUSTOMER PART NUMBER</b>	
<b>CROSS REF. PART NUMBER</b>	
<b>ORIGINAL PART NUMBER</b>	MDD DB207S
<b>PART CODE</b>	DBS207S000S20A

<b>VENDOR APPROVE</b>			
Issued/Checked/Approved			
DATE: March 10, 2021			

<b>CUSTOMER APPROVE</b>	
DATE:	

**SMD BRIDGE RECTIFIER DBS SERIES**



**MAIN FEATURE**

- Reliable low cost construction utilizing molded plastic technique
- Small size simple installation
- High forward surge current capability
- High temperature soldering guaranteed.
- 260 °C/10 seconds, at 5 lbs (2.3kg) tension

**APPLICATION**

- For printed circuit board

**RFQ**

[Request For Quotation](#)

**PART CODE GUIDE**

DBS	207S000	S	20A
1	2	3	4

- 1) **DBS**: SMD Single Phase Glass Passivated Bridge Rectifier, 4 Pads, DBS series
- 2) **207S000**: Type code for original part number DB207S
- 3) **S**: Package code, Tape/reel, 1000pcs/reel.
- 4) **20A**: Specification code for Reverse Voltage 1000V Max. Forward Current 2.0A Max.

**MORE ITEMS AVAILABLE**

DBS101S000S105	DBS102S000S110	DBS103S000S120	DBS104S000S140	DBS105S000S160
DBS106S000S180	DBS107S000S10A			
DBS151S000S150	DBS152S000S151	DBS153S000S152	DBS154S000S154	DBS155S000S156
DBS156S000S158	DBS157S000S15A			
DBS201S000S205	DBS202S000S210	DBS203S000S220	DBS204S000S240	DBS205S000S260
DBS206S000S280	<b>DBS207S000S20A</b>			

**SMD BRIDGE RECTIFIER DBS SERIES**

**DIMENSION (Unit: Inch/mm)**

Image for reference

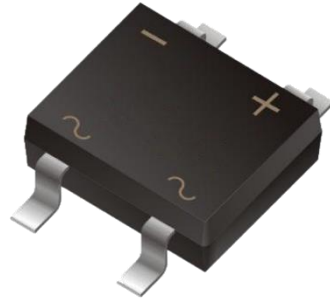

Marking: DB207S

DBS

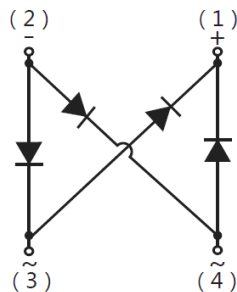
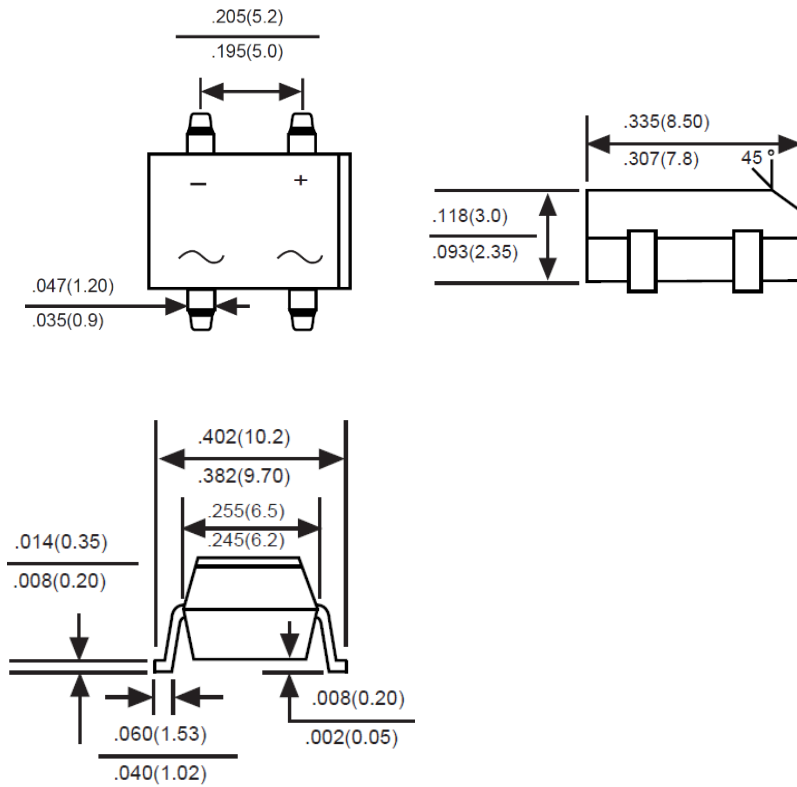

**SMD BRIDGE RECTIFIER DBS SERIES**
**MECHANICAL DATA**

Case	Terminals	Polarity	Mounting Position	Weight per piece
JEDEC DBS molded plastic body	Solder plated, Solderable per MIL-STD-750, Method 2026	Polarity symbol marking on case	Any	0.020 Ounce, 0.622 grams

**MAX. RATING & CHARACTERISTICS**

Parameter	SYMBOLS	VALUE			UNITS
		Min.	Typical	Max.	
Repetitive peak reverse voltage	V <sub>RRM</sub>			1000	Volts
RMS voltage	V <sub>RMS</sub>			700	Volts
DC blocking voltage	V <sub>DC</sub>			1000	Volts
Average forward output rectified current at T <sub>c</sub> = 40°C	I <sub>AV</sub>			2.0	A
Peak forward surge current 8.3ms single half sine-wave superimposed on rated load (JEDEC Method)	I <sub>FSM</sub>		60		A
Instantaneous forward voltage at 2.0A	V <sub>F</sub>			1.10	Volts
DC reverse current at rated DC blocking voltage	I <sub>R</sub>			10	μA
				500	μA
Junction capacitance	C <sub>J</sub>		-		pF
Thermal resistance	R <sub>QA</sub>		-		°C/W
Operating junction temperature range	T <sub>J</sub>	-55		+150	
Storage temperature range	T <sub>STG</sub>	-55		+150	°C

**Note**

1. Ratings at 25 C ambient temperature unless otherwise specified. Single phase half-wave 60Hz, resistive or inductive load, for capacitive load current derate by 20%.

**SMD BRIDGE RECTIFIER DBS SERIES**
**RELIABILITY**

Number	Experiment Items	Experiment Method And Conditions	Reference Documents
1	Solder Resistance Test	Test 260°C± 5°C for 10 ± 2 sec. Immerse body into solder 1/16" ± 1/32"	MIL-STD-750D METHOD-2031.2
2	Solderability Test	230°C ±5°C for 5 sec.	MIL-STD-750D METHOD-2026.1 0
3	Pull Test	1 kg in axial lead direction for 10 sec.	MIL-STD-750D METHOD-2036.4
4	Bend Test	0.5Kg Weight Applied To Each Lead, Bending Arcs 90 °C ± 5 °C For 3 Times	MIL-STD-750D METHOD-2036.4
5	High Temperature Reverse Bias Test	TA=100°C for 1000 Hours at VR=80% Rated VR	MIL-STD-750D METHOD-1038.4
6	Forward Operation Life Test	TA=25°C Rated Average Rectified Current	MIL-STD-750D METHOD-1027.3
7	Intermittent Operation Life Test	On state: 5 min with rated IRMS Power Off state: 5 min with Cool Forced Air. On and off for 1000 cycles.	MIL-STD-750D METHOD-1036.3
8	Pressure Cooker Test	15 PSIG, TA=121°C, 4 hours	MIL-S-19500 APPENOIXC
9	Temperature Cycling Test	-55°C~+125°C; 30 Minutes For Dwelled Time 5 minutes for transferred time. Total: 10 cycles.	MIL-STD-750D METHOD-1051.7
10	Thermal Shock Test	0°C for 5 minutes., 100°C for 5minutes, Total: 10 cycles	MIL-STD-750D METHOD-1056.7
11	Forward Surge Test	8.3ms Single Sale Sine-wave One Surge.	MIL-STD-750D METHOD-4066.4
12	Humidity Test	TA=65°C, RH=98% for 1000 hours.	MIL-STD-750D METHOD-1021.3
13	High Temperature Storage life Test	150°C for 1000 Hours	MIL-STD-750D METHOD-1031.5

**SMD BRIDGE RECTIFIER DBS SERIES**

**SUGGESTED REFLOW PROFILE (For Reference Only)**

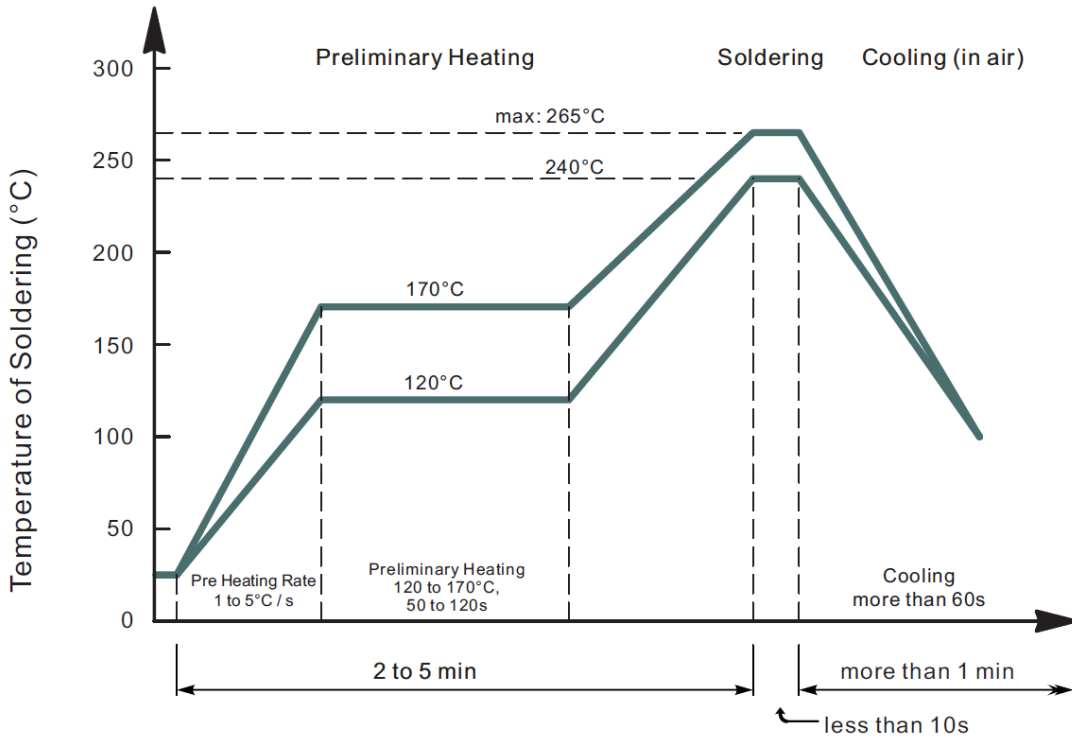

- Recommended peak temperature is over 245°C, If peak temperature is below 245 °C, you may adjust the following parameters; time length of peak temperature (longer), time length of soldering (longer), thickness of solder paste (thicker)
- Welding shall not exceed 2 times
- Remark: lead free solder paste (96.5 sn/3.0 Ag/0.5Cu)

**SMD BRIDGE RECTIFIER DBS SERIES**

**RATINGS AND CHARACTERISTIC CURVES (For Reference Only)**

**FIG. 1- MAXIMUM DERATING CURVE FOR OUTPUT RECTIFIED CURRENT**

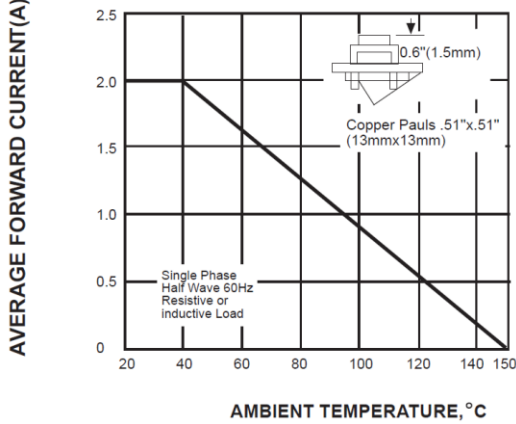

**FIG. 2-MAXIMUM NON-REPETITIVE PEAK FORWARD SURGE CURRENT**

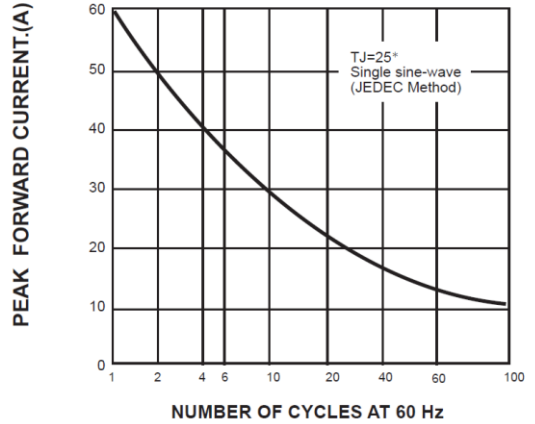

**FIG. 3-TYPICAL REVERSE CHARACTERISTICS PER BRIDGE ELEMENT**

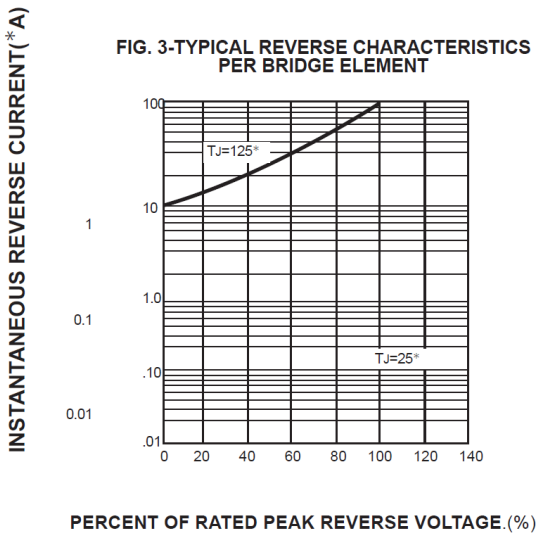

**FIG. 4-TYPICAL FORWARD CHARACTERISTICS PER BRIDGE ELEMENT**

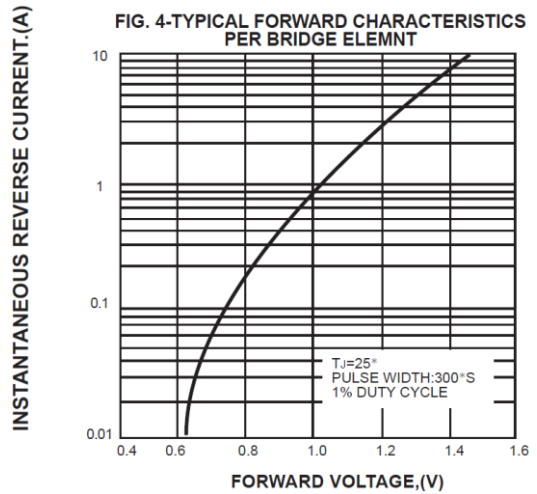

**FIG. 3-TYPICAL JUNCTION CAPACITANCE PER BRIDGE ELEMENT**

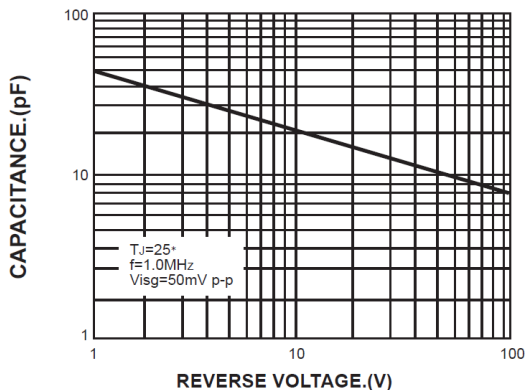

**SMD BRIDGE RECTIFIER DBS SERIES**

**TAPE/REEL (Unit: mm)**

All Devices are packed in accordance with EIA standard RS-481-A and specifications.

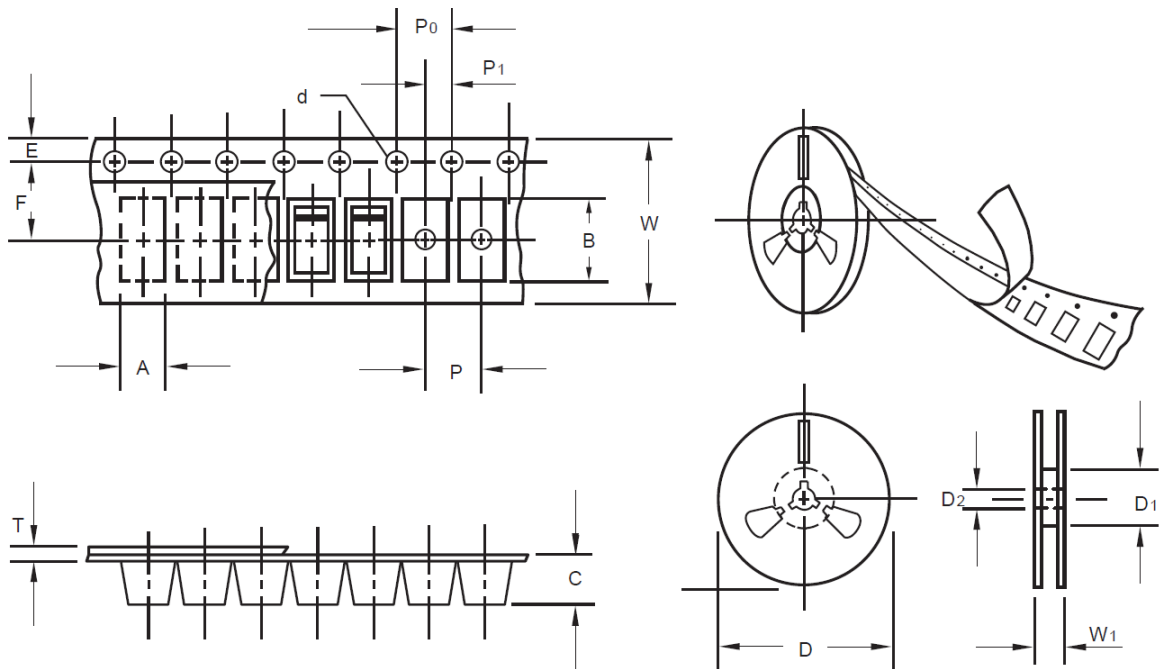

Item	Symbol	Tolerance	DBS
Carrier width	A	0.1	2.8
Carrier Length	B	0.1	5.33
Carrier Depth	C	0.1	2.36
Sprocket hole	d	0.05	1.50
13" Reel outside diameter	D	2.0	330.00
13" Reel inner diameter	D1	Min.	50.00
7" Reel outside diameter	D	-	-
7" Reel inner diameter	D1	-	-
Feed hole diameter	D2	0.5	13.00
Sprocket hole position	E	0.1	1.75
Punch hole position	F	0.1	5.50
Punch hole pitch	P	0.1	4.00
Sprocket hole pitch	P0	0.1	4.00
Embossment center	P1	0.1	2.0
Overall tape thickness	T	0.1	0.28
Tape width	W	0.3	12.00
Reel width	W1	1.0	18.0



**SMD BRIDGE RECTIFIER DBS SERIES**

**PACKAGE**

Case Code	Reel Size	MPQ (pcs)	Component Spacing (mm)	Qty. Per Box (pcs)	Inner Box L*W*H (mm)	Reel Size (mm)	Carton size L*W*H (mm)	Qty. Per Carton (pcs)	G. W (kg)
DBS	13"	2,000		4,000	190*190*41	330	320*320*280	10,000	6.90

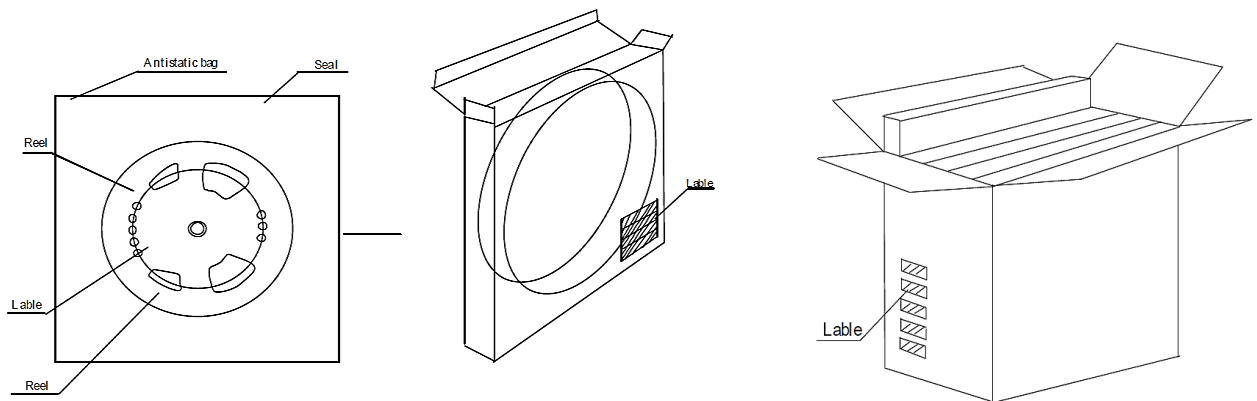

**DISCLAIMER**

NextGen Component, Inc. reserves the right to make changes to the product(s) and or information contained herein without notice. No liability is assumed as a result of their use or application. No rights under any patent accompany the sale of any such product(s) or information