



Part Number: D4I8012

Electrical Specifications

Frequency Range (GHz):	8.0 – 12.4
Isolation (dB):	40 MIN
Insertion Loss (dB):	1.0 MAX
VSWR:	1.25:1 MIN
Forward Power (W):	25 AVG 500 PK
Reflective Power (W):	2 AVG

Mechanical/Environmental Specifications

Connector Type:	SMA
Connector Body:	Passivated stainless steel
Connector Pin:	Gold plated copper
Load Body:	Brass
Magnetic Shunt:	Nickel plated CRS
Operational Temp:	-30°C to +85°C
Weight (oz)	2.0 MAX

D4I8012 Dimensions

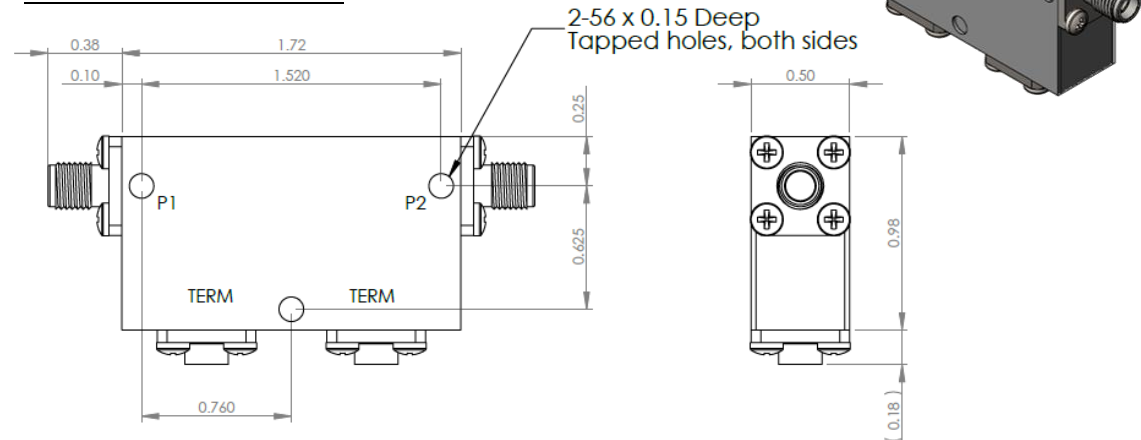

D4I8012-3 Dimensions

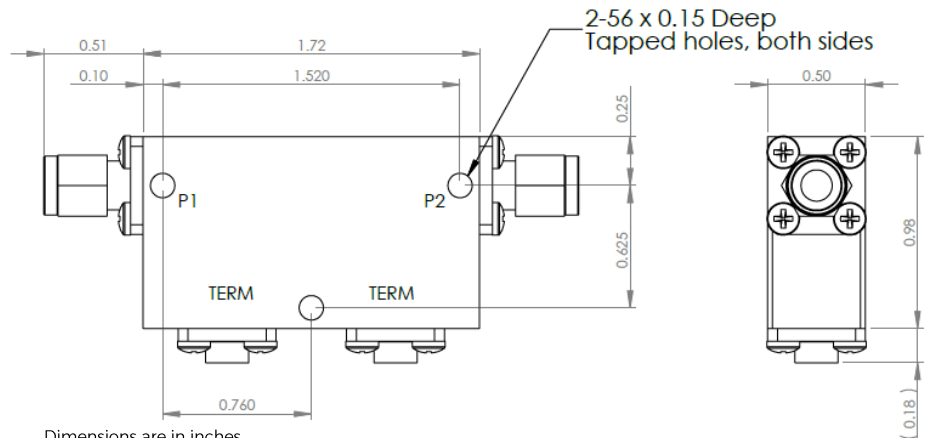

Dimensions are in inches
Tolerance

XX	±0.03
XXX	±0.010

Type of Device	PN Suffix	Connector Configuration Input / Output	PN Example
Single and Dual Junction Isolator, 2-Port Device	N/A	Female / Female	D4I8012
	-1	Male / Female	D4I8012-1
	-2	Female / Male	D4I8012-2
	-3	Male / Male	D4I8012-3



MEASURED DATA

Part Number: D4I8012, +25°C

