



Part Number: D4I3060

Electrical Specifications

Frequency Range (GHz):	3.0 - 6.0
Isolation (dB):	36 MIN
Insertion Loss (dB):	1.0 MAX
VSWR:	1.3:1 MIN
Forward Power (W):	25 AVG 50 PK
Reflective Power (W):	2 AVG

Mechanical/Environmental Specifications

Connector Type:	SMA
Connector Body:	Passivated stainless steel
Connector Pin:	Gold plated copper
Load Body:	Brass
Magnetic Shunt:	Nickel plated CRS
Operational Temp:	0°C to +50°C
Weight (oz)	4.0 MAX

D4I3060 Dimensions

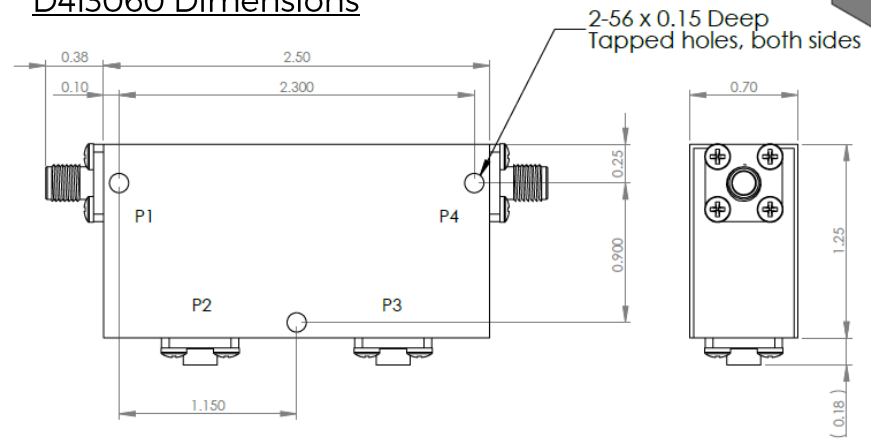

D4I3060-3 Dimensions

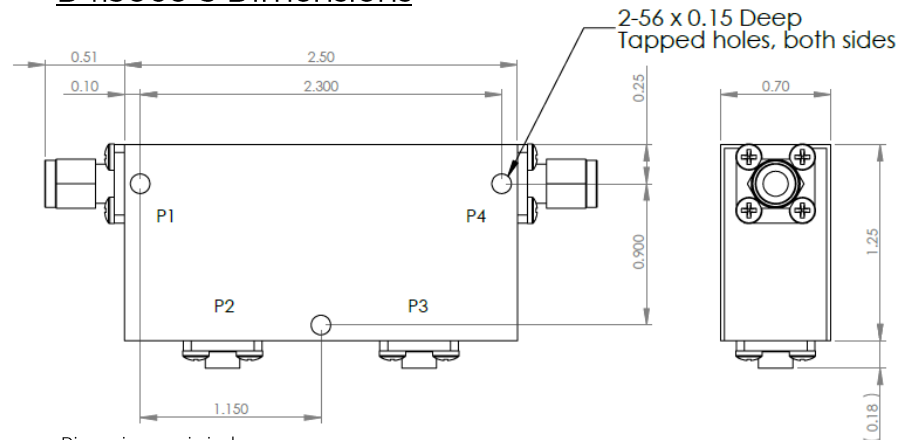

Dimensions are in inches
Tolerance

XX ±0.03
XXX ±0.010

Type of Device	PN Suffix	Connector Configuration Input / Output	PN Example
Single and Dual Junction Isolator, 2-Port Device Input / Output	N/A	Female / Female	D4I3060
	-1	Male / Female	D4I3060-1
	-2	Female / Male	D4I3060-2
	-3	Male / Male	D4I3060-3



MEASURED DATA

Part Number: D4I3060, +25°C

