



## Part Number: D4C8020

### Electrical Specifications

Frequency Range (GHz):	8.0 – 20.0
Isolation (dB):	15 MIN (per junction)
Insertion Loss (dB):	1.0 MAX (per junction)
VSWR:	1.45:1 MIN
Forward Power (W):	5 AVG 30 PK

### Mechanical/Environmental Specifications

Connector Type:	SMA
Connector Body:	Passivated stainless steel
Connector Pin:	Gold plated copper
Load Body:	Brass
Magnetic Shunt:	Nickel plated CRS
Operational Temp:	-20°C to +65°C
Weight (oz)	2.0 MAX

### D4C8020 Dimensions

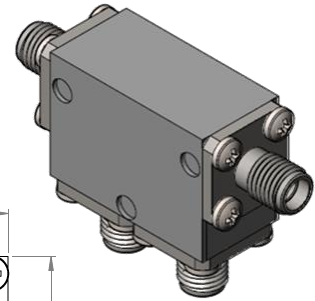
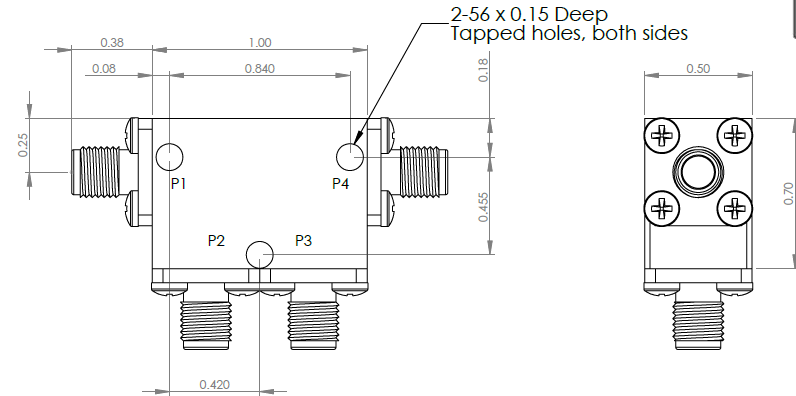

### D4C8020-3 Dimensions

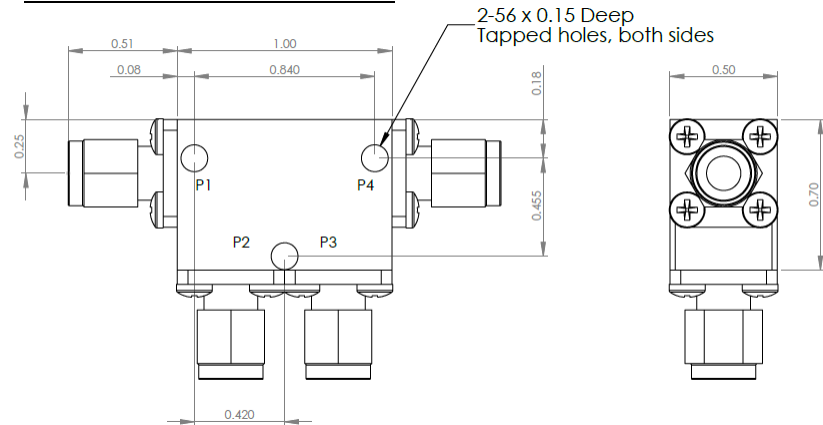

Dimensions are in inches  
Tolerance  
XX ±0.03  
XXX ±0.010

Type of Device	PN Suffix	Connector Configuration Input / Output	PN Example
Dual Junction Circulator 4-Port Device Port 1 / Port 2 / Port 3 / Port 4	No Dash	Female / Female / Female / Female	D4C8020
	-1	Male / Female / Female / Female	D4C8020-1
	-2	Female / Male / Female / Female	D4C8020-2
	-3	Male / Male / Male / Male	D4C8020-3
	-4	Female / Female / Male / Female	D4C8020-4
	-5	Female / Female / Female / Male	D4C8020-5



## MEASURED DATA

Part Number: D4C8020, P4→P1, P2 & P3 Terminated with 50Ω, +25°C

