

High-Coded Guard Lock Safety Door Switch (For Gate) D41G

Prevent people from being trapped inside hazardous areas



- Minimize defeat and prevent safety door switch bypassing
- Integrated door handle offers ergonomic actuator and reduces guard-related design efforts
- Optional emergency exit can be activated from inside a hazardous area, allowing people to escape even during a power failure
- Available actuator types include hinged left and right doors and sliding doors
- Slim housing to match aluminum profiles used in guarding applications
- Complies with ISO 14119 (Type 4/High Coded), ISO 13849-1 (PLe)



* The actuator is sold separately.

Refer to *Safety Precautions* on page 25

For the most recent information on models that have been certified for safety standards, refer to your OMRON website.

Features

Application example

Access to hazardous areas for maintenance activities

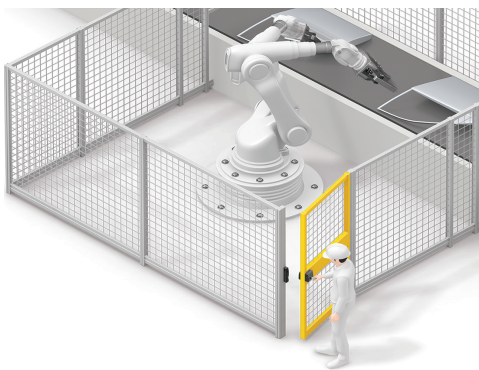

Escape hazardous areas by using the emergency exit, even if the power supply is not available.

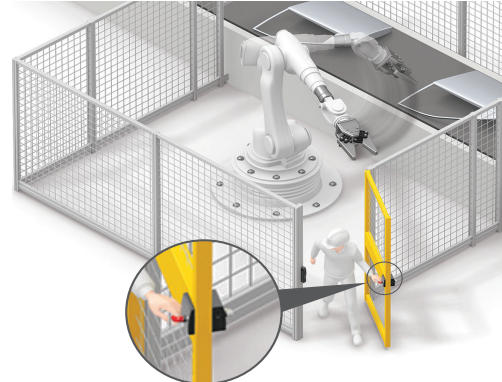

Actuator with integrated emergency exit unit D41G-A2□-E1

- Different accessory types, including actuators with door handles, reduce guard design time.
- The switch can be unlocked even when power is not supplied, preventing people from being trapped inside a dangerous area.

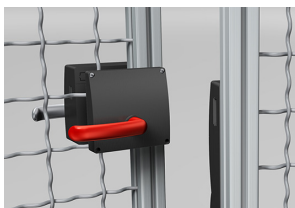

Manual release allows manual unlock of the switch in a locked condition

Unnecessary locks can be prevented during setup. (Refer to *Manual Release* on page 13.)

Component ready for operation

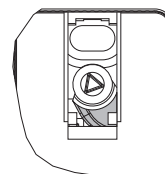

Component not ready for operation

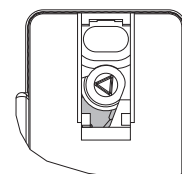

For actuator coding, EN ISO 14119 also introduces a coding level classification that is applicable independently of the technology used. A high-coded safety switch is defined as one where a sensor is paired with a high-level coded actuator for more than 1,000 variations are available.

D41G

Model Number Structure

Model Number Legend

Safety Door Switch Switch

D41G - □ □ **D** □ - □
(1) (2) (3) (4) (5) (6)

(1) Model

G: Guard Lock (For Gate)

(2) Coding level / Teaching limitation

1: High (Individual coding) / Teaching is not-repeatable

2: High (Individual coding) / Teaching is repeatable

(3) OSSD configuration

Y: Guard monitoring AND lock monitoring

Z: Only guard monitoring

(4) Diagnosis output

D: With diagnosis output

(5) Lock and release

A: Power to unlock (Mechanical lock / Solenoid release)

G: Power to lock (Solenoid lock/ Mechanical release)

(6) Connection method

N2: M12 Connector

T1: Screw terminal (Conduit outlet M20)

Actuator

D41G - **A** □ □ - □ □
(1) (2) (3) (4) (5)

(1) Model

G: Guard Lock (For Gate)

(2) Actuator type

A1: None door-handle (for sliding safety guards)

A2: With door-handle (for hinged or sliding safety guards)

(3) Handle position

L: Left (Actuator is installed on left of switch)

R: Right (Actuator is installed on right of switch)

(4) Emergency function

Blank: None function

E0: With emergency release tab (D41G-A1 only)

E1: With emergency exit unit (D41G-A2 only)

(5) Lock-out option (D41G-A2 only)

Blank: None option

T: With Lock-out tag











Ordering Information

List of Models

Switches

Classification (Lock and Release)	Appearance	Coding level / Teaching limitation	OSSD configuration	Connection method	Model	
Power to unlock (Mechanical lock/ Solenoid release)		High / Teaching is not-repeatable	Guard monitoring AND lock monitoring	Screw terminal	D41G-1YDA-T1	
				M12 Connector	D41G-1YDA-N2	
		High / Teaching is repeatable	Guard monitoring AND lock monitoring	Only guard monitoring	Screw terminal	D41G-2ZDA-T1
				Guard monitoring AND lock monitoring	M12 Connector	D41G-2YDA-N2
Power to lock (Solenoid lock/ Mechanical release)			High / Teaching is repeatable	Only guard monitoring	Screw terminal	D41G-2ZDG-T1
					M12 Connector	D41G-2ZDG-N2
			Guard monitoring AND lock monitoring	Screw terminal	D41G-2YDG-T1	
				M12 Connector	D41G-2YDG-N2	

Actuators (Sold separately)

Actuator type	Appearance	Handle position	Emergency function	Lock-out option	Model
With door-handle		Left	---	---	D41G-A2L
			With emergency exit unit	---	D41G-A2L-E1
			With emergency exit unit	With Lock-out tag	D41G-A2L-E1T
		Right	---	---	D41G-A2R
			With emergency exit unit	---	D41G-A2R-E1
			With emergency exit unit	With Lock-out tag	D41G-A2R-E1T
None door-handle		Left	---	---	D41G-A1L
			With emergency release tab	---	D41G-A1L-E0
		Right	---	---	D41G-A1R
			With emergency release tab	---	D41G-A1R-E0

Accessory (Sold separately)

Connecting cables

Appearance	Name	Features	Cable length	Model
	Connecting cables with Connector M12	Connecting cable with connector (M12) (female), 8-pole – 8 x 0.25 mm ² , straight, IP69	5 m	D41L-8P5-CFM12-905M
10 m			D41L-8P5-CFM12-910M	

D41G

Standards Certification

Directives

- Machinery Directive
- RE Directive
- RoHS Directive
- WEEE Directive



Dispose in accordance with applicable regulations.

Standards

- EN ISO 13849-1: PL e Category 4
- EN 60947-5-3
- EN 300 330
- IEC 61508
- EN 62061
- EN ISO 14119

UL Certification

- UL508
- CAN/CSA C22.2 No.14

Regions where D41G can be used

The product can be used in Japan, the United States, Canada, EU member states, the United Kingdom, China, Australia, and New Zealand. The use in other countries may conflict with radio laws of the countries.

Ratings and Specifications

Model		D41G
Technical		
Detection method	RFID	
Frequency band	125 kHz	
Transmitter outputs	-6 dBm max.	
Interlock type (ISO 14119)	Type 4	
Coded level (ISO 14119)	High	
Actuator *1	D41G-A1, D41G-A2	
Response time (ON to OFF)	100 ms max.	
Response time (input)	1.5 ms max.	
Risk time	200 ms max.	
Startup time	4 s max.	
Electrical		
Supply voltage (Ue)	24 VDC -15%/+10% (stabilized PELV power supply)	
Current consumption (Io)	0.05 A max.	
Overvoltage category	III	
Pollution degree	3	
Operating current device with magnet switched on	Average < 0.2 A Peak < 0.7 A/100 ms	
Conditional short-circuit current	100 A	
External device fuse rating	Screws or cage clamps 4 A max. (UL508 compliant) Connector M12 2 A max.	
Safety input	Switching thresholds	-3 to 5 V (low) 15 to 30 V (high)
	Current consumption per input	2 mA/24 V (typical)
	Accepted test pulse duration on input signal	1.0 ms max.
	Test pulse interval	100 ms min.
Safety output (OSSD)	Switching element	PNP type, short-circuit proof
	Utilization category	DC-13: 24 VDC (Ue)/0.25 A (Ie)
	Rated operating current (Ie)	Each 0.25 A max.
	OFF-state leakage current (Ir)	0.5 mA max.
	Voltage Drop (Ud)	4 V max.
	Cross-wire monitoring by device	Yes
	Test pulse duration	<0.5 ms
Auxiliary output	Test pulse interval	1000 ms
	Switch element	PNP type, short-circuit proof
	Utilization category	DC-13: 24 VDC (Ue)/0.05 A (Ie)
	Rated operating current (Ie)	0.05 A max.
Solenoid	Voltage drop (Ud)	4 V max.
	Switching thresholds	-3 to 5 V (low) 15 to 30 V (high)
	Power consumption	10 mA/24 V (typical) 20 mA (dynamic)
	Duty ratio solenoid (ED)	100%
	Accepted test pulse duration on input signal	5.0 ms max.
	Test pulse interval	40 ms min.
Protection class	III	
Switching frequency	1 Hz max.	
Rated insulation voltage (Ui)	32 VDC	
Rated impulse withstand voltage (Uimp)	0.8 kV	
Minimum operating current (Im)	0.5 mA	

D41G

Model	D41G
Mechanical	
Fixing screws	2 × M6
Tightening torque of fixing screws	8 N·m
Tightening torque of cover screw	0.7 to 1.0 N·m (Torx T10)
Latching force	30 N
Holding force (Fzh) (min.)	2,000 N
Operating speed	0.2 m/s max.
Mechanical durability	1,000,000 operations min.
Material	Fiberglass reinforced thermoplastic self-digestion (enclosure)
Weight	Unit: <510 g, Packaged: <600 g
Environmental	
Ambient operating temperature	-10 to 55°C
Ambient operating humidity	93% max. (non-condensing, non-icing)
Degree of protection (IEC 60529)	IP66 and IP67
Vibration resistance	10 to 150 Hz, amplitude 0.35 mm
Shock resistance	30 g/11 ms
Connection	
Series connection	31 max. *2
Cable lengths	40 m max. (between switch and power supply)
Connection	Screw terminal or connector M12
Cable type	Rigid single-wire or rigid multi-wire
Cable section	0.25 mm ² min. 1.5 mm ² max. (including conductor ferrules)
Cable entry	M20

*1. D41G-A1 is suitable for sliding safety guards and D41G-A2 is for hinged or sliding safety guards.

*2. Refer to the *Connection* on page 12 for connection specifications with the Safety controller.

Safety classification information

Interlocking function	
Standard	ISO 13849-1, IEC 61508, IEC 62061
PL	e
DC	99%
Safety Category	4
PFH	$1.9 \times 10^{-9}/h$
PFD	1.6×10^{-4}
SIL	Suitable for SIL3 applications
Mission time	20 years

Guard lock function	
Standard	ISO 13849-1, IEC 61508, IEC 62061
PL	d
DC	99%
Safety Category	2
PFH	$1.0 \times 10^{-8}/h$
PFD	8.9×10^{-4}
SIL	Suitable for SIL2 applications
Mission time	20 years

- Note:**
1. The actuation of the interlock must be compared with the external OSSD enabler. If a shut-down now occurs due to an unintentional unlocking this is detected by an external diagnostic.
 2. The safety consideration of the guard locking function only applies for monitored safety door switch D41G-□Y.
 3. If for a certain application the power-to-unlock type of a safety door switch cannot be used, then for this exception the power-to-lock type of a safety door switch can be used if additional safety measure need to be realized that have an equivalent safety level.
 4. The safety analysis of the guard locking function refers to the component safety door switch as part of the complete system. In the event of a fault resulting in the unlocking of the guard locking, this is detected by the safety outputs Y1/Y2 of the safety door switch switch off. When such a fault occurs the protection equipment may open immediately, just once, before the safe condition of the machine is reached. The system reaction of category 2 allows that a fault can occur between tests causing the loss of the safety function which is detected by the test.
 5. If multiple safety door switches are involved in the same safety function, the PFH values of the individual components must be added.

UL

Use isolated power supply only.

For use in NFPA 79 Applications only.

Adapters providing field wiring means are available from the manufacturer. Refer to manufacturers information.

FCC

This device complies with part 15 of the FCC Rules and Industry Canada license-exempt RSS standard(s).

Operation is subject to the following two conditions:

1. This device may not cause harmful interference, and
2. this device must accept any interference received, including interference that may cause undesired operation.

This device complies with the Nerve Stimulation Exposure Limits (ISED RSS-102) for direct touch operations. Changes or modifications not expressly approved by OMRON Corporation could void the user's authority to operate the equipment.

D41G

Structure and Nomenclature

Switch

D41G-□□D□-T1
D41G-□□D□-N2

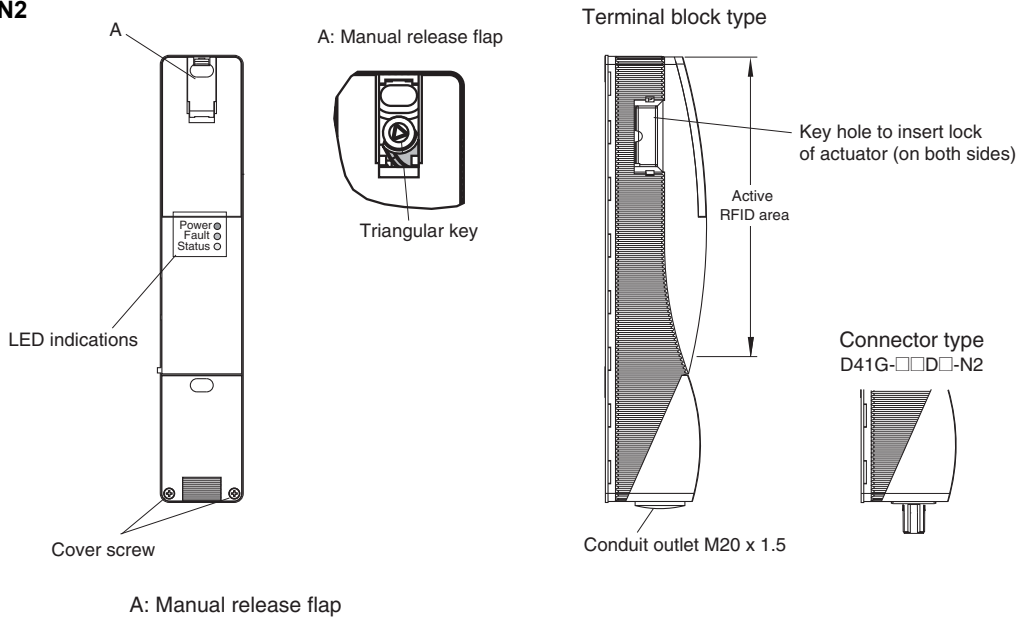

Actuator

D41G-A2□
D41G-A2□-E1
D41G-A2□-E1T

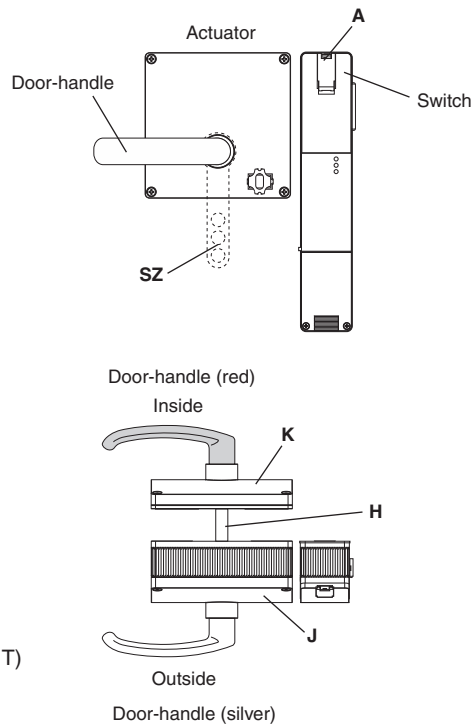

- A: Manual release flap
- J: Actuator unit with door-handle
- K: Emergency exit unit E1 (D41G-A2□-E1□)
- SZ: Lockout tag (optional, ordering D41G-A2□-E1T)
- H: Square rod (D41G-A2□-E1□)

Actuator

D41G-A1□
D41G-A1□-E0

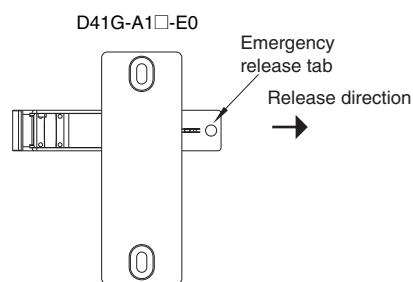
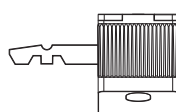
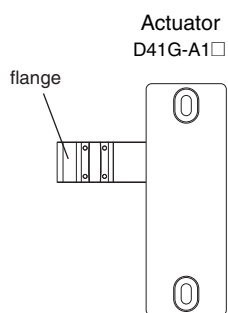
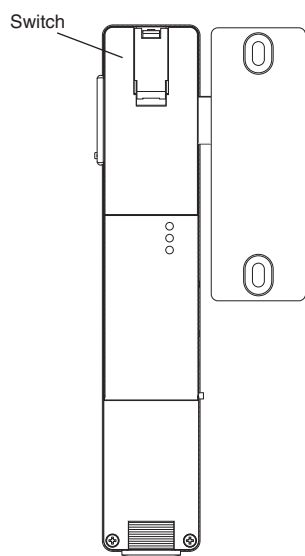

D41G

Connection

Pin assignment

Function		Pin configuration of the connector	Color code of the OMRON's connector to DIN 47100 D41L-8P5-CFM12-9□□M
24 V	U _e	1	WHITE
X1	Safety input 1	2	BROWN
GND	GND	3	GREEN
Y1	Safety output 1	4	YELLOW
OUT	Auxiliary output	5	GRAY
X2	Safety input 2	6	PINK
Y2	Safety output 2	7	BLUE
IN	Solenoid control	8	RED

Terminal block (D41G-□□□□-T1)

24V	24V	X1	X2	IN
D41G-□□□□-T1				
GND		Y1	Y2	OUT

Connector plug (D41G-□□□□-N2)

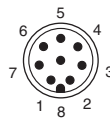

The cable entry is realized by a metric M20 gland. This gland must be measured by the user so that it is suitable for the cable used. A cable gland with strain relief and suitable IP protection class must be used. Length X of the cable at terminals: 8.0 mm (for screw terminals of -T1)

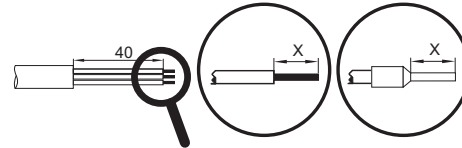

Wiring Example

The application examples shown are suggestions. However, these do not exempt the user from carefully checking whether the safety door switch and its set up are suitable for the individual application.

The power supply for the safety door switch must provide protection against permanent overvoltage. To that effect, stabilized PELV supply units must be used. The safety outputs can be directly connected in the safety circuit of the control system. For applications of PL e / safety category 4 in accordance with ISO 13849-1, the safety outputs of safety door switch or safety door switch of the chain must be connected to a safety controller or safety relay unit of the same Safety Category. Inductive loads (e.g. contactors, relays, etc.) are to be provided with suitable interference suppression circuitry.

If the safety door switch is wired to relays or to non-safety relevant control components, a new risk analysis must be carried out.

If the safety door switch is connected to the safety input of a safety controller or safety relay unit, the controller must have a dual-channel monitoring time of at least 100 ms and the accepted test pulse duration of at least 1 ms. Also, the cross-wire-short monitoring function must be disabled.

D41G series connection example

When connecting multiple safety door switches in series, apply 24 VDC to safety inputs X1 and X2 on the Nth unit, as shown in the figure below. Connect safety outputs Y1 and Y2 to safety inputs X1 and X2 of the following safety door switch.



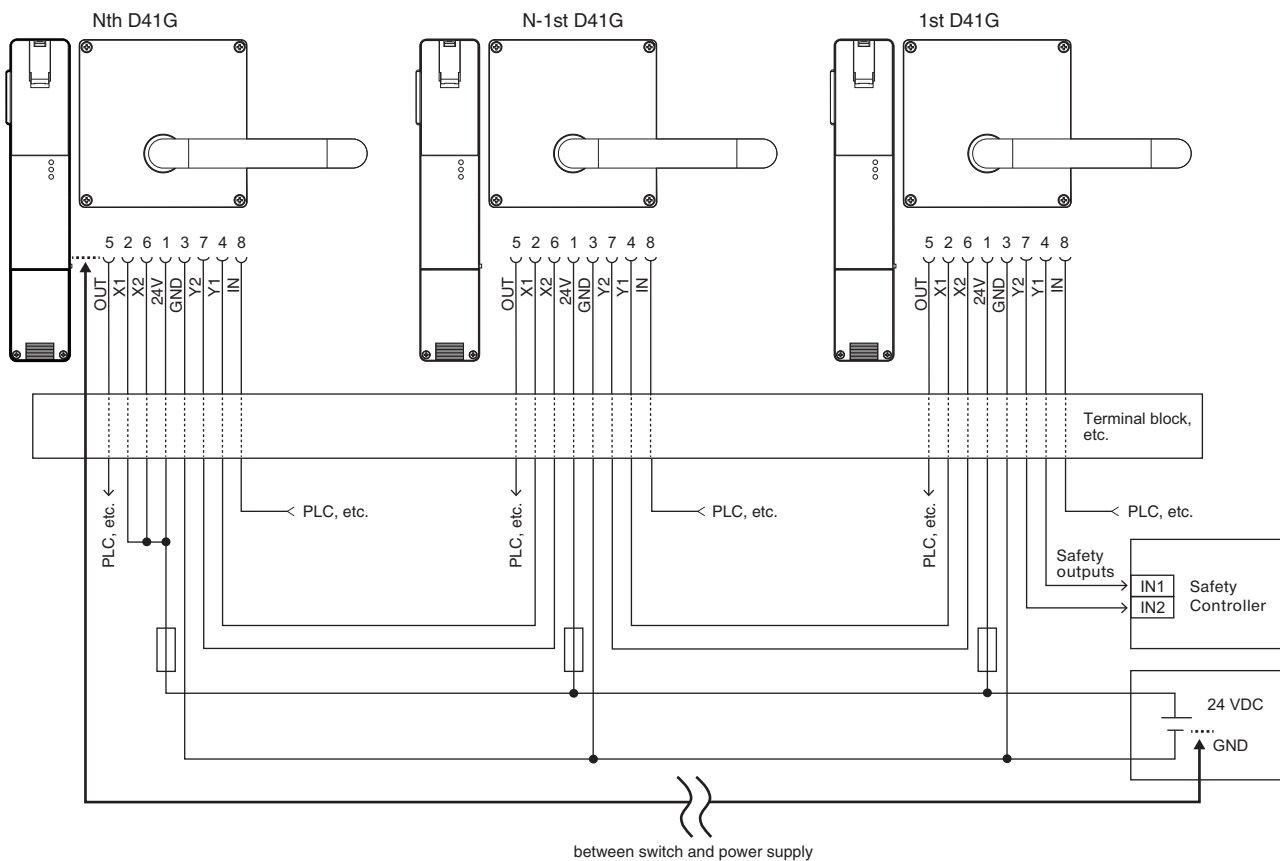

Connect safety outputs Y1 and Y2 of the first unit to the safety controller or safety relay unit.

Connect the auxiliary output to the PLC, etc.



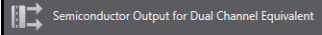
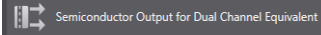

When connecting a single safety door switch to the safety controller or safety relay unit, apply 24 VDC to safety inputs X1 and X2 in the same manner as the Nth unit shown below, and then connect safety outputs Y1 and Y2 to the safety controller or safety relay unit.

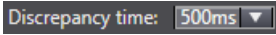
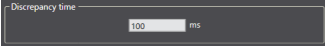
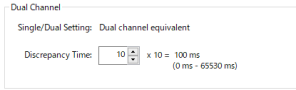
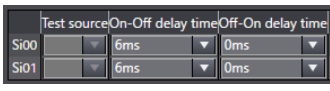
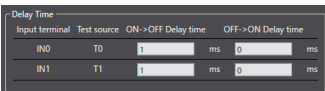

Safety controller settings

OMRON's safety controller		NX-SL and NX-SI 	GI-SMD/SID 	G9SP 
Input device setting	Input device	Semiconductor Output for Dual Channel Equivalent 	Semiconductor Output for Dual Channel Equivalent 	Dual Safety Semiconductor Output (Equivalent) 
	Discrepancy time	Set discrepancy time to 100 ms or more NX-Series Safety Control Unit User's Manual Refer to the Dual Channel Evaluation in No.Z930. 	Set discrepancy time to 100 ms or more GI-S series Safety I/O Terminal User's Manual Refer to the Dual Channel Evaluation in No.Z400. Example 	Set discrepancy time to 0 (disabled) or 100 ms or more G9SP series Safety Controller User's Manual Refer to the Dual Channel Evaluation in No.Z922. Example 
	Filtering out test pulses	Set input filter ON->OFF delay time to 1 ms or more NX-Series Safety Control Unit User's Manual Refer to the Input Filters in No.Z930. Example 	Set input filter ON->OFF delay time to 1 ms or more GI-S series Safety I/O Terminal User's Manual Refer to the Input Filter Function in No.Z400. Example 	Set input filter OFF delay time to 1 ms or more G9SP series Safety Controller User's Manual Refer to the Input Filters in No.Z922. Example Off On Delay: <input type="text" value="0"/> x 4 = 0 ms (0 ms - 1000 ms) On Off Delay: <input type="text" value="1"/> x 4 = 4 ms (0 ms - 1000 ms)

Combination with a safety relay unit

OMRON's safety relay unit		G9SA 	G9SE 	G9SB 	G9SX 
Input device Safety door switch	D41G	Connectable	Connectable	Connectable	Connectable

* Refer to the instruction manual or user's manual of each product for how to extend the wiring.

Release

Manual Release

For the machine set up, the safety door switch can be unlocked in a de-energized condition. After opening of the manual release cover "A" (refer to image *Dimensions* on page 17), the triangular key must be turned clockwise to bring the blocking bolt in unlocking condition. The normal locking function is only restored after the triangular key has been returned to its original position.

Component ready
for operation

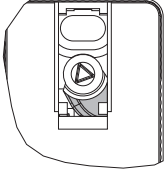

Component not ready
for operation

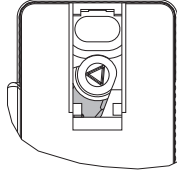

D41G

Teaching

Individually coded safety door switch and actuators will require the following teach-in procedure:

1. Keep the actuator away from the detection range and switch the safety door switch's voltage supply off and back on.
2. Introduce the actuator in the detection range. The teach-in procedure is signaled at the safety door switch, green LED off, red LED on, yellow LED flashes (1 Hz).
3. After 10 seconds, the yellow LED gives brief cyclic flashes (3 Hz). Switch off the supply voltage of the safety door switch. (If the voltage is not switched off within 5 minutes, the safety door switch cancels the teach-in procedure and signals a false actuator by 5 red flashes).
4. Switch the supply voltage back on. The actuator must be detected once more in order to activate the taught actuator code. In this way, the activated code is definitively saved.

For ordering suffix D41G-1, the executed allocation of safety interlock and actuator is irreversible.

When the above procedure is attempted with a D41G-1 which already completed teaching, the teaching procedure will not start.

For ordering suffix D41G-2, the teach-in procedure for a new actuator can be repeated an unlimited number of times. When a new actuator is taught, the code, which was applicable until that moment, becomes invalid. Subsequent to that, the safety outputs will be disabled for ten minutes, thus providing for an increased protection against intentional tampering.

The green LED will flash until the expiration of the time (10 minutes) of the enabling inhibit and the detection of the new actuator. In case of power failure during the lapse of time, the 10-minutes tampering protection time will restart.

When the above procedure is attempted with a combination of D41G-2 and actuator which already completed teaching, the teaching procedure will not start.

Operating Principle

Operating Principle

Magnet control

In the power-to-unlock version of the D41G, the safety door switch is unlocked when the Solenoid Control signal (= 24 V) is set.

In the power-to-lock version of the D41G, the safety door switch is locked when the Solenoid Control signal (= 24 V) is set.

If the risk analysis indicates the use of a monitored interlock then a variant (D41G-□Y) with the monitored interlock is to be used, labelled with the  symbol.

The actuator monitoring variant (D41G-□Z) is a safety door switch with an interlock function for process protection.

Mode of operation of the safety outputs

In the D41G-□Y, the unlocking of the safety door switch causes the safety outputs to be disabled. The unlocked guard door can be relocked as long as the actuator is inserted in the D41G safety door switch; in that case, the safety outputs are re-enabled. The guard door must not be opened.

In the D41G-□Z, the opening of the guard door causes the safety outputs to be disabled.

Diagnostic Functions

Diagnostic LEDs

The safety door switch indicates the operating condition and faults by means of three-color LEDs located in the front surface of the safety door switch.

- Green (Power): Supply voltage on
- Yellow (Status): Operating condition
- Red (Fault): Error (refer to Table 2)

Safety door switch with auxiliary output

The auxiliary output OUT can be used for central visualization of operating states or control functions, e.g. in a PLC.

The auxiliary output is not a safety-related output.

Behavior of the diagnostic output

(Example: power-to-unlock version)

Input signal magnet control

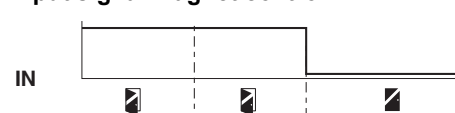







Normal sequence, door was locked



Door could not be locked or fault



Key

-  Guard door open
-  Unlock guard door
-  Locking time: 150 ... 250 ms, typically 200 ms
-  Guard door not locked or fault
-  Guard door closed
-  Guard door locked
-  Guard door not locked or fault

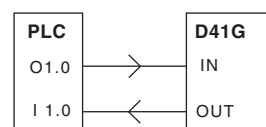

Power-to-unlock: IN = 0 = locking

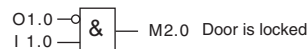

Power-to-lock: IN = 1 = locking

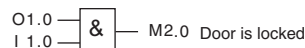

Table 2: Error messages / flash codes red diagnostic LED

Flash codes (Red)	Designation	Autonomous switch-off after	Error cause
1 flash pulse	Error (warning) at output Y1	30 min	Fault in output test or voltage at output Y1
2 flash pulses	Error (warning) at output Y2	30 min	Fault in output test or voltage at output Y2
3 flash pulses	Error (warning) cross-wire short	30 min	Cross-wire short between the output cables or fault at both outputs
4 flash pulses	Error (warning) temperature too high	30 min	The temperature measurement reveals an internal temperature that is too high
5 flash pulses	Actuator fault	0 min	Incorrect or defective actuator
6 flash pulses	Error actuator combination	0 min	An invalid combination of actuators was detected (blocking bolt detection or tamper attempt).
Continuous red	Internal fault / overvoltage or undervoltage fault	0 min	Device defective / supply voltage not within specifications

D41G

Actuator

Introduction

D41G-A

Mounting of the safety door switch and the actuator

Refer to the D41G actuator's Quick Installation Manual for the corresponding actuator.

The actuator must be permanently fitted to the guard doors and protected against displacement by suitable measures (tamper-proof screws, gluing, drilling of the screw heads).

Destination and Use

D41G-A2

In conjunction with the safety door switch D41G the actuator is suitable for hinged and sliding guard doors. The guard door can be opened and closed from outside by turning the door-handle.

The actuator is pulled into the actuator unit by a spring. The actuator unit with emergency exit is used to open the guard door inside the hazardous area. By actuating the emergency exit, the guard door can be opened from within the hazardous area without the need for unlocking the safety door switch D41G. The guard door cannot be locked from inside. On accessible protective equipment, the lockout tag prevents persons from being inadvertently being trapped. When entering the hazardous area, each member of the operating or service team fixes a lock to the lockout tag to prevent the locking of the guard door and therefore any inadvertent machine start.

Holding force F_{zh}
- mounting outside 2,000 N

D41G-A1

Actuators D41G-A1 is the preferred choice for use on sliding guard doors.

Actuator D41G-A1-E0 only suitable for the safety door switch D41G with concealed installation.

Emergency exit E0 (emergency release tab)

On the actuator with emergency exit, D41G-A1-E0, pulling the emergency release tab in the direction of arrow (see diagram) unlocks the D41G safety door switch whereupon the guard system can be opened.

When the guard door is closed, it is immediately re-locked. The autonomous, spring-loaded return of the unlocking mechanism, which is installed by the builder, must be guaranteed.

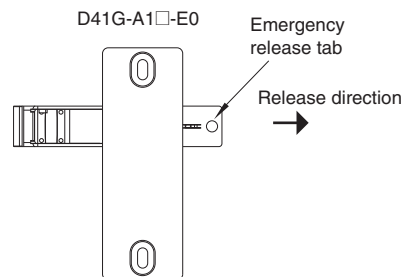

Dimensions

Switches

D41G-□□D□-T1
 D41G-□□D□-N2

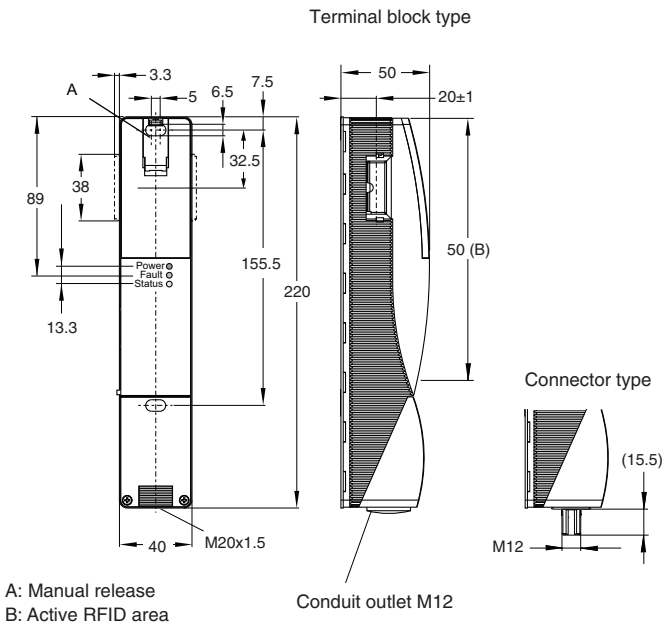

Actuator (Sold separately)

D41G-A2□
 D41G-A2□-E1
 D41G-A2□-E1T



ex. D41G-A2L-E1T (For left door) *

Mounting outside

Safety door switch D41G with actuator unit mounted outside the hazardous area

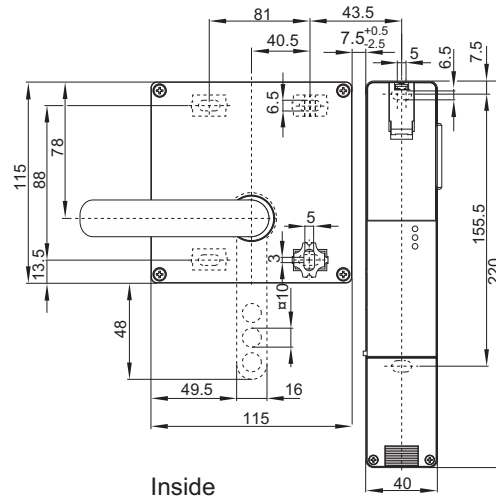

Inside

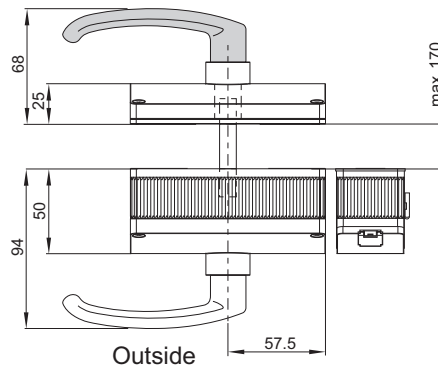

Outside

Interior view: Emergency exit unit E1

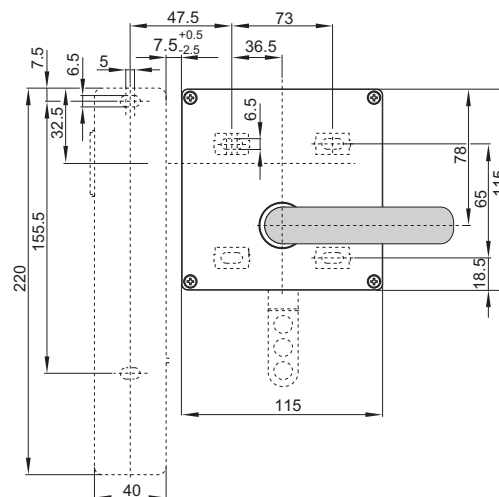

* The D41G-A2□ (without -E1□) does not come with an inside handle.
 * The above shows the model for a left door.
 The locking part position of the D41G-A2R (-E1□) for a right door is reversed.

D41G-A1□



For light door

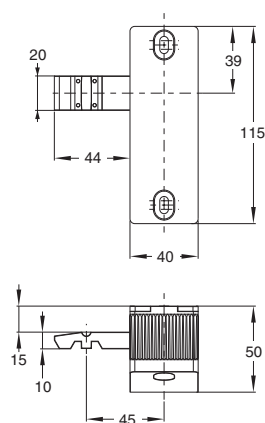

D41G-A1□-E0



For light door

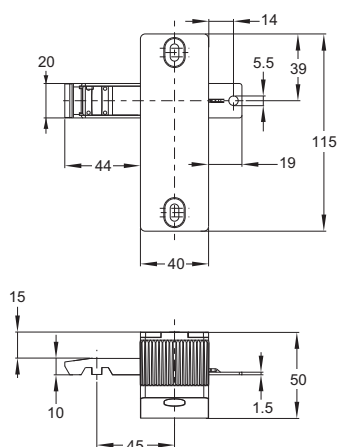

Example of mounting actuator
D41G-□□□□-□□+D41G-A1□



For light door

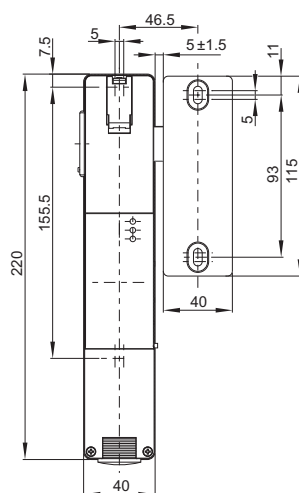

* The above shows the model for a light door. The locking part position of the D41G-A1R (-E0) for a right door is reversed.

D41G

Mounting

For fitting the safety door switch, two mounting holes for M6 screws with washers (washers included in delivery) are provided (tightening torque: 8 N·m). The safety door switch must not be used as a door stopper.

Any mounting position. The mounting position, however, must be chosen so that the ingress of dirt and soiling in the used opening is avoided. The unused actuator opening must be sealed by means of the dust-proof cover (included in delivery).

Minimum distance between two safety door switches

as well as other systems with same frequency (125 kHz): 100 mm.

D41G-A2

Admissible mounting set-up

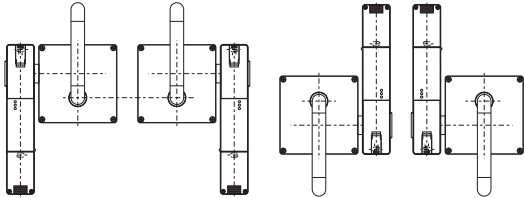

Inadmissible mounting set-up

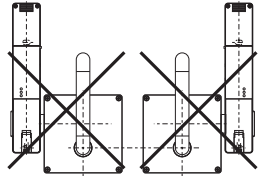

Mounting play between safety door switch and actuator

Actuator unit play

- X = ± 1.5 mm
- Y = ± 5.0 mm
- Z = ± 1.0 mm

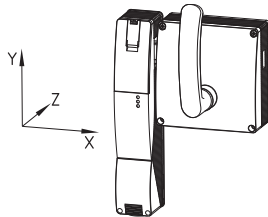

Representation of installation options

Actuators D41G-A2 is available for exterior installation.

The safety door switch D41G is placed outside the hazardous area.

With emergency exit	Right door	
	Left door	
Without emergency exit	Right door	
	Left door	

The minimum radius of the door is 400 mm.

Assumptions:

40 mm profile

- Distance between safety door switch and actuator unit: 7.5 mm.
- Use standard hinge for 40 mm profile.

Mounting method

D41G-A2

If there are any differences with the versions these are indicated with notes or additional sketches.

- To free mounting holes, unscrew the cover C for the wiring compartment and open flap A for the manual release.

To be observed:

- For exterior installation: Actuation of manual release (beneath flap A) with triangular key (included in delivery with safety door switch D41G)

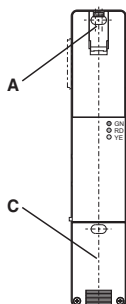

- Mount enclosure of safety door switch D41G flush with doorpost.

To be observed:

- Screws M6 (not included in delivery with safety door switch D41G)
- Tightening torque for safety door switch: 8 N·m
- Tightening torque for cover screw: 0.7 to 1 N·m (Torx T10)
- Wall thickness of the device: 19 mm
- Washers 6.4-dia (included in delivery with safety door switch D41G)
- For applications with strong vibrations, please observe a proper securing of the screws.

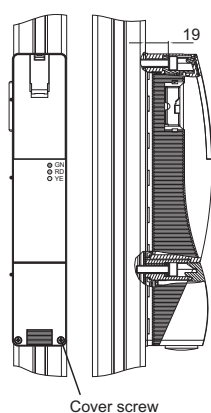

- Insert sliding blocks (included in delivery with actuator unit D41G-A2) as shown.

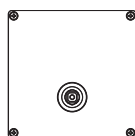

- Insert sliding blocks (included in delivery with actuator unit D41G-A2) as shown.

Observe the alignment (notch) of the sliding blocks.

- E: Left door
- D: Right door

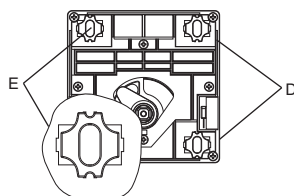

- Fit the actuator unit to the doorpost by means of the spacer F (7.5 mm)

To be observed:

- Actuator unit completely retracted
- Distance between safety door switch and actuator unit or emergency exit: 7.5 +0.5/-2.5 mm
- Screws M6 (not included in delivery with safety door switch D41G)
- Torque: 8 N·m
- Wall thickness of actuator: 8 mm (see step 11)
- Washers 6.4-dia (included in delivery with D41G-A2)
- For applications with strong vibrations, please observe a proper securing of the screws.

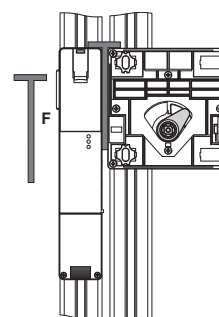

- Mount the cover on the actuator unit

To be observed:

- Actuator unit completely retracted

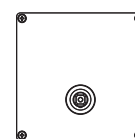

- Fit the door-handle

- Mount the door handle or emergency exit E1 horizontally
- D: for left door
- E: for right door
- G: Hexagonal screw A/F 3 with screw-lock (included in delivery with D41G-A2)
- For the model with suffix -E1T, attach the included lockout tag (SZ) at the same position as shown in the figure below, and then attach the resin ring and handle.
- For outdoor installation without emergency exit continue to step 14

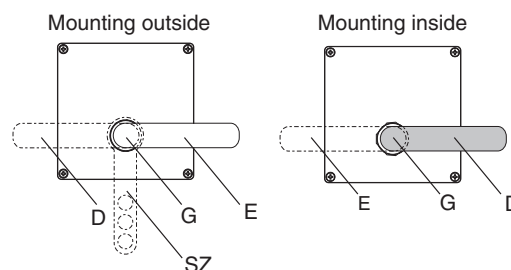

8. If an emergency exit is available, cut square tube H at length. De-burr the cut sides.

To be observed:

- Maximum door leaf thickness S: 170 mm
- Length of sawn off square rod H

Mounting outside

P1: $L = S + 22 - 2 \text{ mm}$

- Through-hole for square tube H: $\varnothing 16 \text{ mm}$

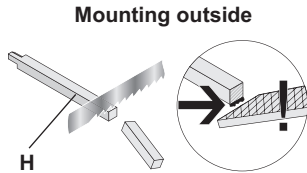

9. Unscrew the cover of the emergency exit E1

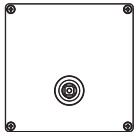

10. Insert sliding blocks as shown (included in delivery with D41G-A2)

To be observed:

Observe the alignment (notch) of the sliding blocks

- D: for left door
- E: for right door

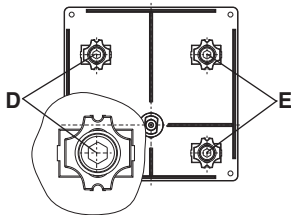

11. Fit the bottom plate of the emergency exit E1 to the door

To be observed:

- Actuator completely in J (actuator unit or emergency exit unit) retracted
- Arrange both the emergency exit and the actuator unit parallel
- Screws M6
- Tightening torque: 8 N·m
- Wall thickness of the device: 8 mm
- Washers 6.4-dia (included in delivery with D41G-A2)
- For applications with strong vibrations, please ensure the screws are correctly secured.

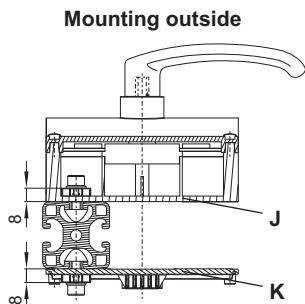

12. Insert square rod H in the backside of the actuator

To be observed:

For mounting outside: Insert chamfer of square into emergency exit or insert cut side of square into actuator unit. Position of the chamfer as shown, when actuator unit is actuated.

Mounting outside

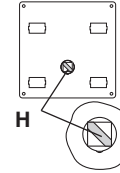

13. Fit the cover and the handle onto the emergency exit

To be observed:

- Position of the driving shaft I as shown, when actuator unit is actuated.
- Functional test of the emergency exit handle: it should be possible to open the guard door inside the hazardous area; it should not be possible to lock the guard door from inside. The emergency exit handle must be in upright position when closed.

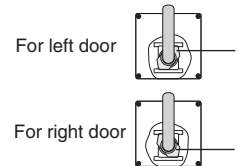

14. Clip the dust-proof flap in the unused side.

To be observed:

- M: for left door
- N: for right door

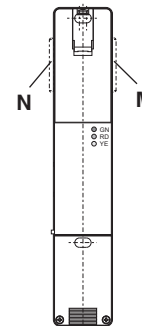

15. After being set up, secure the cover A of the manual release with the seal, which is included in delivery with safety door switch D41G.

Seal the cover of the manual release A

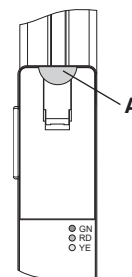

D41G-A1

The actuator D41G-A1 is mounted with a return spring. The spring travel is maximum 5 mm. The distance between the flange of the actuator and the switch enclosure must be 5 ± 1.5 mm with the actuator inserted.

1. Unscrew cover C for the wiring compartment and open the manual release flap A.

To be observed

Actuation of manual release with triangular key
(included in delivery with safety door switch D41G)

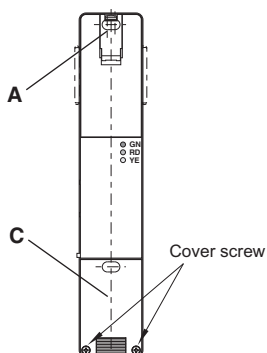

2. Mount enclosure of safety door switch D41G flush with doorpost.

To be observed

- Screws M6 (not included in delivery with safety door switch D41G)
- Washers 6.4-dia (included in delivery with safety door switch D41G)
- Tightening torque for safety door switch: 8 N·m (A)
- Tightening torque for cover screw: 0.7 to 1 N·m (Torx T10) (B)
- Wall thickness of safety door switch: 19 mm
- For applications with strong vibrations, please observe a proper securing of the screws

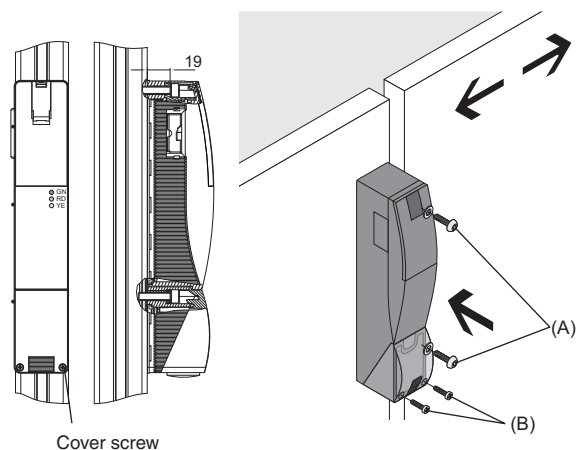

Cover screw

3. Fit the actuator to the doorpost.

To be observed

- Actuator with emergency exit (emergency release tab) D41G-A1-E0 may only be installed concealed.
- Top side of the safety door switch D41G flush with actuator top side
- Distance between safety door switch D41G and actuator: 5 ± 1.5 mm
- Screws M6 (not included in delivery with safety door switch D41G)
- Washers 6.4-dia (included in delivery with actuator D41G-A1)
- Wall thickness of actuator: 8 mm
- Tightening torque 8 N·m (C)
- For applications with strong vibrations, please observe a proper securing of the screws

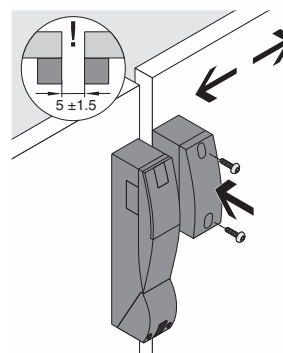

4. Clip the dust-proof cover in the unused side.
(included in delivery with safety door switch D41)

To be observed

M: for left door

N: for right door

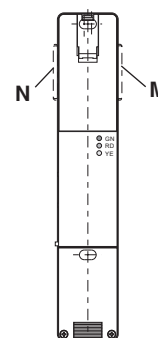

5. Seal the cover.

To be observed

After being put into operation, the manual release must be secured by installing the seal, which is included in with safety door switch D41G.

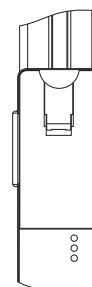

Troubleshooting

Error

Errors that no longer guarantee the function of the safety door switch (internal errors) cause the safety outputs to be disabled immediately. Any error that does not immediately affect the safe functionality of the safety door switch (e.g. too high ambient temperature, interference potential at the safety outputs, cross-wire short) will lead to a warning message, disabling of the auxiliary output and a delayed shutdown of the safety outputs. (Refer to Table 2.)

After fault rectification, the Switch can be reset by opening and relocking the relevant guard door. The safety outputs enable and allow a restart. An interlocking chain of the safety door switch must be "locked" to enable the reactivation.

Automatic, electronic locking takes place if more than one fault is detected at the safety outputs or a cross circuit is detected between Y1 and Y2. To reset this type of interlocking, the safety door switch must be isolated from the power supply after elimination of the error causes.

Error warning

A fault has occurred, which causes the safety outputs to be disabled after 30 minutes. The safety outputs initially remain enabled. This signal combination, auxiliary output disabled, and safety channels still enabled, can be used to stop the production process in a controlled manner. An error warning is deleted when the cause of error is eliminated.

Table 1: Diagnostic information for the safety switch

The safety switch signals the switching condition as well as malfunctions via three coloured LEDs installed on the device.

System condition	Solenoid control (IN)		LED			Safety outputs Y1, Y2		Auxiliary output OUT
	Power-to-unlock	Power-to-lock	Green	Red	Yellow	D41G-□Y	D41G-□Z	
Door open	24 V (0 V)	0 V (24 V)	On	Off	Off	0 V	0 V	0 V
Door closed, actuator not inserted	24 V	0 V	On	Off	Off	0 V	0 V	0 V
Door closed, actuator inserted, not locked	24 V	0 V	On	Off	Flashes	0 V	24 V	24 V
Door closed, actuator inserted, interlocking blocked	0 V	24 V	On	Off	Flashes	0 V	24 V	0 V
Guard closed, actuator inserted and locked	0 V	24 V	On	Off	On	24 V	24 V	24 V
Error warning (*1) safety door switch locked	0 V	24 V	On	Flashes *2	On	24 V *1	24 V *1	0 V
Error	0 V (24 V)	24 V (0 V)	On	Flashes *2	Off	0 V	0 V	0 V
Additionally for variant D41G-1/-2:								
Teach-in procedure actuator started			Off	On	Flashes	0 V	0 V	0 V
Only D41G-2: Tampering protection time *3			Flashes	Off	Off	0 V	0 V	0 V

*1. After 30 min: disabling due to fault

*2. Refer to flash code

*3. Refer to Teaching.

Table 2: Error messages / flash codes red diagnostic LED

Flash codes (Red)	Designation	Autonomous switch-off after	Error cause
1 flash pulse	Error (warning) at output Y1	30 min	Fault in output test or voltage at output Y1
2 flash pulses	Error (warning) at output Y2	30 min	Fault in output test or voltage at output Y2
3 flash pulses	Error (warning) cross-wire short	30 min	Cross-wire short between the output cables or fault at both outputs
4 flash pulses	Error (warning) temperature too high	30 min	The temperature measurement reveals an internal temperature that is too high
5 flash pulses	Actuator fault	0 min	Incorrect or defective actuator
6 flash pulses	Error actuator combination	0 min	An invalid combination of actuators was detected (blocking bolt detection or tamper attempt).
Continuous red	Internal fault / overvoltage or undervoltage fault	0 min	Device defective / supply voltage not within specifications

Safety Precautions



Be sure to read the precautions for all models in the website at: <http://www.ia.omron.com/>.

Indication and Meaning for Safe Use

Warning Indications

 WARNING	Indicates a potentially hazardous situation which, if not avoided, will result in minor or moderate injury, or may result in serious injury or death. Additionally there may be significant property damage.
Precautions for Safe Use	Supplementary comments on what to do or avoid doing, to use the product safely.
Precautions for Correct Use	Supplementary comments on what to do or avoid doing, to prevent failure to operate, or undesirable effect on product performance.

Meaning of Product Safety Symbols

	General prohibition Instructions on unspecified prohibited action.
	General instructions Instructions on unspecified general action.

WARNING

Use only appropriate components or devices complying with relevant safety standards corresponding to the required performance level and safety category. Failure to do so may result in serious injury or death. Conformity to requirements of the performance level and safety category must be determined as an entire system. It is recommended to consult a certification body regarding assessment of conformity to the required safety level. 

Do not apply DC voltages exceeding the rated voltages, nor any AC voltages to the product. Failure to do so may result in serious injury or death. 

Install the switch and actuator in a position where the opening of the guard door can be detected within a safe distance. Failure to do so may result in serious injury or death. 

Do not apply force exceeding the specified holding force (F_{zh}). Either install another locking component (e.g., a hook) in addition to the product, or use a warning measures or an indicator showing the controlled system is locked to avoid overloading the holding force in lock mode. Failure to do so may result in serious injury or death. 

When complying with safety standards, install the product in an appropriate manner in accordance with ISO 14119, with due consideration of the risk of defeat by the operator. Failure to do so may result in serious injury or death. 

Make sure that the DC power supply meets the following items. Failure to do so may result in serious injury or death. 

- Satisfies the requirements of PELV power supply defined in IEC 60204-1.
- Satisfies the requirements of class 2 circuits defined in UL508.

Precautions for Safe Use

1. Disconnect the product from power supply when wiring the product. Failure to do so may cause unexpected operation of devices connected to the product.
2. Wire the input and output terminals correctly and verify the correct operation of the product before using the system in which the product is incorporated. Incorrect wiring may lead to loss of the safety function.
3. Install the actuator in a place where it will not come in contact with your body when opening or closing the guard door. Failure to do so may result in injury.
4. Do not use the product in any direction other than the specified mounting orientations of the main body and actuator.
5. Dispose of the product in accordance with the laws set by each country.
6. When the door is closed (with the actuator inserted), the actuator may be pushed back beyond the mounting play due to the weight of the door or the cushioning rubber of the door. Secure the door with a hook or by similar means so that it stays within the mounting play. (Refer to the D41G actuator's Quick Installation Manual.)

Precautions for Correct Use

1. Do not drop the product to the ground or expose to excessive vibration or mechanical shocks. Doing so may damage the product and cause failure.
2. Do not store or use the product under the following conditions. Doing so may damage the product and cause failure.
 - 1) At ambient operating temperatures out of the range of -10 to 55°C
 - 2) At ambient storage temperatures out of the range of -10 to 55°C
 - 3) At relative humidity of 93% or more
 - 4) In direct sunlight
 - 5) Under drastic temperature changes
 - 6) In high humidity that causes condensation
3. Keep the product away from oil or solvent. Oil or solvent make the marking on the product illegible and cause deterioration of some parts.
4. Do not use in an environment with corrosive gas.
5. The product may not operate normally in the vicinity of devices that generate strong radio waves or magnetic fields, such as RFID systems, proximity sensors, motors, inverters, and switch-mode power supplies. If the device is used in the vicinity of such devices, check the effect before use.
6. Installing the switch and the actuator on a metallic material may affect the operating distance. If installation on a metallic material is necessary, be sure to check the effect on the operating distance before use.
7. Tighten the screws with a specified torque.
8. Use the wires specified by OMRON to wire the product. (Refer to *Connection* on page 10.)
9. Do not extend the cables in excess of the specification of this product. Carry out electrical connection according to the wiring examples shown in this document and verify the correct operation of the product.
10. Do not pull or bend the cable excessively. A disconnection may cause a malfunction.
11. Risk time remains unchanged by series connection. However, carry out electrical connection according to the wiring examples shown in this document.
12. Be sure to inspect the product daily and every 6 months. Failure to do so may cause a system failure and serious injury.
13. When determining the safety distance, take into account the delay of the output of the product caused by the response time. Failure to do so may cause the operator to reach the hazardous source before the machine is stopped, resulting in serious injury.
14. During installation, make sure that the safety door switch does not come in contact with the actuator due to rattling of the guard door. (The performance of the product may be degraded by a collision caused by opening or closing the guard door.)
15. Install the product so that the LED indicators of the safety door switch are as visible as possible. Misinterpreting the status of the safety door switch may result in danger.

16. Do not use the product at an altitude of 2,000 m or higher.
17. Do not connect a product different from this product in series with this product. Doing so may disturb waveforms of the input and output signals, leading to loss of the safety function.
18. Do not use the product in the water or continuous water exposure environment. Doing so may cause water to leak into the product. (The degree of protection does not guarantee the protection under continuous water exposure environment.)
19. Do not tamper the product with a replacement actuator. Store replacement actuators in a safe place where they cannot be easily reached.
20. Build a safety system using the outputs of both Safety Outputs 1 and 2. Wiring with only one safety output may lead to loss of the safety function due to a single failure.
21. Wiring should meet the requirements specified in Section 9.4.3 of IEC 60204-1 to prevent malfunction due to ground faults in the safety output lines.
22. In the power-to-lock type, close the door before energizing the safety door switch.
23. In the power-to-lock type, the safety door switch is locked only when the solenoid is energized. If the solenoid is de-energized due to a sudden power failure, the operator may be exposed to a hazardous source. Use the power-to-lock type only for process protection.
24. Do not use the emergency-exit type for switching the machine on and off. Doing so may place operators at risk due to being trapped inside or unexpected operation of the machine.
25. Install the emergency-exit type so that it cannot be operated from outside a safety zone.
26. Do not apply excessive force on the actuator while the actuator is inserted into the switch body or do not drop the product. Doing so may deform the actuator or damage the switch body.
27. Insert the actuator with a tolerance of $\pm 1.5\text{mm}$ for X, $\pm 5.0\text{mm}$ for Y and $\pm 1.0\text{mm}$ for Z to the center of the key hole. Misalignment or tilting may cause premature wear or damage. (Refer to the D41G actuator's Quick Installation Manual for the corresponding actuator.)
28. The safety function may not operate normally due to a malfunction of the wiring, setting, or switch, and the machine may continue to operate, which may result in personal injury. Make sure that the safety function works before starting operation.
29. Do not pull on lead wires with excessive force. Doing so may cause loose connection.
30. The current consumption of the safety door switch is different between when it is turned on and when it is in a normal operation. Apply the supply voltage to the safety door switch in consideration of the voltage drop in the wiring.
31. Do not turn beyond the latching point. After being put into operation, the manual release must be secured by closing the cover with the seal, which is included in delivery.
32. After installation of the product, qualified personnel should verify to see that the installation, inspection, and maintenance are properly performed. The qualified personnel should be qualified and authorized to secure the safety on each phase of design, installation, running, maintenance and disposal of system.
33. Do not wire the product to an input of a safety controller in parallel.
34. Disconnect the product and the controller connected to the product from power supply when replacing the product. Failure to do so may cause unexpected operation of devices connected to the product.
35. Install the product to a position near a handle of the guard door. Installing it near a hinge may cause the locking part of the product to receive larger load than the operating force, leading to damage to the locking mechanism.
36. Do not use the product as a door stopper. (The performance of the product may be degraded due to a collision caused by opening and closing the guard door.)
37. Do not try to disassemble, repair, or modify the product. Doing so may cause loss of the safety function.
38. Be sure to attach the cover after wiring work. Also, do not energize with the cover open. There is a risk of electric shock.
39. Do not operate the product in an environment with flammable or explosive gas.
40. Auxiliary output is NOT a safety output. Do not use the Auxiliary output individually for any safety function. Such incorrect use causes loss of the safety function of the product and its relevant systems.

Set-up and Maintenance/Disassembly and Disposal

Set-up and Maintenance

Functional testing

The safety function of the safety components must be tested. The following conditions must be previously checked and met:

1. Fitting of the Switch and the actuator
2. Check the integrity of the cable entry and connections
3. Check the switch enclosure for damage

Maintenance

Maintenance frequency

SIL3 / PLe at least once a month

SIL2 / PLd at least once a year

(Daily inspection)

- For each guard door, check that the machine stops when the guard door opens. (Inspection every 6 months)
1. Check for tight installation of the safety door switch and the actuator.
 2. Check maximum axial offset of the safety door switch and the actuator.
 3. Remove particles of dust and soiling
 4. Check cable entry and connections

Disassembly and Disposal

Disassembly

The product must be disassembled in a de-energized condition only.

Disposal

The product must be disposed of in an appropriate manner in accordance with the national prescriptions and legislations.

High-Coded Safety Door Switch

OMRON
High-Coded Non-Contact Safety Door Switch
D41D

Matches with machine design. Initial setup by batch pairing is quick and easy.

- Tamper-proof safety door switch to prevent human error
- Easy automatic pairing
- Fits in narrow spaces and corners inside machines
- Three types of actuators
- Complies with ISO 14119 (Type 4 High-Coded), ISO 13849-1 (PLd)

The switch is well-suited for the most common applications of high-coded safety doors.

Notes to Safety Practitioners - see page 11

Three types of actuators fit in narrow spaces and corners inside machines

D41D-A High-coded non-contact magnetic door switch
• Fits in narrow spaces and corners

D41D-B High-coded magnetic single-throw glass door switch
• Flat design makes for easy installation

D41D-C High-coded non-contact sliding door switch
• Compact size for single-glass doors

Features

- Large variety of terminals
- Supports bidirectional communication
- Supports 1000 Hz carrier frequency
- Supports 1000 Hz carrier frequency
- Supports 1000 Hz carrier frequency
- Supports 1000 Hz carrier frequency

ISO 13849-1 (PLd)

- Supports 1000 Hz carrier frequency
- Supports 1000 Hz carrier frequency
- Supports 1000 Hz carrier frequency
- Supports 1000 Hz carrier frequency

ISO 14119 (Type 4 High-Coded)

- Supports 1000 Hz carrier frequency
- Supports 1000 Hz carrier frequency
- Supports 1000 Hz carrier frequency
- Supports 1000 Hz carrier frequency

CE

A high-coded safety switch is defined as one where a switch is paired with a high-level coded actuator for which more than 1,000 combinations are available.

omron

High-Coded Non-Contact Safety Door Switch
D41D

OMRON
High-Coded Guard Lock Safety Door Switch
D41L

Keep your machines hygienic

- Tamper-proof safety door switch to prevent human error
- Hygienically designed switch
- Unique locking mechanism prevents water and foreign matter from collecting
- Smooth surface makes on-siting easier
- Complies with ISO 14119 (Type 4 High-Coded), ISO 13849-1 (PLd), IEC60361 certified

The switch is well-suited for the most common applications of high-coded safety doors.

Notes to Safety Practitioners - see page 11

Identical mounting for left and right hinged doors

Features

- Large variety of terminals
- Supports bidirectional communication
- Supports 1000 Hz carrier frequency
- Supports 1000 Hz carrier frequency
- Supports 1000 Hz carrier frequency
- Supports 1000 Hz carrier frequency

ISO 13849-1 (PLd)

- Supports 1000 Hz carrier frequency
- Supports 1000 Hz carrier frequency
- Supports 1000 Hz carrier frequency
- Supports 1000 Hz carrier frequency

ISO 14119 (Type 4 High-Coded)

- Supports 1000 Hz carrier frequency
- Supports 1000 Hz carrier frequency
- Supports 1000 Hz carrier frequency
- Supports 1000 Hz carrier frequency

CE

A high-coded safety switch is defined as one where a switch is paired with a high-level coded actuator for which more than 1,000 combinations are available.

omron

High-Coded Guard Lock Safety Door Switch
D41L

OMRON
High-Coded Guard Lock Safety Door Switch (For Gate)
D41G

Prevent people from being trapped inside hazardous areas

- Tamper-proof safety door switch to prevent human error
- Integrated door handle structure reduces guarding design time
- Integrated handle's smooth operation enables quick emergency exit
- Switch can be activated when power supply is unavailable to avoid being trapped inside
- Complies with ISO 14119 (Type 4 High-Coded), ISO 13849-1 (PLd)

The switch is well-suited for the most common applications of high-coded safety doors.

Notes to Safety Practitioners - see page 11

Features

Application example

Emergency stop button (left)

Existing transition area (right)

Activate with integrated emergency exit

- High-coded safety switch
- High-coded safety switch
- High-coded safety switch
- High-coded safety switch

ISO 13849-1 (PLd)

- Supports 1000 Hz carrier frequency
- Supports 1000 Hz carrier frequency
- Supports 1000 Hz carrier frequency
- Supports 1000 Hz carrier frequency

ISO 14119 (Type 4 High-Coded)

- Supports 1000 Hz carrier frequency
- Supports 1000 Hz carrier frequency
- Supports 1000 Hz carrier frequency
- Supports 1000 Hz carrier frequency

CE

A high-coded safety switch is defined as one where a switch is paired with a high-level coded actuator for which more than 1,000 combinations are available.

omron

High-Coded Guard Lock (For Gate) Safety Door Switch
D41G

OMRON AUTOMATION AMERICAS HEADQUARTERS • Chicago, IL USA • 847.843.7900 • 800.556.6766 • automation.omron.com

OMRON CANADA, INC. • HEAD OFFICE
Toronto, ON, Canada • 416.286.6465 • 866.986.6766 • automation.omron.com

OMRON ELECTRONICS DE MEXICO • HEAD OFFICE
Ciudad de México • 52.55.5901.4300 • 01.800.386.6766 • mela@omron.com

OMRON ELECTRONICS DE MEXICO • SALES OFFICE
San Pedro Garza García, N.L. • 81.12.53.7392 • 01.800.386.6766 • mela@omron.com

OMRON ELECTRONICS DE MEXICO • SALES OFFICE
Eugenio Garza Sada, León, Gto • 01.800.386.6766 • mela@omron.com

OMRON ELETRÔNICA DO BRASIL LTDA • HEAD OFFICE
São Paulo, SP, Brasil • 55 11 5171-8920 • automation.omron.com

OMRON ARGENTINA • SALES OFFICE
Buenos Aires, Argentina • +54.11.4521.8630 • +54.11.4523.8483
mela@omron.com

OTHER OMRON LATIN AMERICA SALES
+54.11.4521.8630 • +54.11.4523.8483 • mela@omron.com