



## Part Number: D3C9521S

### Electrical Specifications

Frequency Range (GHz):	0.95 – 2.10
Isolation (dB):	12 MIN
Insertion Loss (dB):	1.0 MAX
VSWR:	1.65:1 MIN
Forward Power (W):	75 AVG 100 PK

### Mechanical/Environmental Specifications

Connector Type:	SMA
Connector Body:	Nickel plated brass
Connector Pin:	Gold plated copper
Load Body:	Brass
Magnetic Shunt:	Nickel plated CRS
Operational Temp:	+10°C to +55°C
Weight (oz)	15.0 MAX

### D3C9521S Dimensions

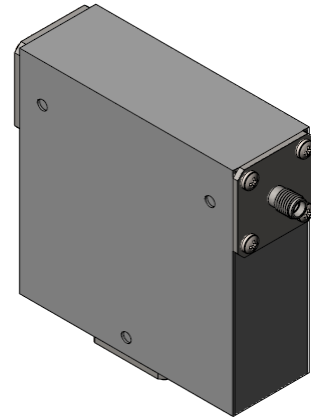
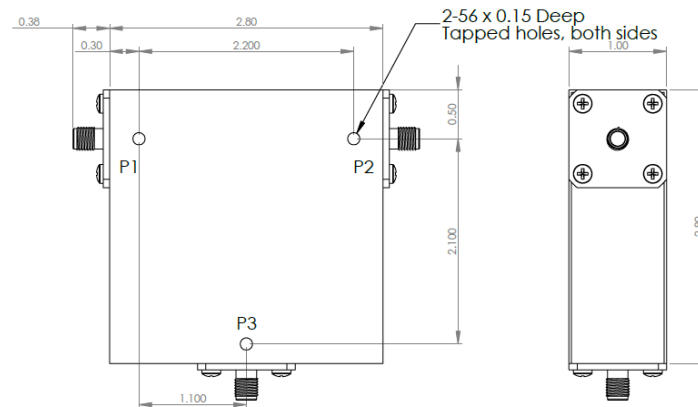

### D3C9521S-3 Dimensions

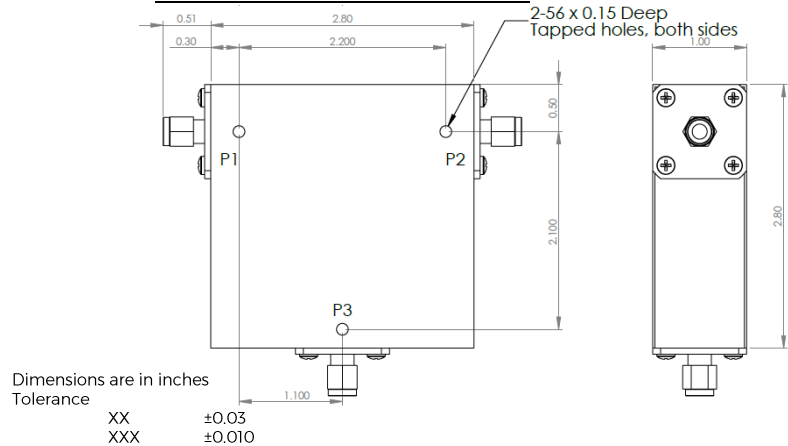

Type of Device	PN Suffix	Connector Configuration Input / Output	PN Example
Single Junction Circulator 3-Port Device Port 1 / Port 2 / Port 3	No Dash	Female / Female / Female	D3C9521S
	-1	Male / Female / Female	D3C9521S-1
	-2	Female / Male / Female	D3C9521S-2
	-3	Male / Male / Male	D3C9521S-3
	-4	Female / Female / Male	D3C9521S-4
	-5	Male / Female / Male	D3C9521S-5
	-6	Male / Male / Female	D3C9521S-6
	-7	Female / Male / Male	D3C9521S-7



## MEASURED DATA

Part Number: D3C9521S, P1→P2, P3 Terminated with 50Ω, +25°C

